



# THE FINIAL COMPANY™

Custom for Every Style

MODERN • TRANSITIONAL • TRADITIONAL

Drapery Hardware Catalog



## ◀ our standard finishes

The Finial Company offers a comprehensive range of sophisticated hand painted and plated finishes. Our 10 new artisan crafted finishes include a trend right mix of elegant rustic-inspired finishes, mid-tone neutrals and modern metallics that complement today's textiles, furnishings and home décor accessories. Our sample chip design shows both smooth and detailed surfaces, indicating how the finish will look on your selected product.

For your convenience, you can unfold this cover to view all of our standard finishes as you browse our product catalog.

## ◀ our process

We specialize in combining quality craftsmanship with elegant hand painted finish details that deliver a custom quality product every time. Products are hand painted after we receive your order. The entire order is painted together to ensure a consistent finish. The nature of hand finishing causes some acceptable variation in finish, as each order is truly one-of-a-kind.

For more details on Custom Finish Options, please refer to the Retail Price List. Our talented artisans enjoy the challenge of creating any finish that you can envision.



## custom designs inspired by you

For any design you envision, The Finial Company can make it a reality. From one-of-a-kind creations to our broad mix of hand crafted drapery hardware collections, you will never be limited by design styles, finish selections, window shapes or unusual floor plans. We've updated our expansive window hardware assortment with new finish options, customized details and modern finial designs; including the new Modern Metal Collection that offers over 400 innovative design combinations. Whether tailoring an existing style to fit your client's specific needs or bringing a new design to life inspired by your unique vision, our talented artisans are ready to help create any window design you can imagine.

THE FINIAL COMPANY™



## table of contents

### 3 metal

1 1/8"-1 3/8" modern metal collection	3
1 3/8" metal collection	10

### 15 steel

1/2" collection	15
3/4" collection	18
1" collection	25
1 1/4" collection	32
1 1/2"-1 3/4" collection	39
outdoor hardware	45

### 49 custom solutions

custom pole returns	50
custom steel brackets	56
custom accessories	57
custom arches	59
custom finishes	60

### 61 wood & resin

1 3/8" diameter collection	61
2"-2 1/4" diameter collection	68
3" diameter collection	81
rosettes	88
tiebacks	93
crests	94

### 95 traverse systems

light duty traverse	95
heavy duty traverse	98
motorized traverse	102
how to order traverse	108
display boards	110
how to measure	111
terms & conditions	112
index	113





1 1/8"

1 3/8"

## metal

1 1/8" - 1 3/8" modern metal collection 3

1 3/8" metal collection 10

actual pole sizes

1 1/8"

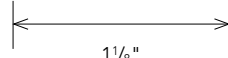
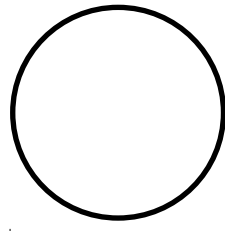

1 1/8"  
TFCM118

1 3/8"

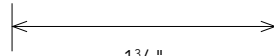
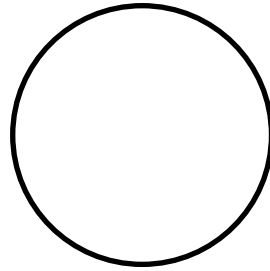

1 3/8"  
TFCM138

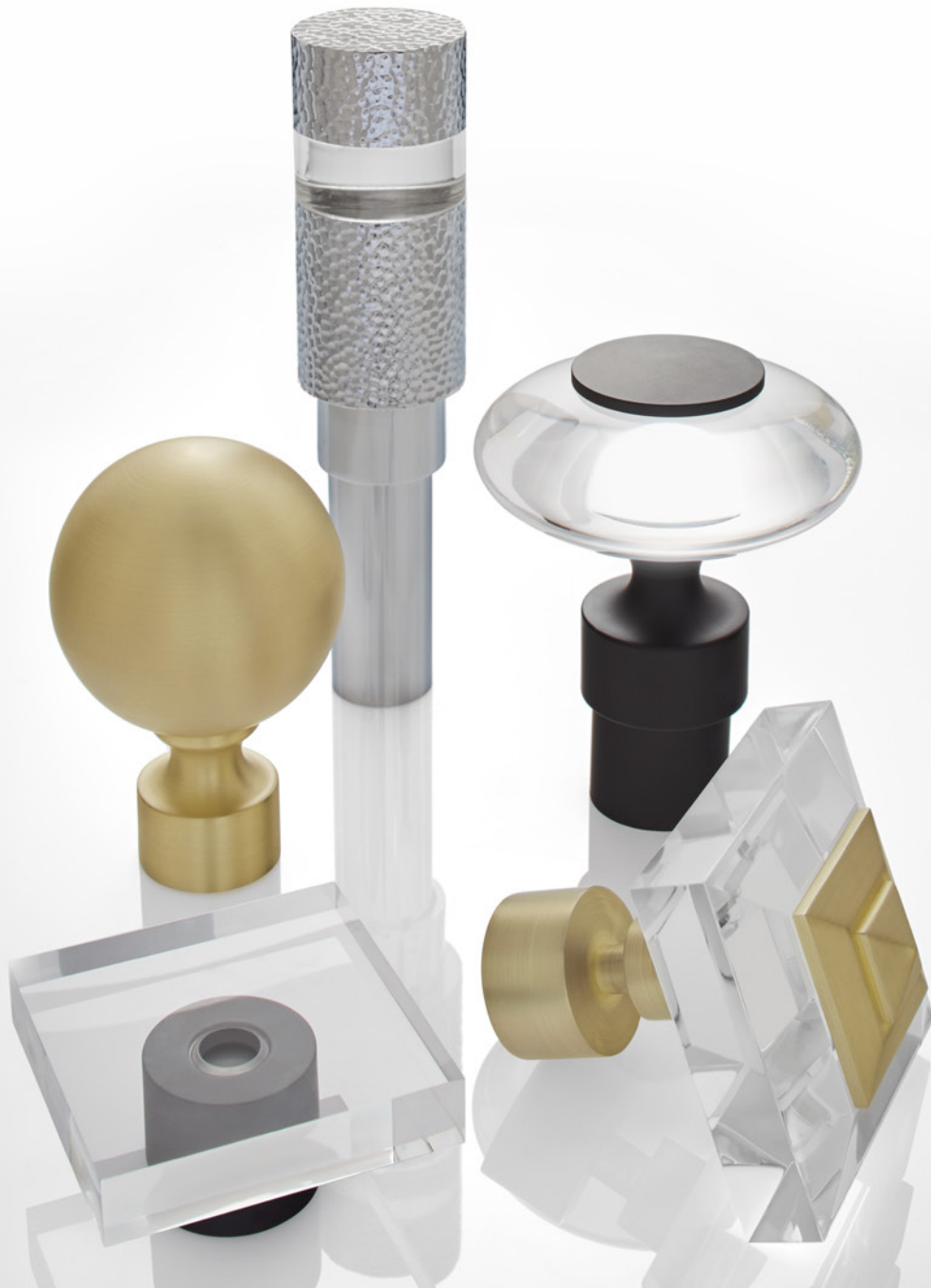

## 1<sup>1</sup>/<sub>8</sub>" - 1<sup>3</sup>/<sub>8</sub>" modern metal collection

The new Modern Metal Collection features clean lines and trend-right acrylic styles available in 5 contemporary finishes. Designed to be customized, the collection offers three mix & match cuff and collar options in 1<sup>1</sup>/<sub>8</sub>" and 1<sup>3</sup>/<sub>8</sub>" diameters that can be combined with any of our 14 finials to create sleek to soft modern styles in more than 400 design combinations.



1 1/8" - 1 3/8"  
modern metal

# modern metal design combinations

## 1

### Select Finial Design:

Modern Metal Collection finials are designed to coordinate with both 1 1/8" and 1 3/8" pole diameters.

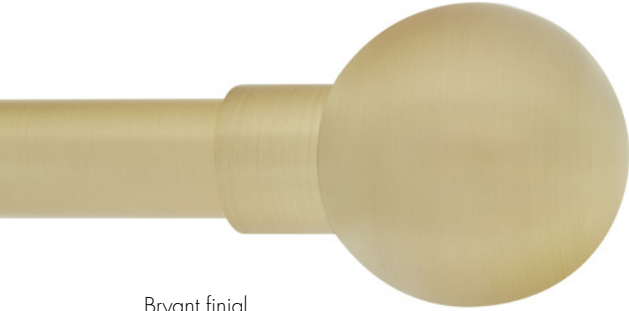

Bryant finial  
Satin Gold  
pictured with  
1 1/8" modern cuff  
in Satin Gold

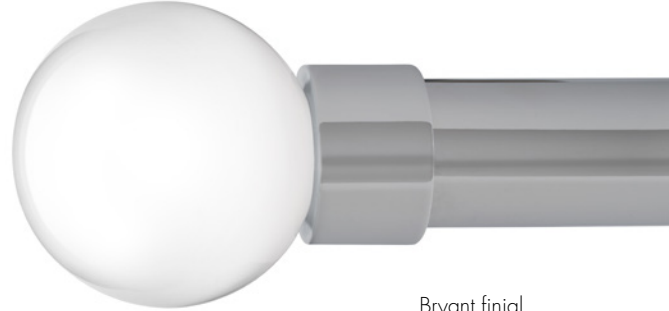

Bryant finial  
Acrylic  
pictured with  
1 3/8" modern cuff  
in Chrome

## 2

### Choose Pole Diameter:

1 1/8" and 1 3/8" poles are available in all 5 modern finishes.



Bryant finial  
Satin Gold  
pictured with  
1 1/8" modern collar  
in Satin Gold



Bryant finial  
Acrylic  
pictured with  
1 3/8" modern collar  
in Chrome

## 3

### Select a Cuff or Collar:

Select from any of our 3 cuff and collar designs in your pole diameter. Mix or match with our 5 modern finishes.

Sold separately on page 6.



Bryant finial  
Satin Gold  
pictured with  
1 1/8" transitional collar  
in Satin Gold



Bryant finial  
Acrylic  
pictured with  
1 3/8" transitional collar  
in Chrome

# 1 1/8" - 1 3/8" modern metal



**TFCM600** NEW  
**Bryant**  
 2 7/8" L x 2 3/4" W  
 Satin Gold  
 pictured with  
 1 1/8" modern cuff  
 and TFCM118 pole



**TFCM600/CL** NEW  
**Bryant Acrylic**  
 2 7/8" L x 2 3/4" W  
 pictured with  
 1 3/8" transitional collar  
 and TFCM138 pole  
 in Chrome



**TFCM601** NEW  
**Declan**  
 2 1/4" L x 2 1/4" W  
 Matte Black  
 pictured with  
 1 1/8" modern collar  
 and TFCM118 pole

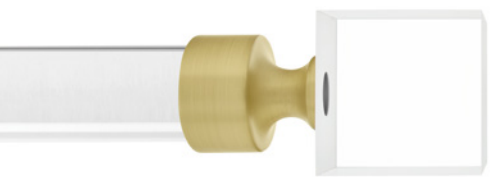

**TFCM601/CL** NEW  
**Declan Acrylic**  
 2 1/4" L x 2 1/4" W  
 pictured with  
 1 3/8" transitional collar  
 and TFCM138 pole  
 in Acrylic



**TFCM602** NEW  
**Upton**  
 4" L x 1 7/8" W  
 Brushed Nickel  
 pictured with  
 1 1/8" modern cuff  
 and TFCM118 pole



**TFCM602/CL** NEW  
**Upton Acrylic**  
 4" L x 1 7/8" W  
 pictured with  
 1 1/8" modern collar  
 and TFCM118 pole  
 in Brushed Nickel



**TFCM603** NEW  
**Delano**  
 4" L x 1 7/8" W  
 Brushed Black Nickel  
 pictured with  
 1 1/8" modern cuff  
 and TFCM118 pole



**TFCM604** NEW  
**Mercer**  
 4" L x 2 1/8" W  
 Satin Gold  
 pictured with  
 1 3/8" transitional collar  
 and TFCM138 pole

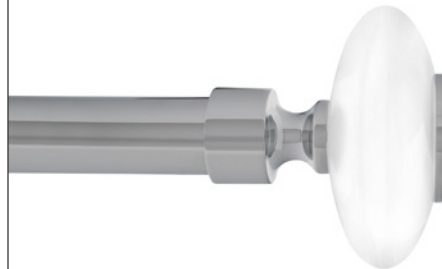

**TFCM605** NEW  
**Luca**  
 2" L x 3 3/4" W  
 Acrylic  
 pictured with  
 1 1/8" transitional collar  
 and TFCM118 pole  
 in Chrome



**TFCM606** NEW  
**Stiles**  
 2 3/8" L x 3" W  
 Acrylic  
 pictured with  
 1 3/8" modern collar  
 and TFCM138 pole  
 in Matte Black

# 1 1/8" - 1 3/8" modern metal



**TFCM691** NEW  
**Anson**  
 7/8"L x 3"W  
 Chrome pictured with  
 1 1/8" transitional collar  
 and TFCM118 pole



**TFCM691/CL** NEW  
**Anson Acrylic**  
 7/8"L x 3"W  
 pictured with  
 1 1/8" modern cuff  
 and TFCM118 pole  
 in Matte Black

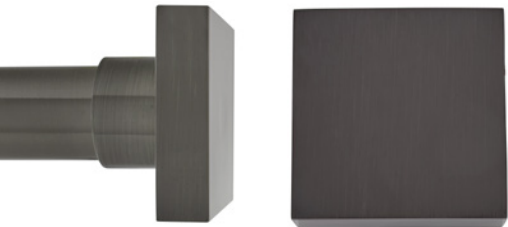

**TFCM692** NEW  
**Eason**  
 1"L x 2 7/8"W  
 Brushed Black Nickel  
 pictured with  
 1 3/8" modern cuff  
 and TFCM138 pole

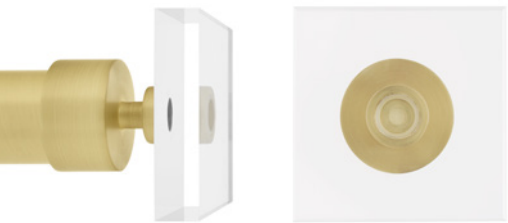

**TFCM692/CL** NEW  
**Eason Acrylic**  
 1"L x 2 7/8"W  
 pictured with  
 1 3/8" modern collar  
 and TFCM138 pole  
 in Satin Gold



**TFCM118690** NEW  
**Bex 1 1/8" End Cap**  
 3/4"L x 1 3/8"W  
 Satin Gold pictured with  
 TFCM118 pole

**TFCM138690** NEW  
**Bex 1 3/8" End Cap**  
 1"L x 1 5/8"W

*Bex End Caps do not require a cuff or collar.*

## cuffs & collars

Modern Collection finials are designed to coordinate with both 1 1/8" and 1 3/8" cuffs and collars. Please select a cuff or collar to match your selected pole diameter.



**TFCM118800** NEW  
 1 1/8" metal modern cuff  
 1"L x 1 3/8"W

**TFCM138800** NEW  
 1 3/8" metal modern cuff  
 1"L x 1 5/8"W



**TFCM118801** NEW  
 1 1/8" metal modern collar  
 1 5/8"L x 1 3/8"W

**TFCM138801** NEW  
 1 3/8" metal modern collar  
 1 5/8"L x 1 5/8"W



**TFCM118802** NEW  
 1 1/8" metal transitional collar  
 1 5/8"L x 1 3/8"W

**TFCM138802** NEW  
 1 3/8" metal transitional collar  
 1 7/8"L x 1 5/8"W

Finishes can be mixed and matched to create unique style combinations.



*Luca acrylic finial shown with 1 3/8" metal transitional collar in Satin Gold and TFCM138 acrylic pole.*

*Cuffs and collars are available in all modern finishes on page 9. Sold separately.*

# brackets

1 1/8" - 1 3/8"  
modern metal



TFCM118420 **NEW**  
1 1/8" metal bracket, single  
3 1/2" return, 2" Dia backplate

TFCM138420 **NEW**  
1 3/8" metal bracket, single  
3 1/2" return, 2 1/2" Dia backplate

TFCM118420L **NEW**  
1 1/8" metal bracket, single  
6" return, 2" Dia backplate

TFCM138420L **NEW**  
1 3/8" metal bracket, single  
6" return, 2 1/2" Dia backplate



TFCM118424 **NEW**  
1 1/8" metal bracket, double  
6 1/2" front and 3 1/2" back return,  
2" Dia backplate

TFCM138424 **NEW**  
1 3/8" metal bracket, double  
6 1/2" front and 3 1/2" back return,  
2 1/2" Dia backplate



TFCM118428 **NEW**  
1 1/8" bypass bracket, single  
3 1/2" return, 2" Dia backplate

TFCM138428 **NEW**  
1 3/8" bypass bracket, single  
3 1/2" return, 2 1/2" Dia backplate



TFCM118426 **NEW**  
1 1/8" eyelet bracket, single  
3 1/2" return, 2" Dia backplate

TFCM138426 **NEW**  
1 3/8" eyelet bracket, single  
3 1/2" return, 2 1/2" Dia backplate

TFCM118427 **NEW**  
1 1/8" eyelet bracket, single  
6" return, 2" Dia backplate

TFCM138427 **NEW**  
1 3/8" eyelet bracket, single  
6" return, 2 1/2" Dia backplate



TFCM118429 **NEW**  
1 1/8" eyelet bracket, double  
6" front and 3 1/2" back return,  
2" Dia backplate

TFCM138429 **NEW**  
1 3/8" eyelet bracket, double  
6" front and 3 1/2" back return,  
2 1/2" Dia backplate



TFCM118401 **NEW**  
1 1/8" inside mount brackets, 2pc  
1 3/4"W, 1 3/4" backplate, 1 1/4" deep,  
(sold in pairs)

TFCM138401 **NEW**  
1 3/8" inside mount brackets, 2pc  
2"W, 2" backplate, 1 3/8" deep,  
(sold in pairs)



TFCM118402 **NEW**  
1 1/8" hinged elbow  
1 3/4"L (1 1/2" each side when bent),  
1 1/8" base

TFCM138402 **NEW**  
1 3/8" hinged elbow  
2"L (1 3/4" each side when bent),  
1 3/8" base

Brackets shown in BBN Brushed Black Nickel.

# 1 1/8" - 1 3/8" modern metal

## poles

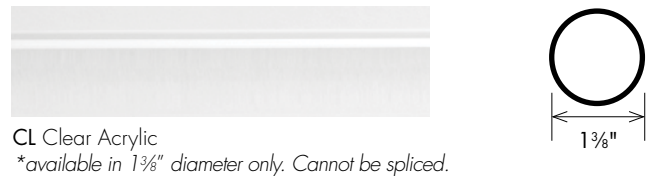

## pole lengths

### 1 1/8" diameter poles

- TFCM118002 - 2' **NEW**
- TFCM118004 - 4' **NEW**
- TFCM118006 - 6' **NEW**
- TFCM118008 - 8' **NEW**
- TFCM118010 - 10' **NEW**
- TFCM118012 - 12' **NEW**

### 1 3/8" diameter poles

- TFCM138002 - 2' **NEW**
- TFCM138004 - 4' **NEW**
- TFCM138006 - 6' **NEW**
- TFCM138008 - 8' **NEW**
- TFCM138010 - 10' **NEW**
- TFCM138012 - 12' **NEW**



Modern metal poles are sold in 2 foot increments, 2 foot minimum.  
Poles will be cut to specified length. Fall off will not be saved or shipped.

## rings



TFCM118205 **NEW**  
1 1/8" metal ring  
1 5/8"ID, 2 1/8"OD



TFCM118207 **NEW**  
1 1/8" metal c-ring  
1 5/8"ID, 2 1/8"OD

TFCM138205 **NEW**  
1 3/8" metal ring  
2"ID, 2 3/8"OD

TFCM138207 **NEW**  
1 3/8" metal c-ring  
2"ID, 2 3/8"OD

Rings include plastic inserts for smooth gliding and to prevent abrasion on poles. Rings shown in BBN Brushed Black Nickel.

## tiebacks



TFCM991 **NEW**  
metal tieback base  
2 1/2" projection, 2 3/8" Dia backplate



TFCM990 **NEW**  
metal tieback extension  
2"L

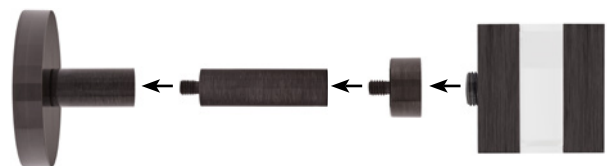

Can be used with any modern metal collection finial.

# accessories

1 1/8" - 1 3/8"  
modern metal



- A TFCM312S **NEW**  
metal baton  
3/8" Dia, available in 36"
- TFCM314S **NEW**  
metal baton  
3/8" Dia, available in 48"
- TFCM316S **NEW**  
metal baton  
3/8" Dia, available in 60"
- B ABTN-36 **NEW**  
clear acrylic baton  
5/8" Dia, available in 36"
- ABTN-48 **NEW**  
clear acrylic baton  
5/8" Dia, available in 48"

# finishes

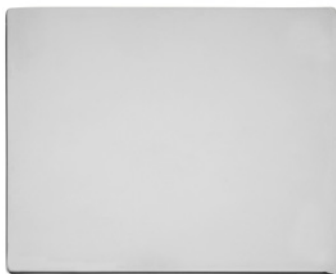

CH Chrome



BN Brushed Nickel



SG Satin Gold



BBN Brushed Black Nickel

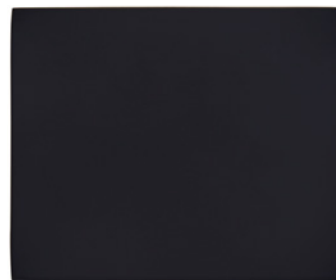

MK Matte Black



## 1<sup>3</sup>/<sub>8</sub>" metal collection

Inspired by a modern interpretation of classic and transitional silhouettes, our 1<sup>3</sup>/<sub>8</sub>" metal hardware collection blends unique custom quality design details with 8 beautifully layered plated finishes. For a unique finishing touch, you can now customize your metal hardware design by selecting from any of our 50 hand painted finishes.



**TFCM138100** **NEW**  
**Turner**  
5"L x 3"W  
Antique Pewter  
pictured with TFCM138 pole



**TFCM138101** **NEW**  
**Britton**  
3 1/4"L x 3 7/8"W  
Venetian Bronze  
pictured with TFCM138 pole  
in Matte Black



**TFCM138102** **NEW**  
**Ashby**  
3 7/8"L x 3 3/8"W  
Dark Oil Rubbed Bronze  
pictured with TFCM138 pole  
in Matte Black



**TFCM138103** **NEW**  
**Abington**  
4 3/8"L x 3 1/4"W  
Brushed Bronze  
pictured with TFCM138 pole



**TFCM138104** **NEW**  
**Harlow**  
4 3/8"L x 3"W  
Antique Brass  
pictured with TFCM138 pole



**TFCM138105** **NEW**  
**Weston**  
4 1/4"L x 3 1/8"W  
Polished Nickel  
pictured with TFCM138 pole



**TFCM138106** **NEW**  
**Brentford**  
3 5/8"L x 3 1/4"W  
Venetian Bronze  
pictured with TFCM138 pole  
in Matte Black



**TFCM138107** **NEW**  
**Rothwell**  
4 1/8"L x 3"W  
Oil Rubbed Bronze  
pictured with TFCM138 pole



**TFCM138190** **NEW**  
**Wells End Cap**  
1 1/4"L x 2 1/4"W  
Satin Black  
pictured with TFCM138 pole

## custom solutions: hand painted finishes

Our 1 3/8" metal collection is now available in any of our 50 beautifully hand painted finishes located on the back cover. Please see the Retail Price List for custom finish options and surcharges.



1 3/8"  
metal

## brackets



TFCM138400 **NEW**  
metal bracket, single  
3 1/2" - 4 1/2" return, 2" Dia backplate



TFCM138404 **NEW**  
metal bracket, double  
6" front and 3 1/2" back return,  
2" Dia backplate



TFCM138408 **NEW**  
bypass bracket, single  
3 1/2" - 4 1/2" return, 2" Dia backplate

TFCM138400L **NEW**  
metal bracket, single  
5" - 6 1/2" return, 2" Dia backplate



TFCM138406 **NEW**  
eyelet bracket, single  
3 1/2" return, 2" Dia backplate



TFCM138401 **NEW**  
1 3/8" inside mount brackets, 2pc  
2" W, 2" backplate, 1 3/8" deep,  
(sold in pairs)  
shown in MK Matte Black



TFCM138402 **NEW**  
1 3/8" hinged elbow  
2" L (1 3/4" each side when bent),  
1 3/8" base  
shown in MK Matte Black

Brackets shown in VZ Venetian Bronze.

## rings



TFCM138200 **NEW**  
metal ring  
2" ID, 2 3/8" OD



TFCM138201 **NEW**  
metal c-ring  
2" ID, 2 3/8" OD

Rings include plastic inserts for smooth gliding and to prevent abrasion on poles. MK rings coordinate with VZ and DRB finishes. Rings shown in MK Matte Black.

## tiebacks



TFCM138310 **NEW**  
1 5/8" projection, 1 3/8" Dia  
finial wall mount adaptor turns any finial into a tieback.  
use with any 1 3/8" metal collection finial.

Tieback shown in MK Matte Black with VZ Venetian Bronze finial.

# poles



PN Polished Nickel



AB Antique Brass

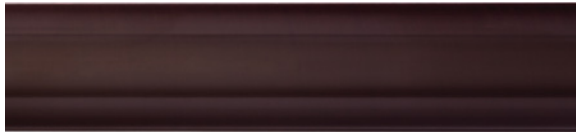

ORB Oil Rubbed Bronze

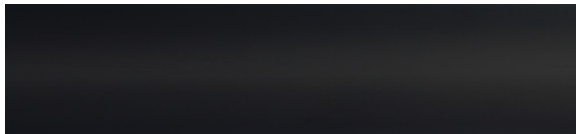

MK Matte Black coordinates with VZ Venetian Bronze & DRB Dark Oil Rubbed Bronze



AP Antique Pewter



BZ Brushed Bronze



SK Satin Black



SF Standard Finish - finish options available on the back cover.

## pole lengths

1 3/8" diameter poles

TFCM138202 - 2' **NEW**

TFCM138204 - 4' **NEW**

TFCM138206 - 6' **NEW**

TFCM138208 - 8' **NEW**

TFCM138210 - 10' **NEW**

TFCM138212 - 12' **NEW**



TFCM138403 **NEW**

1 3/8" pole splice

Continuous 10' & 12' poles not available in BZ or ORB finishes.

Metal poles are sold in 2 foot increments, 2 foot minimum. Poles will be cut to specified length. Fall off will not be saved or shipped.

## accessories



PN AP AB BZ ORB SK MK

A

B

A TFCM312S **NEW**  
metal baton  
3/8" Dia, available in 36"

TFCM314S **NEW**  
metal baton  
3/8" Dia, available in 48"

TFCM316S **NEW**  
metal baton  
3/8" Dia, available in 60"

B ABTN-36 **NEW**  
clear acrylic baton  
3/8" Dia, available in 36"

ABTN-48 **NEW**  
clear acrylic baton  
3/8" Dia, available in 48"



# finishes

Our 1<sup>3</sup>/<sub>8</sub>" metal collection is now available in any of our 50 beautifully hand painted finishes located on the back cover, as well as in the 8 plated finish options shown below. Please see the Retail Price List for custom finish options and surcharges.



PN Polished Nickel



AP Antique Pewter



AB Antique Brass



BZ Brushed Bronze



ORB Oil Rubbed Bronze



VZ Venetian Bronze



DRB Dark Oil Rubbed Bronze



SK Satin Black



1/2"

3/4"

1"

1 1/4"

1 1/2" - 1 3/4"

## steel

1/2" collection	15
3/4" collection	18
1" collection	25
1 1/4" collection	32
1 1/2" - 1 3/4" collection	39
outdoor hardware	45

actual pole sizes

1/2"

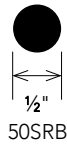
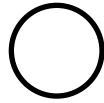

3/4"

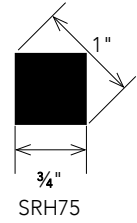
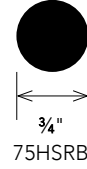
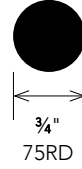
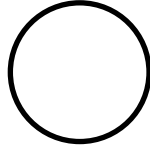

1"

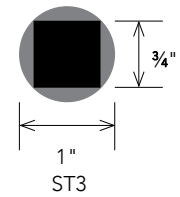
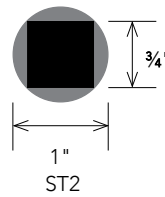
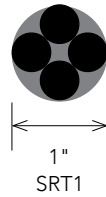
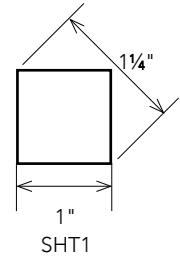
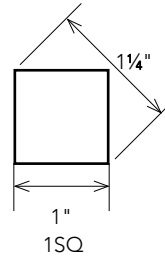
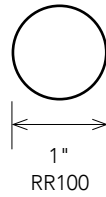
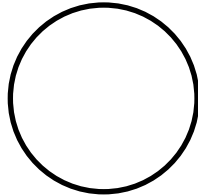

1 1/4"

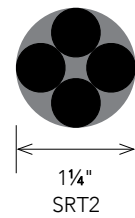
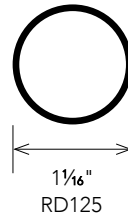
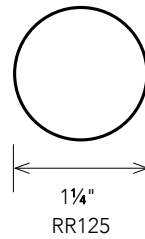
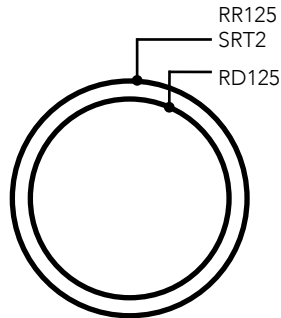

1 1/2" - 1 3/4"

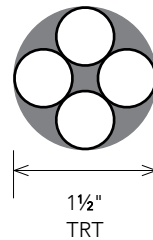
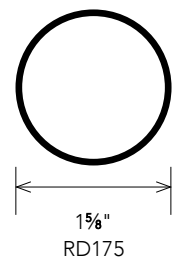
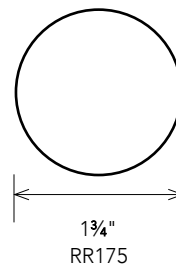
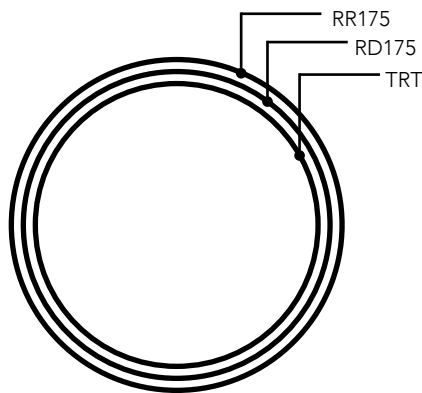



## 1/2" steel

The Finial Company's signature steel collection features cast and forged finials, brackets, poles and rings available in our 50 standard hand painted finishes; and has been updated to include an assortment of modern finial styles and design details that appeal to today's aesthetic. The 1/2" steel collection is ideal for French doors and smaller kitchen or bathroom windows designed to be covered with sheer to light weight window treatments.



**TFCS034110** NEW  
1 5/8"L x 1 5/8"W, 1" base  
860 Grayed Brass  
pictured with pole 50SRB



**F050-3**  
7/8"L x 1"W, 7/8" base  
630 Ash Gray  
pictured with pole 50SRB



**F050-1C**  
crystal finial  
1 1/2"L x 1 3/8"W, 7/8" base  
690 Champagne  
pictured with pole 50SRB,



**F050-1S**  
1 1/2"L x 1 3/8"W, 7/8" base  
660 Antique White  
pictured with pole 50SRB



**F050-2C**  
crystal finial  
1 5/8"L x 1 1/2"W (1 1/8"Sq), 7/8" base  
620 Weathered Iron  
pictured with pole 50SRB,



**SF37**  
1"L x 1"W  
600 Gilded Red  
pictured with pole 50SRB



**SF35**  
1"L x 1"W  
105 Bronze  
pictured with pole 50SRB



**S93**  
1 3/4"L x 1 1/4"W, 1" base  
320 Pewter  
pictured with pole 50SRB in  
109 Flat Black



**EC4**  
7/8"L x 1 1/4"W  
150 Gray with Gold  
pictured with pole 50SRB

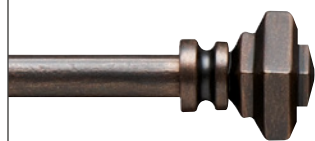

**F050-2S**  
1 5/8"L x 1 1/2"W (1 1/8"Sq), 7/8" base  
640 Oil Rubbed Bronze  
pictured with pole 50SRB

# brackets

## standard



**BKT050-1**  
adjustable steel bracket, single  
2½"-3½" return, ½"W x 2"L backplate



**BKT050-4** **NEW**  
steel bracket, single  
1" return, ½"W x 1¼"L backplate



**BKT050-3**  
steel bracket, single  
6" return, ½"W x 1¼"L backplate



**BKT050-2**  
steel bracket, double  
6" front and 3" back return,  
½"W x 2½"L backplate



**IMB050-1**  
½" steel inside mount brackets  
1"H x ¾"W backplate, ¾" Deep,  
⅛" thick backplate per bracket  
(sold in pairs)



**75ELB** **NEW**  
¾" hinged elbow  
2½"L, (1½"L each side when bent),  
⅞" base

Return distance is from wall to center of cradle.  
Standard brackets shown in 680 Aged Gold.

## custom solutions: brackets

Not seeing the bracket you need?

Check out our custom bracket and hardware solutions on page 56.

# rings



**SR05**  
smooth steel ring  
¾"D, 1½"OD

Ring shown in 680 Aged Gold.

# poles



**50SRB**  
steel pole, ½"Dia round solid pole  
maximum length is 240 inches



½" steel poles are sold in 1 foot increments, 2 foot minimum. Poles will be cut to specified length. Fall off will not be saved or shipped. Poles shown in 860 Grayed Brass.

# accessories



- A SBTN**  
steel baton, specify finish  
¾"Dia  
specify length up to 60"  
**SBTN60**  
specify length up to 96"
- B FBTN**  
fiberglass baton, white  
¾"Dia  
specify length up to 48"
- C ABTN-36** **NEW**  
clear acrylic baton  
¾"Dia, available in 36"  
**ABTN-48** **NEW**  
clear acrylic baton  
¾"Dia, available in 48"





## $\frac{3}{4}$ " steel

Our  $\frac{3}{4}$ " steel collection features finials in classic and traditional architectural shapes that can be hand painted for a custom design that reflects a range of home décor styles. Our ability to customize nearly any steel item guarantees that you can create a unique design for your window treatment.



**TFC034110** NEW  
1 5/8" L x 1 5/8" W, 1" base  
810 Bronzed Ore  
pictured with pole 75RD



**SEC-125** OH  
1/4" L x 1 1/3" W, 1 1/3" base  
680 Aged Gold  
pictured with pole 75RD



**EC4**  
7/8" L x 1 1/4" W  
150 Gray with Gold  
pictured with pole 75RD



**SF36**  
1 1/4" L x 1 1/4" W  
105 Bronze  
pictured with pole 75RD



**S93**  
1 3/4" L x 1 1/4" W, 1" base  
320 Pewter  
pictured with pole 75HSRB



**SF202A**  
1 5/8" L x 1 5/8" W  
750 Polished Gold  
pictured with pole 75RD



**SF202B**  
2" L x 2" W  
640 Oil Rubbed Bronze  
pictured with pole 75HSRB



**SF3**  
2 1/4" L x 1 5/8" W, 1 1/4" base  
129 Antique Steel  
pictured with pole 75RD



**SF180**  
3 7/8" L x 2" W, 1 3/4" base  
710 Tarnished Silver  
pictured with pole 75RD



**SF-1**  
3 3/8" L x 2 3/8" W, 1 5/8" base  
610 Cobalt Bronze  
pictured with pole 75HSRB



**SF69**  
3 1/2" L x 2 1/2" W, 1 3/4" base  
620 Weathered Iron  
pictured with pole 75HSRB



**SF133**  
2" L x 2 3/8" W, 1 1/4" sq base  
690 Champagne  
pictured with pole SRH75



**L651**  
5 1/8" L x 3 7/8" W, 1" base  
110 Flat Black with Gold  
pictured with pole 75RD



**SF201**  
2 3/4" L x 1 5/8" W, 1 1/4" sq base  
630 Ash Gray  
pictured with pole SRH75

## custom solutions: did you know?



Our custom solutions shop can add a rosette to the front of any bracket. For more ideas on how to customize your steel brackets, turn to page 57 in Custom Solutions.



Did you know we can add a bent return to your 3/4" solid 75RD and 75HSRB poles? To find out more about bends and miters for all poles, turn to page 50 in Custom Solutions.

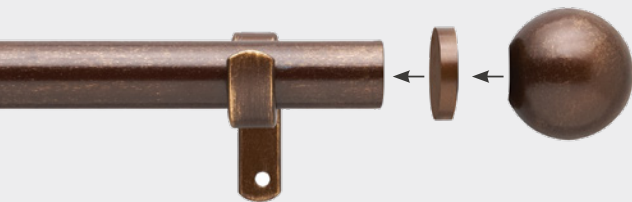

Do you wish your 3/4" finial could fit a larger pole diameter? It can with the addition of a finial adaptor. See page 58 for more options.



**SF135**  
2"L x 2"W, 1 3/8" base  
250 Platinum  
pictured with pole  
75RD

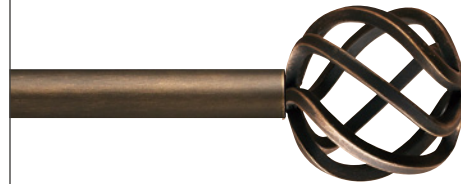

**SF158B7**  
3"L x 2 3/4"W  
106 Bronze with Gold  
pictured with pole  
75RD

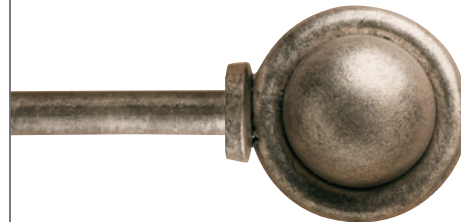

**SF236**  
3 1/4"L x 3"W, 1 3/8"  
base  
250B Platinum with  
Black Highlights  
pictured with pole  
75RD



**K657**  
4"L x 2"W, 1 3/4" base  
110 Flat Black with Gold  
pictured with pole  
75RD



**L885875**  
5 3/4"L x 3 3/4"W, 1 1/2" base  
107 Bronze with Gold  
and Gray  
pictured with pole  
SRH75



**Branch with Leaf**  
14"L x 10"W  
please specify right (shown) or left  
270 Mahogany Rust with  
custom green on leaves  
pictured with pole 75RD

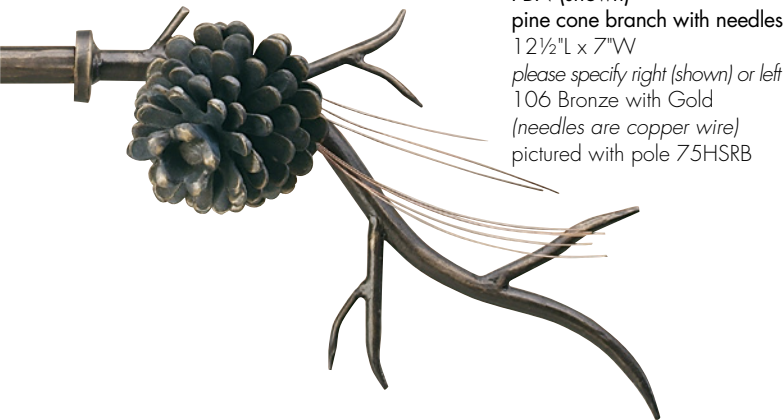

**PBN (shown)**  
pine cone branch with needles  
12 1/2"L x 7"W  
please specify right (shown) or left  
106 Bronze with Gold  
(needles are copper wire)  
pictured with pole 75HSRB

**PB (not shown)**  
pine cone branch (no needles)  
12 1/2"L x 7"W  
please specify right or left



**BIRD**  
single bird on branch  
14"L x 11 1/2"W  
please specify right (shown) or left  
270 Mahogany Rust with  
custom green on leaves  
pictured with pole 75RD



**L848** OH  
7 1/2"L x 4 1/4"W, 1" base  
110 Flat Black with Gold  
pictured with pole 75RD



**SF19**  
3 1/2"L x 6 3/4"W, 1 3/8" base  
680 Aged Gold  
pictured with pole 75RD

# brackets

## standard



**BKT075-100**  
adjustable steel bracket, single  
3½"-5" return, 1"W x 3"L backplate



**L125100**  
steel bracket, single  
2" return, ¾"W x 2½"L backplate



**TFCS100LASBK** **NEW**  
steel bracket, single  
3½" return, ¾"W x 3¾"L backplate



**TFCS100LADBK** **NEW**  
steel bracket, double  
6" front and 3" back return,  
¾"W x 3¾"L backplate

**L135100**  
steel bracket, single  
3⅝" return, ¾"W x 2½"L backplate

**TFCS100LAS6BK** **NEW**  
steel bracket, single  
6" return, ¾"W x 3¾"L backplate



**EB1**  
steel eyelet bracket, single  
3½" return, 1"W x 3½"L  
backplate, eyelet 1"ID



**L125-SQ**  
steel square bracket, single  
2½" return, ¾"W x 2½"L backplate



**TFCS100MCMBK** **NEW**  
1" steel ceiling mount bracket  
2" Dia ceiling plate, 2¼"H  
2⅛" drop (distance from ceiling  
to bottom of pole)



**TFCS100MIBK** **NEW**  
1" steel inside mount brackets  
1⅞"H x 1⅜"W backplate, ¾" Deep,  
⅛" thick backplate per bracket  
(sold in pairs)

**EB2**  
steel eyelet bracket, single  
6" return, 1"W x 3½"L  
backplate, eyelet 1"ID

**L135-SQ**  
steel square bracket, single  
3½" return, ¾"W x 2½"L backplate  
*note: square brackets above are to be  
used with SRH75 square pole*



**75ELB** **NEW**  
¾" hinged elbow  
2½"L, (1⅜"L each side when bent),  
⅞" base

*Return distance is from wall to center of cradle.  
Standard brackets shown in 680 Aged Gold.*

## custom solutions: bypass brackets

**CAUTION:** Bypass Brackets do not have full cradles. Standard brackets must be installed at each end to secure ¾" pole.

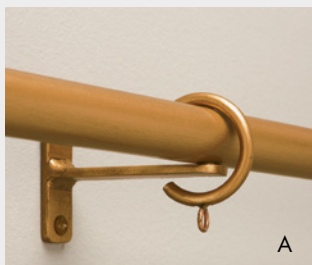

A



D

**A. SCB35**  
steel custom bypass bracket, single  
3½" return, ¾"W backplate x 2½"  
or 3"L

**B. SCB6**  
steel custom bypass bracket, single  
6" return, ¾"W backplate x 2½"  
or 3"L

**C. SCBC**  
steel custom bypass bracket, single  
custom return, ¾"W backplate  
x 2½" or 3"L

**D. SCBCDBL**  
steel custom bypass bracket, double  
custom return, ¾"W backplate  
x 5¼"L

Use with 75RD pole and CR-SR75 c-ring. For more bypass bracket information, see page 56.

## custom solutions: brackets

The Finial Company is known for quality craftsmanship and can create custom brackets to match your job specifications. We can customize bracket dimensions, returns and finish on any pole for a custom fit on every job. For more custom solutions products see our custom brackets section on page 56.



**TBKT**  
custom steel t-bracket, single  
please specify:  
A. return (distance from wall to center of cradle)  
B. pole size and profile  
note: 3½"H backplate comes standard, unless otherwise specified



**DBL1**  
custom steel bracket, double  
please specify:  
A. front pole size and profile  
B. back pole size and profile  
C. rings to be used, if any  
D. front and back returns (distance from wall to center of cradle)  
note: returns are contingent upon which poles and rings are chosen  
3½"H backplate comes standard, unless otherwise specified



**BL4**  
custom steel ceiling mount bracket  
please specify:  
A. drop (distance from ceiling to top of pole)  
B. pole size and profile  
C. rings to be used, if any  
note: minimum drop is contingent upon which finial and ring are chosen.  
2½"W backplate comes standard, unless otherwise specified



**FBKT**  
custom steel bracket, single  
please specify:  
A. return (distance from wall to center of cradle)  
B. pole size and profile  
note: 4¾"H backplate may not be modified

Return or drop distance in excess of 8" on any custom bracket will incur additional fees and requires addition of support arm. Custom brackets are shown unfinished, but will be hand painted in your selected Standard Finish (see back cover) or for a custom finish you can send us a finish sample and we'll prepare a strike-off sample for approval (see Retail Price List for custom finish charges).

## rings



**SR1**  
smooth steel ring  
1"ID, 1½"OD



**SQRG1**  
smooth square steel ring  
1½"ID, 2½"OD



**CR-SR75** NEW  
smooth steel c-ring  
1¼"ID, 1¾"OD  
use with 75RD pole and SCB35, SCB6, SCBC or SCBCDBL bypass brackets

3/4"  
steel

## custom solutions: french returns

Our custom metal shop can create custom bent and mitered pole returns for any window. For more details, see pages 50–53 in the Custom Solutions section.



## poles



**75RD**  
3/4" Dia solid steel pole, round  
maximum length is 220 inches

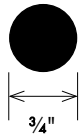

**75HSRB**  
3/4" Dia hammered solid steel pole, round  
maximum length is 115 inches

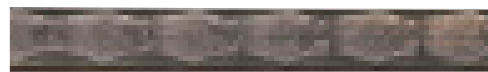
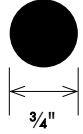

**SRH75**  
3/4" Sq hammered solid steel pole, square  
maximum length is 228 inches

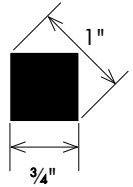

3/4" steel poles are sold in 1 foot increments, 2 foot minimum. Poles will be cut to specified length. Fall off will not be saved or shipped. Poles shown in 860 Grayed Brass.

## accessories



- A SBTN**  
steel baton, specify finish  
3/8" Dia  
specify length up to 60"  
**SBTN60**  
specify length up to 96"
- B FBTN**  
fiberglass baton, white  
3/8" Dia  
specify length up to 48"
- C ABTN-36** **NEW**  
clear acrylic baton  
3/8" Dia, available in 36"  
**ABTN-48** **NEW**  
clear acrylic baton  
3/8" Dia, available in 48"



## 1" steel

Our most popular diameter in the steel category, the 1" steel collection features the largest selection of quality crafted finial designs and pole styles including round, square, hammered and twisted options to create the perfect window hardware solution for a well-designed room. The six new finial designs feature cleaner profiles and glass options to reflect a more modern aesthetic.



# 1" steel



**TFCS114111** **NEW**  
1¾"L x 1⅞"W, 1⅝" sq base  
850 Soft Brass  
pictured with pole 1SQ



**TFCS114120** **NEW**  
1⅞"L x 2¼"W, 1¾" base  
860 Grayed Brass  
pictured with pole ST2



**TFCS114190** **NEW**  
1⅞"L x 2¼"W, 1⅝" base  
830 Driftwood  
pictured with pole RR100



**TFCS114110** **NEW**  
1⅞"L x 2⅜"W, 1⅝" base  
820 Sea Salt Black  
pictured with pole 1SQ



**TFCS114170** **NEW**  
glass finial  
2⅞"L x 2⅜"W, 1⅝" base  
810 Bronzed Ore  
pictured with pole RR100



**TFCS114171** **NEW**  
glass finial  
3⅞"L x 2⅞"W, 1⅝" base  
800 Charred Toasted Oak  
pictured with pole RR100



**SEC-125** **OH**  
¼"L x 1⅓"W, 1⅓" base  
105 Bronze  
pictured with pole RR100  
*not for use with square pole  
1SQ or SHT1*



**SF201**  
2¾"L x 1⅞"W, 1¼" sq base  
630 Ash Gray  
pictured with pole SHT1



**SQEC**  
¼"L x 1⅞"W, 1⅞" sq base  
109 Flat Black  
pictured with pole 1SQ  
*finial only fits 1SQ &  
SHT1 poles*



**SF230**  
2¼"L x 2"W, 1⅞" base  
700 Graphite  
pictured with pole ST3



**SF202A**  
1⅝"L x 1⅞"W  
150 Gray with Gold  
pictured with pole RR100



**SF202B**  
2"L x 2"W  
640 Oil Rubbed Bronze  
pictured with pole RR100



**EC135** **OH**  
1¼"L x 2⅞"W, 2" base  
110 Flat Black with Gold  
pictured with pole RR100



**SF180**  
3⅞"L x 2"W, 1¾" base  
730 Rose Gold  
pictured with pole SRT1



**SF237**  
2⅞"L x 1⅞"W, 1⅞" base  
100 Polished Steel  
pictured with pole ST3

*\*please note: there is an  
upcharge for this custom  
finish; please refer to Retail  
Price List for details.*



**SF69**  
3½"L x 2½"W, 1¾" base  
330 Bronze with Black  
pictured with pole SRT1



**SF133**  
2"L x 2<sup>3</sup>/<sub>8</sub>"W, 1<sup>1</sup>/<sub>4</sub>" sq base  
680 Aged Gold  
pictured with pole 1SQ



**L9328**  
2"L x 2"W  
106 Bronze with Gold  
pictured with pole RR100



**L9328B**  
2<sup>3</sup>/<sub>4</sub>"L x 2"W, 1<sup>3</sup>/<sub>8</sub>" base  
117 Walnut Gold  
pictured with pole RR100

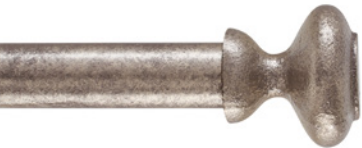

**SF135**  
2"L x 2"W, 1<sup>3</sup>/<sub>8</sub>" base  
250 Platinum  
pictured with pole RR100



**K657**  
4"L x 2"W, 1<sup>3</sup>/<sub>4</sub>" base  
110 Flat Black with Gold  
pictured with pole RR100



**SF45**  
3"L x 2<sup>1</sup>/<sub>2</sub>"W, 1<sup>5</sup>/<sub>8</sub>" base  
110 Flat Black with Gold  
pictured with pole RR100



**SF236**  
3<sup>1</sup>/<sub>4</sub>"L x 3"W, 1<sup>5</sup>/<sub>8</sub>" base  
250B Platinum with Black  
pictured with pole RR100

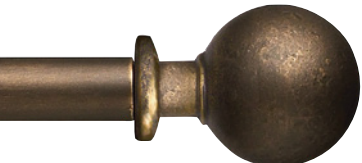

**4519C** OH  
3<sup>1</sup>/<sub>2</sub>"L x 2<sup>3</sup>/<sub>4</sub>"W, 1<sup>3</sup>/<sub>4</sub>" base  
106 Bronze with Gold  
pictured with pole RR100



**SF-1**  
3<sup>3</sup>/<sub>8</sub>"L x 2<sup>3</sup>/<sub>8</sub>"W, 1<sup>5</sup>/<sub>8</sub>" base  
126 Dark Walnut Gloss  
with Gold  
pictured with pole ST3



**SF158B7**  
3"L x 2<sup>3</sup>/<sub>4</sub>"W  
106 Bronze with Gold  
pictured with pole ST3



**L885875**  
5<sup>3</sup>/<sub>4</sub>"L x 3<sup>3</sup>/<sub>4</sub>"W, 1<sup>1</sup>/<sub>2</sub>" sq base  
107 Bronze with Gold and  
Gray pictured with pole SHT1



**L651**  
5<sup>1</sup>/<sub>8</sub>"L x 3<sup>7</sup>/<sub>8</sub>"W, 1" base  
110 Flat Black with Gold  
pictured with pole RR100



**L848** OH  
7<sup>1</sup>/<sub>2</sub>"L x 4<sup>1</sup>/<sub>4</sub>"W, 1" base  
110 Flat Black with Gold  
pictured with pole RR100



**SF132**  
4<sup>1</sup>/<sub>4</sub>"L x 4<sup>3</sup>/<sub>4</sub>"W, 2" base  
350G Statuary Bronze  
with Gold  
pictured with pole RR100

1"  
steel



**Branch with Leaf**  
14"L x 10"W  
*please specify right (shown) or left*  
270 Mahogany Rust with  
custom green on leaves  
pictured with pole 75RD

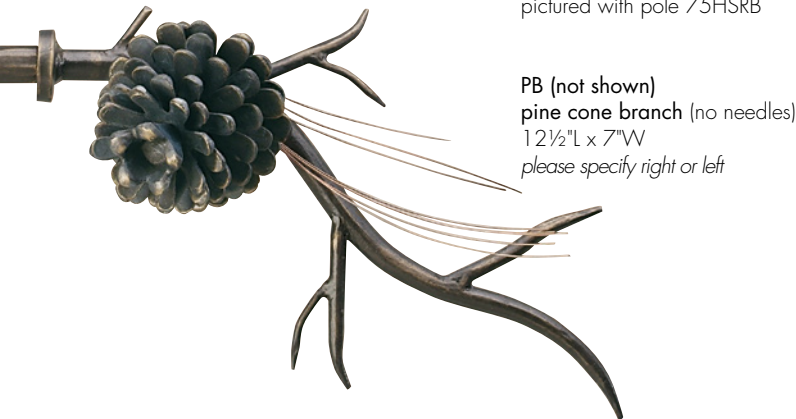

**PBN (shown)**  
pine cone branch with needles  
12½"L x 7"W  
*please specify right (shown) or left*  
106 Bronze with Gold  
(needles are copper wire)  
pictured with pole 75HSRB



**PB (not shown)**  
pine cone branch (no needles)  
12½"L x 7"W  
*please specify right or left*



**BIRD**  
single bird on branch  
14"L x 11½"W  
*please specify right (shown) or left*  
270 Mahogany Rust with  
custom green on leaves  
pictured with pole 75RD



**SF19**  
3½"L x 6¾"W, 1⅜" base  
680 Aged Gold  
pictured with pole 75RD

# brackets

1"  
steel

## standard



**BKT075-100**  
adjustable steel bracket, single  
3½"-5" return, 1"W x 3"L backplate



**L125100**  
steel bracket, single  
2" return, ¾"W x 2½"L backplate



**TFCS100LASBK** **NEW**  
steel bracket, single  
3½" return, ¾"W x 3¾"L backplate



**TFCS100LADBK** **NEW**  
steel bracket, double  
6" front and 3" back return,  
¾"W x 3¾"L backplate

**L135100**

steel bracket, single  
3¾" return, ¾"W x 2½"L backplate

**TFCS100LAS6BK** **NEW**

steel bracket, single  
6" return, ¾"W x 3¾"L backplate



**TFCS100GRSBK** **NEW**  
steel bypass bracket, single  
3½" return, ¾"W x 3¾"L  
backplate  
use with RR100 pole and  
TFCS100SCR1 c-ring



**TFCS100GRDBK** **NEW**  
steel bypass bracket, double  
6" front and 3" back return,  
¾"W x 3¾"L backplate  
use with RR100 pole and  
TFCS100SCR1 c-ring



**L125-SQ**  
steel square bracket, single  
2½" return, ¾"W x 2½"L backplate



**TFCS100MCMBK** **NEW**  
1" steel ceiling mount bracket  
2" Dia ceiling plate, 2¼"H,  
2⅞" drop (distance from ceiling  
to bottom of pole)

**L135-SQ**

steel square bracket, single  
3½" return, ¾"W x 2½"L backplate

*(note: square brackets above are to be  
used with 1SQ and SHT1 square poles)*



**TFCS100MBK** **NEW**  
1" steel inside mount brackets  
1⅞"H x 1⅜"W backplate, ¾"Deep,  
⅝" thick backplate per bracket  
(sold in pairs)



**TFCR100REL** **NEW**  
1" hinged elbow  
3¼"L, (2⅞"L each side when bent),  
1⅞" base

*Return distance is from wall to center of cradle.  
Standard brackets shown in 680 Aged Gold.*

## custom solutions: bypass brackets

**CAUTION:** Bypass Brackets do not have full cradles. Standard brackets must be installed at each end to secure 1" pole.

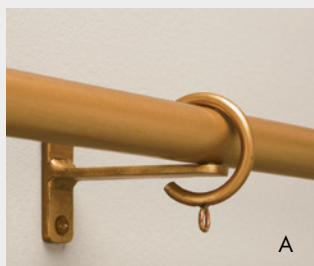

A

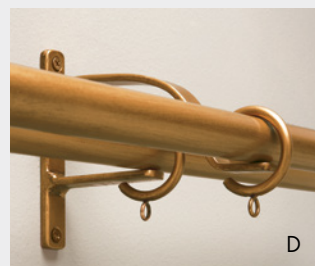

D

**A. SCB35**  
steel custom bypass bracket, single  
3½" return, ¾"W backplate  
x 2½" or 3"L

**B. SCB6**  
steel custom bypass bracket, single  
6" return, ¾"W backplate  
x 2½" or 3"L

**C. SCBC**  
steel custom bypass bracket, single  
custom return, ¾"W backplate  
x 2½" or 3"L

**D. SCBCDBL**  
steel custom bypass bracket, double  
custom return, ¾"W backplate  
x 5¼"L

Use with RR100 pole and CR-SR3 c-ring. For more bypass bracket  
information, see page 56.

## custom solutions: brackets

The Finial Company is known for quality craftsmanship and can create custom brackets to match your job specifications. We can customize bracket dimensions, returns and finish on any pole for a custom fit on every job. For more custom solutions products see our custom brackets section on page 56.



**TBKT**  
custom steel t-bracket, single  
please specify:  
A. return (distance from wall to center of cradle)  
B. pole size and profile  
note: 3½"H backplate comes standard, unless otherwise specified



**DBL1**  
custom steel bracket, double  
please specify:  
A. front pole size and profile  
B. back pole size and profile  
C. rings to be used, if any  
D. front and back returns (distance from wall to center of cradle)  
note: returns are contingent upon which poles and rings are chosen  
3½"H backplate comes standard, unless otherwise specified



**BL4**  
custom steel ceiling mount bracket  
please specify:  
A. drop (distance from ceiling to top of pole)  
B. pole size and profile  
C. rings to be used, if any  
note: minimum drop is contingent upon which finial and ring are chosen.  
2½"W backplate comes standard, unless otherwise specified



**FBKT**  
custom steel bracket, single  
please specify:  
A. return (distance from wall to center of cradle)  
B. pole size and profile  
note: 4¾"H backplate may not be modified

Return or drop distance in excess of 8" on any custom bracket will incur additional fees and requires addition of support arm. Custom brackets are shown unfinished, but will be hand painted in your selected Standard Finish (see back cover) or for a custom finish you can send us a finish sample and we'll prepare a strike-off sample for approval (see Retail Price List for custom finish charges).

## rings



**SR3**  
smooth steel ring  
1½"ID, 2"OD



**FSR1**  
smooth heavy steel ring  
1¾"ID, 2¾"OD



**SQRG1**  
smooth square steel ring  
1½"ID, 2½"OD



**CR-SR3**  
smooth steel c-ring  
1½"ID x 2"OD  
use with RR100 pole and SCB35, SCB6, SCBC or SCBCDBL bypass brackets



**TFCS100SCRI** NEW  
smooth steel c-ring  
1½"ID, 2"OD  
use with RR100 pole and TFCS100GRSBK or TFCS100GRDBK bypass brackets

Rings shown in 680 Aged Gold.

# poles

1"  
steel



**RR100**  
1" round tube  
maximum length is 192 inches

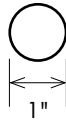

**1SQ**  
1" smooth square tube  
maximum length is 288 inches; use with L125-SQ,  
L135-SQ brackets, SQRG1 ring

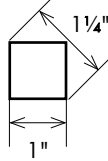

**SHT1**  
1" square hammered tube  
maximum length is 228 inches; use with L125-SQ,  
L135-SQ brackets, SQRG1 ring

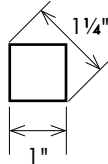

**SRT1**  
1" solid rope twist pole  
maximum length is 228 inches; use ring with minimum  
1 1/2" ID

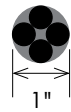

**ST2**  
1" single twist solid steel pole  
maximum length is 228 inches; use ring with minimum  
1 1/2" ID

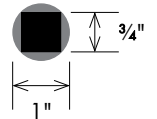

**ST3**  
1" double twist solid steel pole  
maximum length is 228 inches; use ring with minimum  
1 1/2" ID

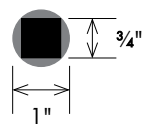

1" steel poles are sold in 1 foot increments, 2 foot minimum. Poles will be cut to specified length. Fall off will not be saved or shipped.  
**note:** twisted poles can appear uneven. Poles shown in 860 Grayed Brass.

## custom solutions: french returns

Our custom metal shop can create custom bent and mitered pole returns for any window. For more details, see pages 50 – 53 in the Custom Solutions section.



## accessories



A B C

- A SBTN**  
steel baton, specify finish  
3/8" Dia  
specify length up to 60"  
**SBTN60**  
specify length up to 96"
- B FBTN**  
fiberglass baton, white  
3/8" Dia  
specify length up to 48"
- C ABTN-36** NEW  
clear acrylic baton  
3/8" Dia, available in 36"  
**ABTN-48** NEW  
clear acrylic baton  
3/8" Dia, available in 48"



**MB100**  
metal band, attaches any rosette to front  
of 1" Dia pole  
use with 1" pole only  
for more information on metal bands,  
see page 92 .



MB100 with EC3 rosette on  
RR100 pole, finish 620  
Weathered Iron



## 1 $\frac{1}{4}$ " steel

The 1 $\frac{1}{4}$ " steel collection features 30 finial designs in cast and forged styles for the perfect custom crafted detail. Classic shapes, architectural details and six new finial designs offer an updated appeal to this collection.



**TFCS114111** **NEW**  
1 3/4"L x 1 7/8"W, 1 5/8" sq base  
830 Driftwood  
pictured with pole RD125



**TFCS114120** **NEW**  
1 7/8"L x 2 1/8"W, 1 3/4" base  
880 Parchment  
pictured with pole RD125



**TFCS114190** **NEW**  
1 7/8"L x 2 1/4"W, 1 5/8" base  
870 Chalet Gray  
pictured with pole RR125



**TFCS114110** **NEW**  
1 7/8"L x 1 3/8"W, 1 5/8" base  
820 Sea Salt Black  
pictured with pole RD125



**TFCS114170** **NEW**  
glass finial  
2 7/8"L x 2 3/8"W, 1 5/8" base  
810 Bronzed Ore  
pictured with pole RD125



**TFCS114171** **NEW**  
glass finial  
3 7/8"L x 2 1/8"W, 1 5/8" base  
800 Charred Toasted Oak  
pictured with pole RR125



**RF4**  
1"L x 1 7/8"W  
110 Flat Black with Gold  
pictured with pole RR125



**EC135** **OH**  
1 1/4"L x 2 1/8"W, 2" base  
110 Flat Black with Gold  
pictured with pole RR125



**SEC-125** **OH**  
1/4"L x 1 1/3"W, 1 1/3" base  
105 Bronze  
pictured with pole RR125



**SEC-2** **OH**  
1/4"L x 2"W, 2" base  
106 Bronze with Gold  
pictured with pole SRT2



1 1/4"  
steel



**SF133**  
2"L x 2 3/8"W, 1 1/4" sq base  
770 Bronze Patina  
pictured with pole RR125



**SF230**  
2 1/4"L x 2"W, 1 7/8" base  
610 Cobalt Bronze  
pictured with pole RR125



**SF237**  
2 1/8"L x 1 5/8"W, 1 7/8" base  
330 Bronze with Black  
pictured with pole RR125



**SF-4**  
3 1/3"L x 2 1/2"W, 2" base  
110 Flat Black with Gold  
pictured with pole RR125



**SF63** **OH**  
2 1/2"L x 2 1/2"W, 2" base  
129 Antique Steel  
pictured with pole RR125



**L9328**  
2"L x 2"W  
106 Bronze with Gold  
pictured with pole RR125



**SF131**  
4"L x 2 1/4"W, 2" base  
110 Flat Black with Gold  
pictured with pole RR125



**SSA**  
4"L x 3 1/8"W, 2" base  
106 Bronze with Gold  
pictured with pole SRT2



**SF45**  
3"L x 2 1/2"W, 1 5/8" base  
110 Flat Black with Gold  
pictured with pole RR125



**4519C** **OH**  
3 1/2"L x 2 3/4"W, 2" base  
106 Bronze with Gold  
pictured with pole RR125

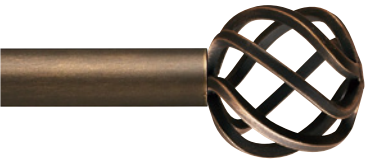

**SF158B7**  
3"L x 2 3/4"W  
106 Bronze with Gold  
pictured with pole RR125



**14R704**  
3 3/8"L x 2"W, 2" base  
107 Bronze with Gold  
and Gray  
pictured with pole SRT2



**K657**  
4"L x 2"W, 1 3/4" base  
110 Flat Black with Gold  
pictured with pole RR125



**SF138**  
4"L x 2 1/4"W, 2" base  
350G Statuary Bronze  
with Gold  
pictured with pole SRT2



**SF132**  
4 1/4"L x 4 3/4"W, 2" base  
350G Statuary Bronze with Gold  
pictured with pole RR125



**LS385** OH  
5"L x 4 1/2"W  
250B Platinum with  
Black Highlights  
pictured with pole SRT2

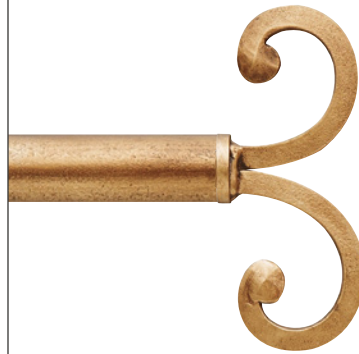

**SF19**  
3 1/2"L x 6 3/4"W, 1 3/8" base  
680 Aged Gold  
pictured with pole RR125



**SF70**  
5 1/4"L x 3"W, 2" base  
270 Mahogany Rust  
pictured with pole RR125



**SF96**  
4 1/4"L x 7"W, 2" base  
250 Platinum  
pictured with pole SRT2

# brackets

## standard



**BKT118-138**  
adjustable steel bracket, single  
3 3/8" return, 1"W x 3 1/4"L  
backplate



**L125**  
steel bracket, single  
2 1/2" return, 3/4"W x 2"L backplate



**L235**  
steel bracket, single  
3 1/2" return, 3/4"W x 3 3/8"L backplate



**CSL125**  
steel bracket, single  
2 3/8" return, 2 1/2"W x 1 1/2"L backplate

**L135**  
steel bracket, single  
3 3/8" return, 3/4"W x 2 1/2"L backplate

**L26**  
steel bracket, single  
6" return, 3/4"W x 3 3/8"L backplate

**CSL135**  
steel bracket, single  
3 3/8" return, 2 1/2"W x 1 1/2"L backplate

**L16**  
steel bracket, single  
6" return, 3/4"W x 2 1/2"L backplate

**CSL16**  
steel bracket, single  
6" return, 2 1/2"W x 1 1/2"L backplate



**TFCS114GRSBK** **NEW**  
steel bypass bracket, single  
3 1/2" return, 3/4"W x 3 3/4"L  
backplate  
Use with RR125 pole and  
TFCS114MCRI c-ring.



**TFCS114GRDBK** **NEW**  
steel bypass bracket, double  
6" front and 3" back return,  
3/4"W x 3 3/4"L backplate  
Use with RR125 pole and  
TFCS114MCRI c-ring.



**EB3**  
steel eyelet bracket, single  
3 1/2" return, 1"W x 3 1/2"L backplate  
eyelet 1 3/8"ID



**TFCS114MCMBK** **NEW**  
1 1/4" steel ceiling mount bracket  
2" Dia ceiling plate, 2 3/4"H, 2 3/8"  
drop (distance from ceiling to  
bottom of pole)

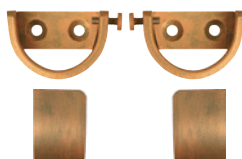

**IM125**  
1 1/4" steel inside mount brackets  
1 1/8"H x 1 3/8"W backplate, 3/4" Deep,  
1/8" thick backplate per bracket  
(sold in pairs)



**TFCR114REL** **NEW**  
1 1/4" hinged elbow  
3 3/8"L, (2 1/2"L each side when bent),  
1 3/8" base

**EB4**  
steel eyelet bracket, single  
6" return, 1"W x 3 1/2"L backplate  
eyelet 1 3/8"ID

*Return distance is from wall to center of cradle.  
Standard brackets shown in 680 Aged Gold.*

## custom solutions: bypass brackets

**CAUTION:** Bypass Brackets do not have full cradles. Standard brackets must be installed at each end to secure 1 1/4" pole.

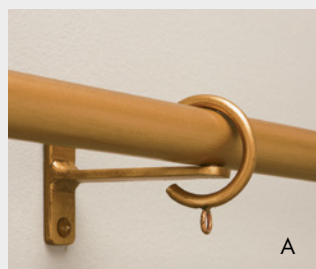

A



D

**A. SCB35**  
steel custom bypass bracket, single  
3 1/2" return, 3/4"W backplate  
x 2 1/2" or 3"L

**B. SCB6**  
steel custom bypass bracket, single  
6" return, 3/4"W backplate  
x 2 1/2" or 3"L

**C. SCBC**  
steel custom bypass bracket, single  
custom return, 3/4"W backplate  
x 2 1/2" or 3"L

**D. SCBCDBL**  
steel custom bypass bracket, double  
custom return, 3/4"W backplate  
x 5 1/4"L

Use with RD125 and RR125 poles and CR-SR7 c-ring. For more  
bypass bracket information, see page 56.

## custom solutions: brackets

The Finial Company is known for quality craftsmanship and can create custom brackets to match your job specifications. We can customize bracket dimensions, returns and finish on any pole for a custom fit on every job. For more custom solutions products see our custom brackets section on page 56.



**TBKT**  
custom steel t-bracket, single  
please specify:  
A. return (distance from wall to center of cradle)  
B. pole size and profile  
note: 3 1/2"H backplate comes standard, unless otherwise specified



**DBL1**  
custom steel bracket, double  
please specify:  
A. front pole size and profile  
B. back pole size and profile  
C. rings to be used, if any  
D. front and back returns (distance from wall to center of cradle)  
note: returns are contingent upon which poles and rings are chosen  
3 1/2"H backplate comes standard, unless otherwise specified



**BL4**  
custom steel ceiling mount bracket  
please specify:  
A. drop (distance from ceiling to top of pole)  
B. pole size and profile  
C. rings to be used, if any  
note: minimum drop is contingent upon which finial and ring are chosen.  
2 1/2"W backplate comes standard, unless otherwise specified



**FBKT**  
custom steel bracket, single  
please specify:  
A. return (distance from wall to center of cradle)  
B. pole size and profile  
note: 4 3/4"H backplate may not be modified

Return or drop distance in excess of 8" on any custom bracket will incur additional fees and requires addition of support arm. Custom brackets are shown unfinished, but will be hand painted in your selected Standard Finish (see back cover) or for a custom finish you can send us a finish sample and we'll prepare a strike-off sample for approval (see Retail Price List for custom finish charges).

## rings



**SR3**  
smooth steel ring  
1 1/2"ID, 2"OD



**FSR1**  
smooth heavy steel ring  
1 3/4"ID, 2 3/4"OD



**HSR1**  
hammered steel ring  
1 3/4"ID, 2 1/2"OD



**OVL3**  
smooth oval steel ring  
1 1/2"ID, 2"OD, 2 1/2"L



**CR-SR3**  
smooth steel c-ring  
1 1/2"ID x 2"OD  
use with RD125 pole and SCB35, SCB6, SCBC or SCBCDBL bypass brackets



**CR-SR7**  
smooth steel c-ring  
2 1/4"ID, 2 3/4"OD  
use with RR125 pole and SCB35, SCB6, SCBC or SCBCDBL bypass brackets



**TFCS114MCRI** NEW  
smooth steel c-ring  
2"ID, 2 1/2"OD  
use with RR125 pole and TFCS114GRSBK or TFCS114GRDBK bypass brackets



**OVL1**  
hammered oval steel ring  
1 3/4"ID, 2 1/2"OD, 3 1/4"L  
Rings shown in 680 Aged Gold.

1 1/4"  
steel

## custom solutions: french returns

Our custom metal shop can create custom bent and mitered pole returns for any window. For more details, see pages 50–53 in the Custom Solutions section.



## poles



**RR125**  
1 1/4" round tube  
maximum length is 192 inches

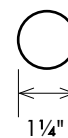

**RD125**  
1 1/16" round tube, heavy walled  
maximum length is 252 inches



**SRT2**  
1 1/4" solid rope  
maximum length is 228 inches use ring with minimum 1 3/4" ID

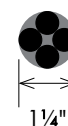

1 1/4" steel poles are sold in 1 foot increments, 2 foot minimum. Poles will be cut to specified length. Fall off will not be saved or shipped. **note:** twisted poles can appear uneven. Poles shown in 860 Grayed Brass.

## accessories



A B C

- A SBTN**  
steel baton, specify finish  
3/8" Dia  
specify length up to 60"  
**SBTN60**  
specify length up to 96"
- B FBTN**  
fiberglass baton, white  
3/8" Dia  
specify length up to 48"
- C ABTN-36** **NEW**  
clear acrylic baton  
3/8" Dia, available in 36"  
**ABTN-48** **NEW**  
clear acrylic baton  
3/8" Dia, available in 48"



## 1 $\frac{1}{2}$ " - 1 $\frac{3}{4}$ " steel

Our grandest in scale, the 1 $\frac{1}{2}$ " – 1 $\frac{3}{4}$ " steel collection is the perfect solution for windows that command a larger scale, luxurious window treatment. Two new classic finial designs have been added to this collection that provide the perfect proportion and style that will stand the test of time.

1 1/2" - 1 3/4"  
steel



**TFCS134190** **NEW**  
2 1/4" L x 3"W, 2 1/4" base  
880 Parchment  
pictured with pole RD175



**TFCS134100** **NEW**  
4 3/8" L x 3 1/4"W, 2 1/4" base  
860 Grayed Brass  
pictured with pole RD175



**EC3**  
1/3" L x 2"W, 2" base  
700 Graphite  
pictured with pole RR175



**SEC-2** **OH**  
1/4" L x 2"W, 2" base  
106 Bronze with Gold  
pictured with pole TRT



**FC1**  
1 1/3" L x 2 1/2"W, 2 3/8" base  
110 Flat Black with Gold  
pictured with pole RR175



**SF192**  
4 3/8" L x 2 3/4"W, 2 1/8" base  
760 Rustic Iron  
pictured with pole RR175



**SF138**  
4" L x 2 1/4"W, 2" base  
350G Statuary Bronze  
with Gold  
pictured with pole TRT



**SF-4**  
3 1/3" L x 2 1/2"W, 2" base  
110 Flat Black with Gold  
pictured with pole RR175



**SF150**  
3 1/4" L x 2 1/2"W, 2 1/4" base  
250B Platinum with  
Black Highlights  
pictured with pole TRT

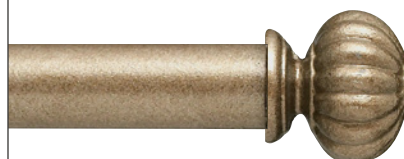

**SF63** **OH**  
2 1/2" L x 2 1/2"W, 2" base  
129 Antique Steel  
pictured with pole RR175



**SF151** **OH**  
3 1/2" L x 2 1/2"W, 2 1/8" base  
110 Flat Black with Gold  
pictured with pole RR175

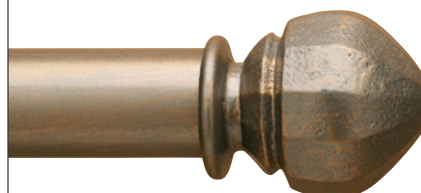

**SF140**  
3 3/8" L x 2 3/4"W,  
2 1/8" base  
150 Gray with Gold  
pictured with pole  
RR175



**1340HB**  
3 3/4"L x 3 7/8"W, 1 3/8" base  
110 Flat Black with Gold  
pictured with pole RR175

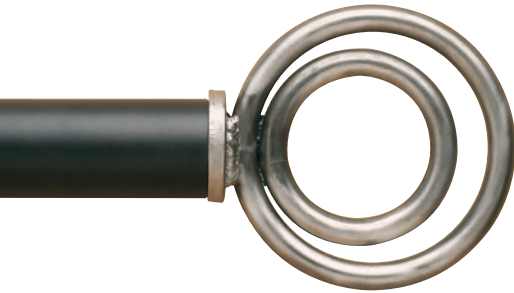

**SF228**  
5 1/8"L x 4 7/8"W  
100 Polished Steel\*  
pictured with pole RR175  
109 Flat Black

*\*please note: there is an upcharge for this custom finish; please refer to Retail Price List for details.*



**SF70**  
5 1/4"L x 3"W, 2" base  
270 Mahogany Rust  
pictured with pole RR175



**L651FC1**  
6 3/8"L x 3 7/8"W, 2 3/8" base  
110 Flat Black with Gold  
pictured with pole RR175

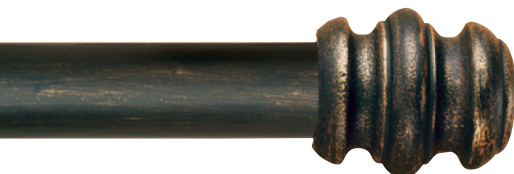

**SF90**  
3 3/4"L x 3"W, 2 1/8" base  
110 Flat Black with Gold  
pictured with pole RR175



**L848FC1** OH  
8 3/4"L x 4 1/4"W, 2 3/8" base  
110 Flat Black with Gold  
pictured with pole RR175



**LS385** OH  
5"L x 4 1/2"W  
250B Platinum with  
Black Highlights  
pictured with pole RR175



**LS385FC1**  
6 1/4"L x 4 1/2"W, 2 3/8" base  
250B Platinum with  
Black Highlights  
pictured with pole TRT



**SF96**  
4 1/4"L x 7"W, 2" base  
250 Platinum  
pictured with pole TRT



1 1/2" - 1 3/4"  
steel

# brackets

## standard



**BKT112-134**  
adjustable steel bracket, single  
3 7/8"-5 1/8" return, 1"W x 3 1/2"L  
backplate



**A17535**  
steel bracket, single  
3 1/2" return, 3/4"W x 2 1/2"L backplate



**B17535**  
steel bracket, single  
3 1/2" return, 3/4"W x 3 2/3"L backplate



**CS17535**  
steel bracket, single  
3 1/2" return, 2 1/2"W x 1 1/2"L backplate

**A1756**  
steel bracket, single  
6" return, 3/4"W x 2 1/2"L backplate

**B1756**  
steel bracket, single  
6" return, 3/4"W x 3 2/3"L backplate

**CS1756**  
steel bracket, single  
6" return, 2 1/2"W x 1 1/2"L backplate



**EB5**  
steel eyelet bracket, single  
3 1/2" return, 1"W x 3 1/2"H backplate,  
eyelet 1 7/8"ID

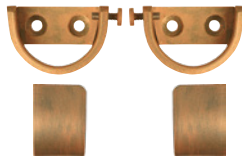

**IM175**  
1 3/4" steel inside mount brackets  
1 1/2"H x 2 3/8"W backplate, 3/4"Deep,  
1/8" thick backplate per bracket  
(sold in pairs)



**SELB**  
1 3/4" hinged elbow  
3"L, (2 1/3"L each side when bent),  
1 3/4" base

**EB6**  
steel eyelet bracket, single  
6" return, 1"W x 3 1/2"H backplate,  
eyelet 1 7/8"ID

*Return distance is from wall to center of cradle. Standard brackets shown in 680 Aged Gold.*

## custom solutions: bypass brackets

**CAUTION:** Bypass Brackets do not have full cradles. Standard brackets must be installed at each end to secure 1 3/4" pole.

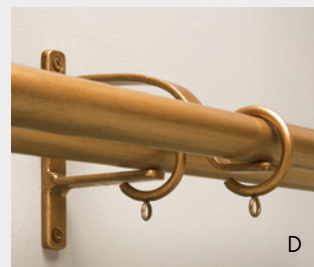
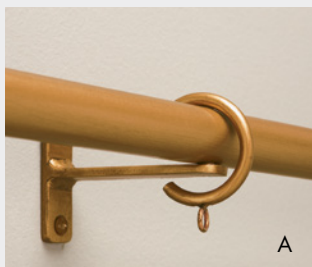

**A. SCB35**  
steel custom bypass bracket, single  
3 1/2" return, 3/4"W backplate x 2 1/2"  
or 3"L

**B. SCB6**  
steel custom bypass bracket, single  
6" return, 3/4"W backplate x 2 1/2"  
or 3"L

**C. SCBC**  
steel custom bypass bracket, single  
custom return, 3/4"W backplate  
x 2 1/2" or 3"L

**D. SCBCDBL**  
steel custom bypass bracket, double  
custom return, 3/4"W backplate  
x 5 1/4"L

Use with RD175 and RR175 poles and CR-SR12 c-ring. For more bypass bracket information, see page 56.

## custom solutions: brackets

The Finial Company is known for quality craftsmanship and can create custom brackets to match your job specifications. We can customize bracket dimensions, returns and finish on any pole for a custom fit on every job. For more custom solutions products see our custom brackets section on page 56.



**TBKT**  
custom steel t-bracket, single  
please specify:  
A. return (distance from wall to center of cradle)  
B. pole size and profile  
note: 3 1/2"H backplate comes standard, unless otherwise specified



**DBL1**  
custom steel bracket, double  
please specify:  
A. front pole size and profile  
B. back pole size and profile  
C. rings to be used, if any  
D. front and back returns (distance from wall to center of cradle)  
note: returns are contingent upon which poles and rings are chosen  
3 1/2"H backplate comes standard, unless otherwise specified



**BL4**  
custom steel ceiling mount bracket  
please specify:  
A. drop (distance from ceiling to top of pole)  
B. pole size and profile  
C. rings to be used, if any  
note: minimum drop is contingent upon which finial and ring are chosen.  
2 1/2"W backplate comes standard, unless otherwise specified



**FBKT**  
custom steel bracket, single  
please specify:  
A. return (distance from wall to center of cradle)  
B. pole size and profile  
note: 4 3/4"H backplate may not be modified

Return or drop distance in excess of 8" on any custom bracket will incur additional fees and requires addition of support arm. Custom brackets are shown unfinished, but will be hand painted in your selected Standard Finish (see back cover) or for a custom finish you can send us a finish sample and we'll prepare a strike-off sample for approval (see Retail Price List for custom finish charges).

## rings



**SR7**  
smooth steel ring  
2 1/4"ID, 2 3/4"OD



**FSR2**  
smooth heavy steel ring  
2"ID, 3"OD



**HSR175**  
hammered steel ring  
2"ID, 2 3/4"OD



**SR5**  
twisted steel ring  
2 5/8"ID, 3"OD



**OVL7**  
smooth oval steel ring  
2 1/4"ID, 2 3/4"OD, 3 1/2"L



**OVL175**  
hammered oval steel ring  
2"ID, 2 3/4"OD, 3 1/2"L



**CR-SR12**  
smooth steel c-ring  
2 5/8"ID, 3"OD use with RR175 or RD175 pole and SCB35, SCB6, SCBC or SCBCDBL bypass brackets

Rings shown in 680 Aged Gold.

1 1/2" - 1 3/4"  
steel

## custom solutions: french returns

Our custom metal shop can create custom bent and mitered pole returns for any window. For more details, see pages 50–53 in the Custom Solutions tab.



## poles



**RR175**  
1 3/4" Dia round tube  
maximum length is 192 inches

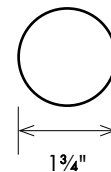

**RD175**  
1 5/8" Dia round tube, heavy walled  
maximum length is 288 inches

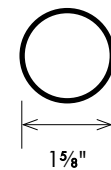

**TRT**  
1 1/2" Dia twisted tube  
maximum length is 216 inches use ring with  
minimum 2" ID

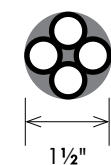

1 1/2"-1 3/4" steel poles are sold in 1 foot increments, 2 foot minimum. Poles will be cut to specified length. Fall off will not be saved or shipped. **note:** twisted poles can appear uneven. Poles shown in 860 Grayed Brass.

## accessories



- A SBTN**  
steel baton, specify finish  
3/8" Dia  
specify length up to 60"
- SBTN60**  
specify length up to 96"
- B FBTN**  
fiberglass baton, white  
3/8" Dia  
specify length up to 48"
- C ABTN-36** NEW  
clear acrylic baton  
3/8" Dia, available in 36"
- ABTN-48** NEW  
clear acrylic baton  
3/8" Dia, available in 48"



## outdoor hardware

With the growing popularity of indoor and outdoor spaces blending together, our outdoor hardware collection was designed to make sure those spaces are covered with style and functionality. We've curated an assortment of finials and accessories from our popular steel collection and created five weather resistant finishes that have been certified for outdoor use. Our 5 year warranty guarantees against rust and fading due to conditions such as UV exposure, humidity and sea spray.



# outdoor living made easy

## 5 custom finishes

available on all Outdoor Hardware products with protective high gloss, weather-resistant topcoat

## 5 year warranty

against rust and fading when properly maintained. Tested for outdoor use and guaranteed against:

- UV Exposure
- Humidity
- Sea Spray



Each order will include 2 oz. of finish and protective topcoat for periodic maintenance.

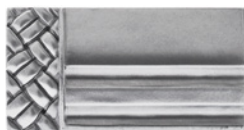

450-OH  
Aluminum Gloss



440-OH  
Soft Gold Gloss



103-OH  
Satin Black Gloss



105-OH  
Bronze Gloss



270-OH  
Mahogany Rust Gloss

### Outdoor Hardware Limited Warranty

All Outdoor Hardware is guaranteed to be free of manufacturing defects and is covered under our Manufacturers Limited Warranty. The product is guaranteed not to rust and the finish not to fade for 5 years if the product is maintained according to the "Product Care" information. In the event of rusting or fading, photography may be requested for finalization of claims on a case-by-case basis.

### Outdoor Hardware Product Care

Unlike indoor drapery hardware, outdoor hardware requires periodic maintenance. It is important that any damages or finish abrasion be repaired immediately. Any scratches incurred during installation must be repaired at that time. Stainless steel mounting hardware is recommended, but not included. Each order will include 2 oz. of finish and protective topcoat for periodic maintenance.

In addition, twice a year, it is important to clean and inspect the outdoor hardware for scratches or wear patterns that could expose the metal and result in rusting. This is very important for treatments with rings. If such areas are discovered, apply the paint finish sent with the order. When dry, apply the clear protective topcoat also provided.

**please note:** allow 10-15 business days for production of **Outdoor Hardware Collection**. Professional installation recommended due to weight of steel products. Brackets recommended every 3 feet. Splicing not recommended for steel rods.

# outdoor hardware



**L848-OH**  
7½"L x 4¼"W, 1" base  
103-OH Satin Black Gloss  
pictured with pole 75HSRB  
for ¾" and 1" poles



**SEC125-OH**  
¼"L x 1⅓"W, 1⅓" base  
450-OH Aluminium Gloss  
pictured with pole ST2  
for ¾", 1" and 1¼" poles



**EC135-OH**  
1¼"L x 2⅞"W, 2" base  
103-OH Satin Black Gloss  
pictured with pole RR125  
for 1" and 1¼" poles



**4519C-OH**  
3½"L x 2¾"W, 1¾" base  
440-OH Soft Gold Gloss  
pictured with pole RR100  
for 1" and 1¼" poles

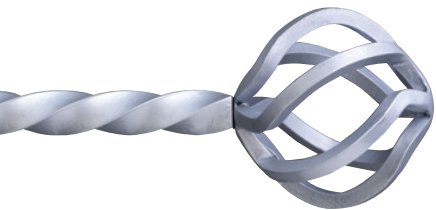

**LS385-OH**  
5"L x 4½"W  
450-OH Aluminium Gloss  
pictured with pole ST3  
for 1¼" and 1¾" poles



**SF63-OH**  
2½"L x 2½"W, 2" base  
105-OH Bronze Gloss  
pictured with pole RR125  
for 1¼" and 1¾" pole



**SEC2-OH**  
¼"L x 2"W, 2" base  
270-OH Mahogany Rust Gloss  
pictured with pole RR175  
for 1¼" and 1¾" poles



**L848FC1-OH**  
8¾"L x 4¼"W, 2⅞" base  
103-OH Satin Black Gloss  
pictured with pole RR175  
for 1¾" pole



**SF151-OH**  
3½"L x 2½"W, 2⅞" base  
103-OH Satin Black Gloss  
pictured with pole RR175  
for 1¾" pole

## outdoor rosettes



**R16-OH**  
3"Dia  
450-OH Aluminium Gloss



**R101-OH**  
5½"Dia  
270-OH Mahogany Rust Gloss with  
440-OH Soft Gold Gloss on petals\*



steel tieback post for rosettes  
bottom base 1¾"Dia  
**NBL2-OH** 2½" projection  
**NBL4-OH** 3½" projection  
**NBL6-OH** 6" projection

\*please note: there is a custom upcharge for this special finish treatment

# brackets



**steel bracket, single**  
**L235-OH** 3½" return, for ¾", 1" and 1¼" pole  
**L26-OH** 6" return, for ¾", 1" and 1¼" pole  
**B17535-OH** 3½" return, for 1¾" pole  
**B1756-OH** 6" return, for 1¾" pole



**steel eyelet bracket, single**  
**EB3-OH** 3½" return for 1" and 1¼" pole  
**EB4-OH** 6" return, for 1" and 1¼" pole  
**EB5-OH** 3½" return, for 1¾" pole  
**EB6-OH** 6" return, for 1¾" pole



**steel inside mount bracket**  
**IM125-OH** 1½"H x 1⅓"W backplate,  
¾"Deep, for 1", 1¼" pole,  
pair  
**IM175-OH** 1½"H x 2⅜"W backplate,  
¾"Deep for 1¾" pole, pair

*Return distance is from wall to center of cradle. Brackets shown in 103-OH Satin Black Gloss.*

# rings



**smooth steel ring**  
for ¾" pole:  
**SR1-OH** 1"ID, 1½"OD  
for 1" or 1¼" pole:  
**SR3-OH** 1½"ID, 2"OD  
for 1¾" pole:  
**SR7-OH** 2¼"ID, 2¾"OD



**hammered steel ring**  
for 1" or 1¼" pole:  
**HSR1-OH** 1¾"ID, 2½"OD  
for 1¾" pole:  
**HSR175-OH** 2"ID, 2¾"OD



**twisted steel ring**  
for 1", 1¼" or 1¾" pole:  
**SR5-OH** 2⅝"ID, 3"OD



**hammered smooth steel ring**  
for 1" or 1¼" pole:  
**OVL1-OH** 1¾"ID, 2½"OD  
for 1¾" pole:  
**OVL175-OH** 2"ID, 2¾"OD

*Please note: rings may abrade protective outdoor finish with frequent use. Please see Product Care for maintenance recommendations. All rings shown in 103-OH Satin Black Gloss.*

# poles



**75HSRB-OH**  
¾"Dia hammered solid steel pole, round  
maximum length is 115 inches

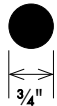

**ST2-OH**  
1" single twist solid steel pole  
maximum length is 228 inches; use ring with minimum 1½"ID

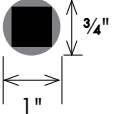

**ST3-OH**  
1" double twist solid pole  
maximum length is 228 inches; use ring with minimum 1½"ID

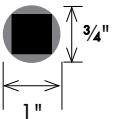

**RR100-OH** 1"Dia round tube  
**RR125-OH** 1¼"Dia round tube  
**RR175-OH** 1¾"Dia round tube  
 maximum length is 192 inches

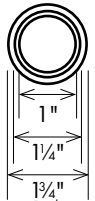

*Steel poles are sold in 1 foot increments, 2 foot minimum. Poles will be cut to specified length. Fall off will not be saved or shipped. Poles shown in 103-OH Satin Black Gloss.*

# tiebacks



**TTBH1-OH**  
4½"L x 1¼" projection  
103-OH Satin Black Gloss



**TTBH2-OH**  
3½"L x 1¼" projection  
103-OH Satin Black Gloss



# custom solutions

custom pole returns	50
custom brackets	56
custom accessories	57
custom arches	59
custom finishes	60







## custom solutions

The Finial Company is known for flexibility, and custom solutions are our specialty. Whether you need a custom bent or mitered return, unique bracket style, specialty window solution or a custom finish match, we can create one of a kind drapery hardware to complement your window design.



**Steel Pole 90° Bent Returns**

Round backplates: 1 3/8" Dia (for 1/2" 50SRB), 2" Dia (for 3/4" 75HSRB, 3/4" 75RD, 1 1/16" RD125 and 1 5/8" RD175). Rectangular backplates upon request.  
Rectangular backplates: 3"L x 1 1/2"W (for 1" 1SQ). Round backplates upon request.

Sold in one foot increments, 2 foot minimum charge.

Pictured: 3/4" 75RD with 90° bent returns with CR-SR75 steel c-rings; finish 150 Gray with Gold.

poles



**50SRB**

1/2" Dia steel, round solid pole  
maximum length is 240". Not available for use with  
bypass brackets and c-rings.

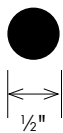

**75HSRB**

3/4" Dia hammered solid steel pole, round  
maximum length is 115". Not available for use with  
bypass brackets and c-rings.

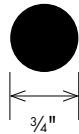

**75RD**

3/4" Dia solid steel pole, round  
maximum length is 220.

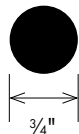

**1SQ** NEW

1" Dia smooth square tube  
maximum length is 288"; use with L125-SQ, L135-SQ  
brackets, SQRG1 ring. Not available for use with bypass  
brackets and c-rings.

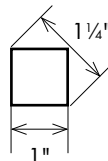

**RD125**

NEW

1 1/16" Dia round tube, heavy walled  
maximum length is 252".

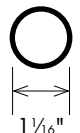

**RD175**

NEW

1 5/8" Dia round tube, heavy walled  
maximum length is 192".

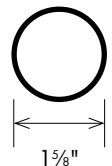

NOTE:

- Double pole treatments are also available with bent returns on the front pole.
- Available in all 50 hand-painted finishes and any custom finish.
- Pole length and return must be specified; please refer to the Retail Price List for required measurements.
- Poles shown in 860 Grayed Brass.

# brackets

# custom pole returns



**BKT050-1**  
adjustable steel bracket, single  
2½"-3⅓" return  
½" use with 50SRB pole

**BKT075-100**  
adjustable steel bracket, single 3½"-5" return  
¾" & 1" use with 75HSRB, 75RD, RR100, SRT1, ST2 or ST3 pole

**BKT118-138**  
adjustable steel bracket, single 3⅝"-4⅞" return  
1¼" use with RR125, RD125 or SRT2 pole

**BKT112-134**  
adjustable steel bracket, single 3⅞"-5⅛" return  
1¾" use with RR175, RD175 or TRT pole



**L135100**  
steel bracket, single  
3⅞" return  
¾", 1" use with 75HSRB, 75RD, RR100, SRT1, ST2 or ST3 pole

**L135**  
steel bracket, single  
3⅞" return  
1¼" use with RR125, RD125 or SRT2 pole

**A17535**  
steel bracket, single  
3½" return  
1¾" use with RR175, RD175 or TRT pole



**BKT050-3**  
steel extension bracket, single  
6" return  
½" use with 50SRB pole

**L16**  
steel extension bracket, single  
6" return  
1¼" use with RR100, RR125, RD125 or SRT2 pole

**A1756**  
steel extension bracket, single  
6" return  
1¾" use with RR175, RD175 or TRT pole



**L135-SQ**  
square bracket, single  
3½" return  
¾", 1" use with SRH75, 1SQ or SHT1 pole



**TFCS114GRSBK** **NEW**  
steel bypass bracket, single  
3½" return  
1", 1¼" use with RR100 or RR125 pole



**TFCS114GRDBK** **NEW**  
steel bypass bracket, double  
3" back and 6" front return  
1", 1¼" use with RR100 or RR125 pole

# rings



**SR05**  
smooth steel ring  
¾"ID, 1⅛"OD  
½" use with 50SRB

**SR1**  
smooth steel ring  
1"ID, 1½"OD  
¾" use with 75HSRB, 75RD

**SR3**  
smooth steel ring  
1½"ID, 2"OD  
1", 1¼" use with RR100, SRT1, ST2, ST3, RR125, RD125 or SRT2 pole

**SR7**  
smooth steel ring  
2¼"ID, 2¾"OD  
1¾" use with RR175, RD175 or TRT pole



**FSR1**  
smooth heavy steel ring  
1¾"ID, 2¾"OD  
1", 1¼" use with RR100, SRT1, ST2, ST3, RR125, RD125 or SRT2 pole

**FSR2**  
smooth heavy steel ring  
2"ID, 3"OD  
1¾" use with RR175, RD175 or TRT pole



**SQRG1**  
smooth square steel ring  
1⅝"ID, 2⅛"OD  
¾" or 1" use with 1SQ, SRH75 or SHT1 pole



**TFCS100SCRI** **NEW**  
smooth steel c-ring  
1½"ID, 2"OD  
1", 1¼" use with RR100 pole and TFCS114GRSBK or TFCS114GRDBK bypass brackets



**TFCS114MCRI** **NEW**  
smooth steel c-ring  
2"ID, 2⅝"OD  
1", 1¼" use with RR125 pole and TFCS114GRSBK or TFCS114BGRDBK bypass brackets

Brackets and rings shown coordinate with custom bent and mitered steel poles. Additional brackets and rings are available. Rings and brackets shown in 680 Aged Gold.



**Steel Pole 90° Mitered Returns**

Round Backplates: 1 3/8" Dia (for 1/2" pole), 2" Dia (for 3/4", 1" and 1 1/4" poles) and 3" Dia (for 1 3/4" pole).

Rectangular Backplates: 3"L x 1 1/2"W (for 1/2" 50SRB, 3/4" 75HSRB and 75RD, 1" 1SQ, RR100, ST2, ST3, SRT1, SHT1, 1 1/4" RR125, RD125, SRT2, and RR125) and 3 1/2"L x 2"W (for RR175 and TRT). Round backplates upon request.

Sold in one foot increments, 2 foot minimum charge. Ring inner diameter must clear the mitered pole corner, if used.

Pictured: 1" RR100 with 90° Mitered Returns with SR3 steel rings, finish 250 Platinum.

poles



**50SRB**

1/2" Dia steel, round solid pole  
maximum length is 240". Not available for use with  
bypass brackets and c-rings.



**75RD**

3/4" Dia solid steel pole, round  
maximum length is 220"



**SRH75**

3/4" Dia hammered solid steel pole, sq.  
maximum length is 228". Not available for use with  
bypass brackets and c-rings.

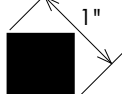

**75HSRB**

3/4" Dia hammered solid steel pole, round  
maximum length is 115". Not available for use with  
bypass brackets and c-rings.



**ST2**

1" Dia single twist solid steel pole  
maximum length is 228"; use ring with minimum 1 1/2" ID.  
Not available for use with bypass brackets and c-rings.

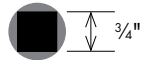

**ST3**

1" Dia double twist solid pole  
maximum length is 228"; use ring with minimum 1 1/2" ID.  
Not available for use with bypass brackets and c-rings.

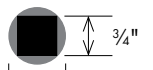

**SRT1**

1" Dia solid rope twist pole  
maximum length is 228"; use ring with minimum 1 1/2" ID.  
Not available for use with bypass brackets and c-rings.



**RR100**

1" Dia round tube  
maximum length is 192"





**1SQ**  
1" Dia smooth square tube  
maximum length is 288"; use with L125-SQ, L135-SQ brackets, SQRG1 ring. Not available for use with bypass brackets and c-rings.

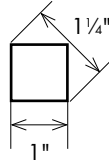

**SHT1**  
1" Dia square hammered tube  
maximum length is 228"; use with L125-SQ, L135-SQ brackets, SQRG1 ring. Not available for use with bypass brackets and c-rings.

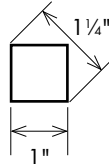

**RD125**  
1 1/8" Dia round tube, heavy walled  
maximum length is 252"

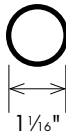

**SRT2**  
1 1/4" Dia solid rope  
maximum length is 228"; use ring with minimum 1 3/4" ID. Not available for use with bypass brackets and c-rings.

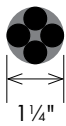

**RR125**  
1 1/4" Dia round tube  
maximum length is 192"

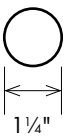

**TRT**  
1 1/2" Dia twisted tube  
maximum length is 216"; use ring with minimum 2" ID. Not available for use with bypass brackets and c-rings.

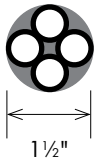

**RD175**  
1 3/8" Dia round tube, heavy walled  
maximum length is 288"

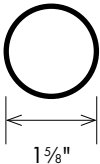

**RR175**  
1 3/4" Dia round tube  
maximum length is 192"

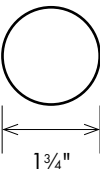

**NOTE:**

- Double pole treatments are also available with mitered returns on the front pole.
- Available in all 50 hand-painted finishes and any custom finish.
- Pole length and return must be specified; please refer to the Retail Price List for required measurements.
- Twisted poles can appear uneven.

## custom solutions: bypass brackets and c-rings

**CAUTION:** Bypass Brackets do not have full cradles. Standard brackets must be installed at each end to secure pole.

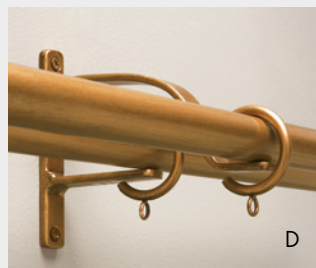
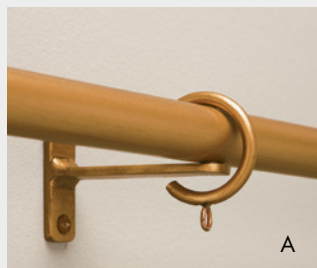

**A. SCB35**  
steel custom bypass bracket, single 3 1/2" return, 3/4"W backplate x 2 1/2" or 3"H

**B. SCB6**  
steel custom bypass bracket, single 6" return, 3/4"W backplate x 2 1/2" or 3"H

**C. SCBC**  
steel custom bypass bracket, single custom return, 3/4"W backplate x 2 1/2" or 3"H

**D. SCBCDBL**  
steel custom bypass bracket, double custom return, 3/4"W backplate x 5 1/4"H

Use all bypass brackets with 75RD, RR100, RR125, RD125, RR175 and RD175 poles.

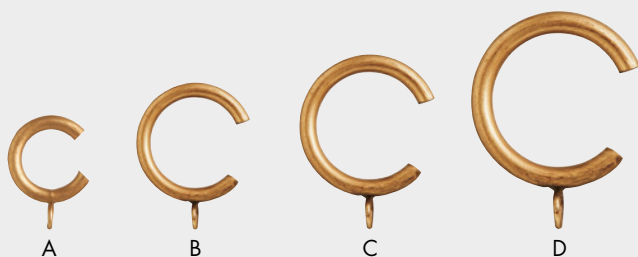

**A. CR-SR75**  
smooth steel c-ring  
1 1/4" ID, 1 3/4" OD  
3/4" use with 75RD

**B. CR-SR3**  
smooth steel c-ring  
1 1/2" ID, 2" OD  
1", 1 1/4" use with RR100 or RD125 pole

**C. CR-SR7**  
smooth steel c-ring  
2 1/4" ID, 2 3/4" OD  
1 1/4" use with RR125

**D. CR-SR12**  
smooth steel c-ring  
2 5/8" ID, 3" OD  
1 3/4" use with RR175 or RD175 pole



## wood pole mitered returns

- We can custom miter wood poles and traverse fascia to cover any corner or bay window.
- Mitered returns create a finished look on wood fascia and allow you to seamlessly cover a specialty window with angles.
- Single and double pole treatments are available with mitered returns.
- Mitered return fees are charged per corner. Please reference the Retail Price List for a list of required measurements and surcharges.

*Wood poles sold in 2 foot increments, 2 foot minimum charge.*

*Ring inner diameter must clear the mitered pole corner, if used. See reference chart in Retail Price List.*

miters for wood poles and wood fascias are great for situations like these...

- We can miter our wood poles at any angle for you.



Shown: 90° inside corner miter for 225WG wood pole, WL1 steel brackets, finish 710 Tarnished Silver



90° inside corner



Shown: 90° outside corner miter for 225WS wood pole, WL1 steel brackets, finish 710 Tarnished Silver



90° outside corner

- We cannot miter traverse system tracks, but the traverse wood fascia can connect and miter at the corner.



Shown: 120° mitered bay corner for light duty corded traverse system, 225FL wood fascia, finish 740 Smoky Mocha; bronze track, bracket, and components



mitered bay corner  
(angle varies)



## custom brackets

The Finial Company is known for quality craftsmanship and can create custom brackets to match your job specifications. We can customize bracket dimensions, returns and finish on any pole for a custom fit on every job.



**TBKT**  
custom steel t-bracket, single

*please specify:*  
A. return (distance from wall to center of cradle)  
B. pole size and profile

**note:** 3½"H backplate comes standard, unless otherwise specified



**DBL1**  
custom steel bracket, double

*please specify:*  
A. front pole size and profile  
B. back pole size and profile  
C. rings to be used, if any  
D. front and back returns (distance from wall to center of cradle)

**note:** returns are contingent upon which poles and rings are chosen

3½"H backplate comes standard, unless otherwise specified



**BL4**  
custom steel ceiling mount bracket

*please specify:*  
A. drop (distance from ceiling to top of pole)  
B. pole size and profile  
C. rings to be used, if any

**note:** minimum drop is contingent upon which finial and ring are chosen.

2½"W ceiling plate comes standard, unless otherwise specified



**FBKT**  
custom steel bracket, single

*please specify:*  
A. return (distance from wall to center of cradle)  
B. pole size and profile

**note:** 4¾"H backplate may not be modified

Return or drop distance in excess of 8" on any custom bracket will incur additional fees and requires addition of support arm. Custom brackets are shown unfinished, but will be hand painted in your selected Standard Finish (see back cover) or for a custom finish you can send us a finish sample and we'll prepare a strike-off sample for approval (see Retail Price List for custom finish charges).

## custom bypass brackets

Our bypass brackets and c-rings allow continuous ring movement along the length of your pole. These work particularly well for long one-way draw treatments, unusually wide windows, and walls featuring multiple windows.

**CAUTION:** Bypass Brackets do not have full cradles. Standard brackets must be installed at each end to secure pole.

**SCB35**  
steel bypass bracket, single  
standard 3½" return, ¾"W backplate x 2½" or 3"L



**SCB35**



**SCB6**  
steel bypass bracket, single  
6" return, ¾"W backplate x 2½" or 3"L

**SCBC**  
steel custom bypass bracket, single  
custom return, ¾"W backplate x 2½" or 3"L

*please specify:*  
A. 75RD (¾") RR100 (1"), RR125 (1¼"), RD125 (1¼"), RR175 (1¾") pole, or RD175 (1¾") pole

B. return (distance from wall to center of cradle)

**SCBCDBL**  
steel custom bypass bracket, double  
custom front and back return, ¾"W backplate x 5¼"L

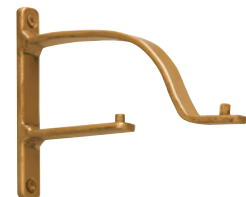

**SCBCDBL**

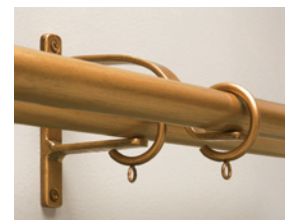

*please specify:*  
A. 75RD (¾")  
RR100 (1"),  
RR125 (1¼"),  
RD125 (1¼"),  
RR175 (1¾") pole, or  
RD175 (1¾") pole

B. front and back returns (distance from wall to center of cradle)

**note:** return may be restricted by the size of poles and rings specified

Return or drop distance in excess of 8" on any custom bracket will incur additional fees and requires addition of support arm.

# custom accessories

# custom accessories

Want to further customize your steel products? We can add a variety of decorative items to our steel products for you. *Additional charges apply.*



**SL**  
short leaf  
6"L x 1¾"W

This leaf can be welded to the front of any steel bracket with a maximum return of 3½".

When ordering your bracket, please specify addition of SL.



**LL**  
long leaf  
11½"L x 1¾"W

This leaf can be welded to the front of any steel bracket with a maximum return of 8".

When ordering your bracket, please specify addition of LL.



**SL3**  
steel leaf  
2¼"L x 1¾"W

SL3 welded to SR3 ring

This leaf can be welded to any steel ring or steel bracket.

When ordering your ring or bracket, please specify addition of SL3, and in what position it should be attached.

*SL3 welded to SR3 ring*

Add any rosette medallion or end cap to the front of any standard or custom steel bracket.

When ordering your bracket, please specify addition of rosette medallion and the following:

1. which rosette medallion or end cap to be added
2. attachment method:
  - a. machine screw (medallion may easily be changed later)
  - b. weld (permanent attachment; only available for steel rosettes or steel end caps)

**please note:** rosette medallions and brackets sold separately additional charges apply

For additional information on how to order custom brackets, please refer to the Retail Price List.



*EC3 welded to front of bracket L135, RR100 pole, SR3 rings, finish 620 Weathered Iron. See pages 89-91 for Rosette options.*

## swing arms

Swing Arms can be a nice solution for window treatments in front of doors, shutters, and other unique areas where the drapery panel needs to conveniently swing out of the way.



*L9328 finial, 350G Statuary Bronze with Gold Shown with scroll.*

**large swing arm with scroll**  
maximum length 36"  
1"Dia pole RD125  
8½"H x 1¼"W backplate  
L9328 finial included: 1¼"Dia  
350G Statuary Bronze with Gold

**please note:** Other finials may be substituted. Replacement finial sold separately.



*K659 finial, 350G Statuary Bronze with Gold Shown without scroll.*

**large swing arm without scroll**  
maximum length 36"  
1"Dia pole RD125  
8½"H x 1¼"W backplate  
L9328 finial included: 1¼"Dia  
350G Statuary Bronze with Gold

**please note:** Other finials may be substituted. Replacement finial sold separately.



*EC4 finial, 350G Statuary Bronze with Gold*

**small swing arm**  
maximum length 20"  
½"Dia pole 50SRB  
4"H x ¾"W backplate  
EC4 finial included: ¾"L x 1½"W  
350G Statuary Bronze with Gold

**please note:** Other finials may be substituted. Replacement finial sold separately.

For additional information on how to order, please refer to the Retail Price List.

# finial adaptors





If the finial you want isn't shown in the diameter you need, order a finial adaptor for a nominal fee. The finial adaptor acts as the new finial base.

Finials are located in certain diameter categories based on the following criteria:

- the finial base fits the pole without additional modification
- finial shape and size is in proportion to the pole diameter

Finial Adaptor Tips:

- It is typically easier and more visually pleasing to adapt a finial to a larger diameter pole, rather than a smaller diameter pole.
- Many finials are located in multiple size categories because they look appropriate for several pole sizes; you may not need an adaptor.

base adaptor size	use for pole diameters
 FA-S: 1 3/8" Dia	1/2", 3/4", 1", 1 1/4"
 FA-M: 2" Dia	1 1/2" - 1 3/4"
 FA-L: 3" Dia	2" - 2 1/4"
 FC1: 2 3/8" Dia	1 1/2" - 1 3/4", 2" - 2 1/4"

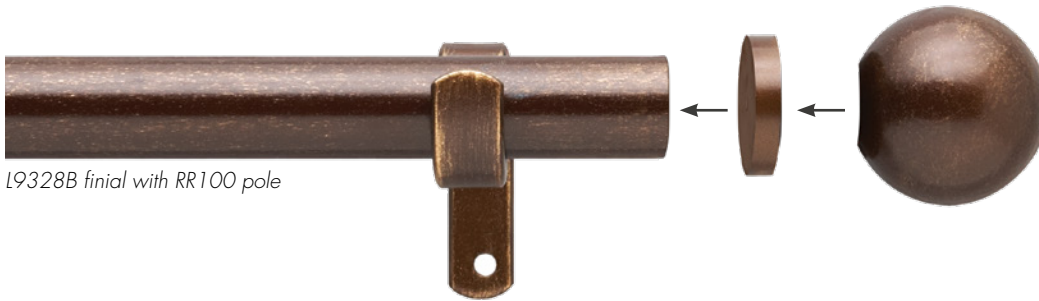

L9328B finial with RR100 pole

# custom tiebacks



**TBA**  
 6"L back arm x 4 1/2"L front arm,  
 4 1/2" projection  
 100 Polished Steel\*  
 attach finial or rosette of choice to face or tip of TBA.  
 pictured with L651 finial  
 finial sold separately



**STBA1**  
 8"L back arm x 8"L front arm,  
 6 1/2" projection  
 610 Cobalt Bronze  
 attach finial or rosette of choice  
 pictured with R73 rosette  
 rosette sold separately

*\*please note: there is an upcharge for this custom finish; please refer to Retail Price List for details.*

# arched window solutions

custom  
arches

- Available for 1/2" 50SRB, 3/4" 75RD and 75HSRB, 1" SRT1, 1 1/4" RD125, and SRT2 poles only.
- Some poles will need to be cut at apex (center) for shipping; some arches cannot be achieved.
- Arched poles with splices are subject to additional bending fees.

**IMPORTANT:** A template is required to ensure accuracy of production. For information on how to create your template, please refer to the Retail Price List.

## standard arch

arch height is equal or greater than half the arch width

## eyebrow arch

arch height is less than half the arch width

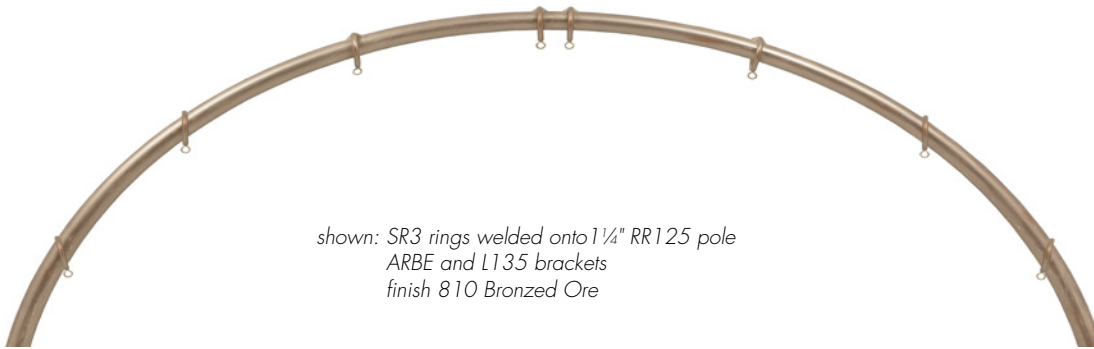

shown: SR3 rings welded onto 1 1/4" RR125 pole  
ARBE and L135 brackets  
finish 810 Bronzed Ore

### ARBC arched rod center bracket

Please specify return (distance from wall to center of cradle)

**note:** cannot be used for installations with rings (brackets without eyelet cradles may be substituted)



### ARBE arched rod end brackets

Sold in pairs only  
Please specify return (distance from wall to center of cradle) and pole being used.  
Cups are custom made to style of pole.

**note:** outer ring can only reach 1 1/2" from end of pole due to the bracket cup



## do you need a vertical or horizontal arch?

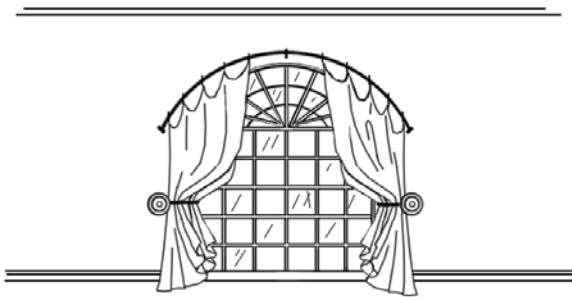

Vertical Arch Installation  
great for arched windows

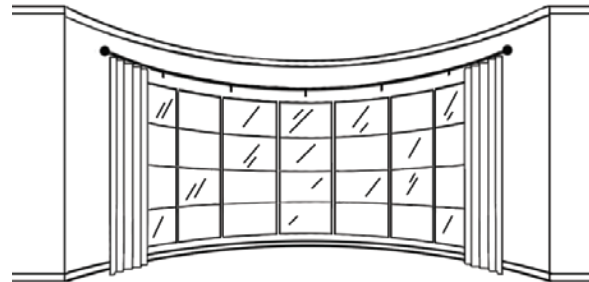

Horizontal Arch Installation  
great for curved bay windows

**please note:** If using rings for vertical arch installation, rings must be welded into place. Ring position must be noted on your template. Outermost rings must be a minimum of 1 1/2" from end of pole due to ARBE bracket cup. Rings sold separately.

Any steel bracket or finial may be used for this type of arch.

For additional information on how to order, please refer to the Retail Price List.

[www.thefinialcompany.com](http://www.thefinialcompany.com)

# custom finishes

Beyond our standard finishes, our artisans can match any finish, fabric swatch, wood trim or paint color specified from your favorite paint supplier allowing you to create complementary custom finishes in subtle or bold and vivid color palettes. The Finial Company can provide a strike-off sample on any wood or steel pole profile, upon request. Please reference the Retail Price List for required specifications and surcharges.



## polished steel finish

Many, but not all, of our raw steel products can be polished and given a clear topcoat to achieve a finished look. Steel is not uniform in color tone and will vary in shades of gray and silver. Polishing raw steel parts requires considerably more preparation work than our other finishes and therefore incurs additional charges. Steel items that cannot be polished are listed in The Finial Company Retail Price List.

## adding clear topcoat

For an additional charge, we can add a clear topcoat to any finish to achieve your preferred sheen level.



matte



satin



high gloss

## painting fees

We will repaint hardware from The Finial Company or another manufacturer at the customer's request. We will also paint unfinished hardware from any manufacturer.

## touch-up paint

Touch-up paint can be sent to the customer on request, for an additional charge.



*Please refer to the Retail Price List for more details and a list of applicable charges.*



## wood & resin

1 <sup>3</sup> / <sub>8</sub> " collection	61
2"- 2 <sup>1</sup> / <sub>4</sub> " collection	68
3" collection	81
rosettes	88
tiebacks	93
crests	94

1<sup>3</sup>/<sub>8</sub>"  
2"-2<sup>1</sup>/<sub>4</sub>"  
3"

1 3/8"

actual pole sizes

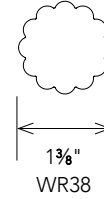
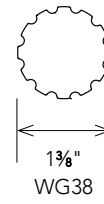
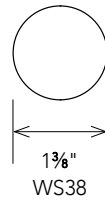
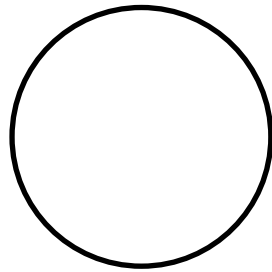

2"-2 1/4"

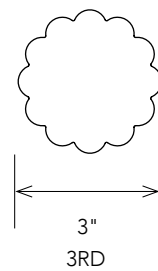
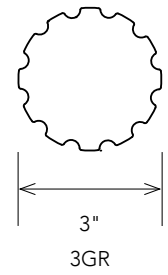
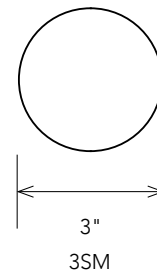
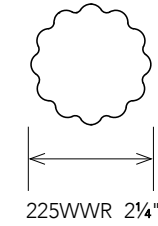
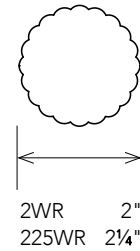
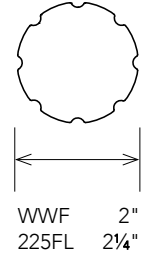
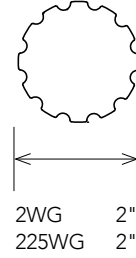
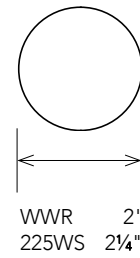
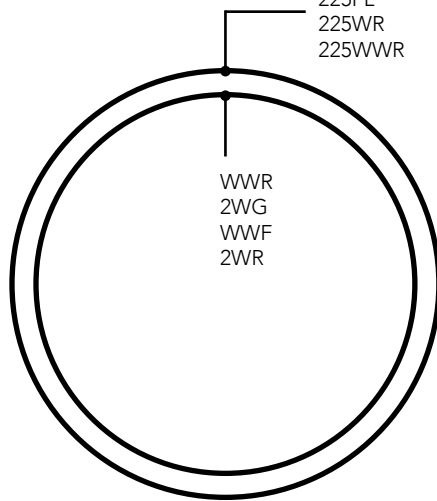



## 1<sup>3</sup>/<sub>8</sub>" wood & resin

In our wood & resin collections, The Finial Company offers the timeless classics that never go out of style and the transitional new favorites that accentuate today's modern aesthetic. The 1<sup>3</sup>/<sub>8</sub>" wood & resin collection features over 10 new finial designs with sleek profiles and exceptional design details available in our 50 hand painted standard finish options.



1 3/8"  
wood & resin



**TFCR138190** **NEW**  
1"L x 1 7/8"W, 1 7/8" base  
810 Bronzed Ore  
pictured with pole  
WS38



**TFCR138191** **NEW**  
1 1/4"L x 2 1/4"W, 2" base  
840 White with Gold  
Accents  
pictured with pole WG38



**TFCR138192** **NEW**  
2 1/4"L x 2 1/4"W, 1" base  
610 Cobalt Bronze  
pictured with pole WS38



**RF5**  
1"L x 1 3/4"W, 1 3/8" base  
107 Bronze with Gold  
and Gray  
pictured with pole WG38



**F138-9**  
5/8"L x 2 1/8"W, 1 7/8" base  
640 Oil Rubbed Bronze  
pictured with pole WS38



**TFCR138121** **NEW**  
2 7/8"L x 2 7/8"W, 2" base  
810 Bronzed Ore  
pictured with pole WS38



**TFCR138130** **NEW**  
3 1/2"L x 4 3/8"W, 2" base  
710 Tarnished Silver  
pictured with pole  
WNF38



**TFCR138125** **NEW**  
3 7/8"L x 2 1/2"W, 1 7/8" base  
800 Charred Toasted Oak  
pictured with pole WNF38

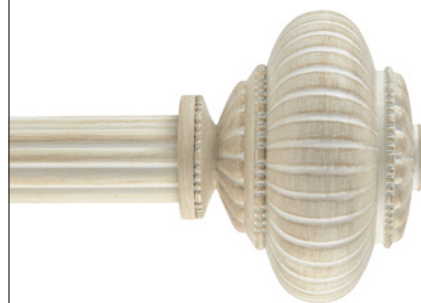

**TFCR138131** **NEW**  
3 7/8"L x 4 5/8"W, 2" base  
880 Parchment  
pictured with pole WR38



**TFCR138170** **NEW**  
glass finial  
3 3/8"L x 3 1/4"W, 1 7/8" base  
110 Flat Black with Gold  
pictured with pole WNF38



**TFCR138171** **NEW**  
glass finial  
3 3/8"L x 3 1/4"W, 2 1/8" base  
840 White with Gold  
Accents  
pictured with pole WS38



**TFCR138124** **NEW**  
3 7/8"L x 3 1/4"W, 2" base  
790 Vintage Bronze  
pictured with pole WS38



**F138-3**  
4"L x 3"W, 1 7/8" base  
660 Antique White  
pictured with pole WNF38



**TFCR138172** **NEW**  
glass finial  
4 1/2"L x 4 3/4"W, 2" base  
112 Silver with Gold  
pictured with pole WR38



**TFCR138126** **NEW**  
3 7/8"L x 3 1/4"W, 2" base  
810 Bronzed Ore  
pictured with pole WS38



**TFCR138165** **NEW**  
5 3/4"L x 3 1/8"W, 2" base  
870 Chalet Gray  
pictured with pole WNF38



**TFCR138110** **NEW**  
3 1/2"L x 3 3/8"W, 1 7/8" base  
107 Bronze with Gold  
and Gray  
pictured with pole WNF38



**TFCR138164** **NEW**  
4 3/8"L x 3 1/8"W, 4 3/8" base  
690 Champagne  
pictured with pole WS38

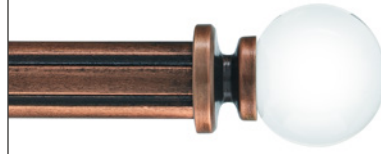

**F138-5C**  
crystal finial  
3 1/4"L x 2 1/2"W, 1 7/8" base  
730 Rose Gold  
pictured with pole WNF38

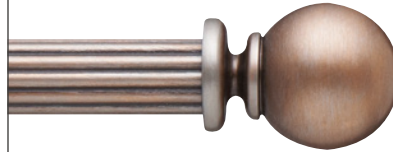

**F138-5S**  
3 1/4"L x 2 1/2"W, 1 7/8" base  
760 Rustic Iron  
pictured with pole WR38



**F138-8**  
3 1/4"L x 3"W, 1 7/8" base  
650 Hickory  
pictured with pole WS38

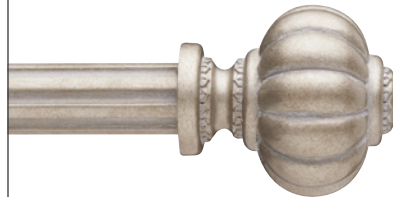

**F138-7**  
3 5/8"L x 3 1/4"W, 1 7/8" base  
630 Ash Gray  
pictured with pole WG38



**F138-2**  
4 7/8"L x 3 1/8"W, 1 7/8" base  
620 Weathered Iron  
pictured with pole WNF38



**F138-1**  
4 7/8"L x 2 7/8"W, 2" base  
610 Cobalt Bronze  
pictured with pole WR38

1 3/8"  
wood & resin

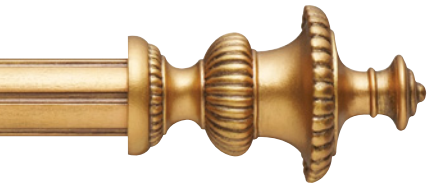

**RF86**  
5"L x 3"W, 1 3/4" base  
750 Polished Gold  
pictured with WNF38



**F138-4C**  
crystal finial  
3 1/4"L x 3 3/4"W (2 5/8" Sq),  
1 7/8" base  
740 Smoky Mocha  
pictured with pole WS38

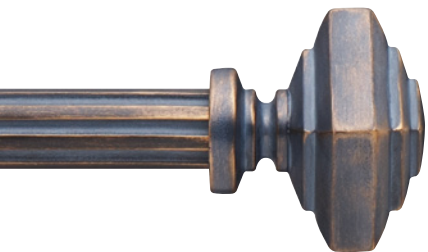

**F138-4S**  
3 1/4"L x 3 3/4"W (2 5/8" Sq),  
1 7/8" base  
790 Vintage Bronze  
pictured with pole WG38



**F138-6**  
3 1/4"L x 3 1/2"W, 1 7/8" base  
600 Gilded Red  
pictured with pole WS38

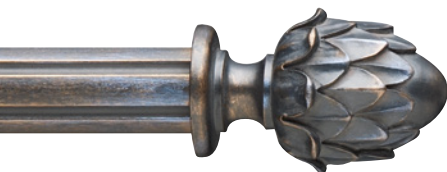

**WW190**  
4 1/4"L x 2 1/2"W, 1 3/4" base  
610 Cobalt Bronze  
pictured with pole WNF38



**GB4**  
crystal finial  
4"L x 2 1/2"W, 1 3/4" base  
109 Flat Black  
pictured with pole WS38



**138EC**  
wood finial  
1 1/4"L x 2 3/8"W, 2 3/8" base  
240 Walnut  
pictured with pole WS38

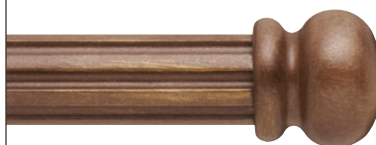

**38EC**  
wood finial  
1 1/2"L x 1 7/8"W, 1 7/8" base  
780 Hazelwood  
pictured with pole WG38



**387**  
wood finial  
3"L x 2 3/8"W, 1 7/8" base  
720 Tawny Oak  
pictured with pole WNF38

# brackets

1 3/8"  
wood & resin



**38B**  
wood bracket, single  
2 1/2" return, 1"W x 4 1/4"L backplate

**WWB3**  
wood bracket, single  
3 1/2" return, 1"W x 4 1/4"L backplate



**38EB3**  
wood bracket, single  
3 1/2" return, 2"Dia backplate

**38EB5**  
wood bracket, single  
6 3/4" return, 2 3/8"Dia backplate



**38ISM**  
1 3/8" inside mount wood brackets  
1 7/8"H x 1 7/8"W backplate, 1 3/8" Deep,  
1/2" thick backplate per bracket  
(sold in pairs)



**BKT118-138**  
adjustable steel bracket, single  
3 5/8"-4 7/8" return, 1"W x 3 1/4"L backplate



**A17535**  
steel bracket, single,  
3 1/2" return, 3/4"W x 2 1/2"L backplate



**TFCS138WSSBK** **NEW**  
steel bracket, single  
3 1/2" return, 3/4"W x 3 3/4"L backplate

**A1756**  
steel bracket, single  
6" return, 3/4"W x 2 1/2"L backplate

**TFCS138WSS6BK** **NEW**  
steel bracket, double  
6" return, 3/4"W x 3 3/4"L backplate



**TFCS138WSDBK** **NEW**  
steel bracket, double  
6" front and 3" back return,  
3/4"W x 3 3/4"L backplate



**TFCS138GRSBK** **NEW**  
steel bypass bracket, single  
3 1/2" return, 3/4"W x 3 3/4"L backplate



**TFCS138GRDBK** **NEW**  
steel bypass bracket, double  
6" front and 3" back return,  
3/4"W x 3 3/4"L backplate



**TFCS138MCMBK** **NEW**  
1 3/8" steel ceiling mount bracket  
2"Dia ceiling plate, 2 3/4"H, 2 5/8" drop  
(distance from ceiling to bottom of pole)

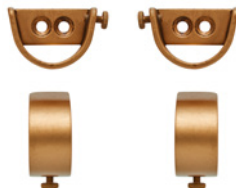

**TFCS138MIBK** **NEW**  
1 3/8" steel inside mount brackets  
1 1/4"H x 1 7/8"W backplate, 1" Deep,  
1/4" thick backplate per bracket  
(sold in pairs)



**TFRC138REL** **NEW**  
1 3/8" hinged elbow  
4"L (2 2/3"L each side when bent),  
1 3/8" base

Return distance is from wall to center of cradle. Steel brackets shown in 680 Aged Gold. Wood brackets shown in 117 Walnut Gold.

## custom solutions: brackets

The Finial Company is known for quality craftsmanship and can create custom brackets to match your job specifications. We can customize bracket dimensions, returns and finish on any pole for a custom fit on every job. For more custom solutions products see our custom brackets section on page 56.



**TBKT**  
custom steel t-bracket, single  
please specify:  
A. return (distance from wall to center of cradle)  
B. pole size and profile  
note: 3½"H backplate comes standard, unless otherwise specified



**DBL1**  
custom steel bracket, double  
please specify:  
A. front pole size and profile  
B. back pole size and profile  
C. rings to be used, if any  
D. front and back returns (distance from wall to center of cradle)  
note: returns are contingent upon which poles and rings are chosen  
3½"H backplate comes standard, unless otherwise specified



**BL4**  
custom steel ceiling mount bracket  
please specify:  
A. drop (distance from ceiling to top of pole)  
B. pole size and profile  
C. rings to be used, if any  
note: minimum drop is contingent upon which finial and ring are chosen.  
2½"W backplate comes standard, unless otherwise specified



**FBKT**  
custom steel bracket, single  
please specify:  
A. return (distance from wall to center of cradle)  
B. pole size and profile  
note: 4¾"H backplate may not be modified

Return or drop distance in excess of 8" on any custom bracket will incur additional fees and requires addition of support arm. Custom brackets are shown unfinished, but will be hand painted in your selected Standard Finish (see back cover) or for a custom finish you can send us a finish sample and we'll prepare a strike-off sample for approval (see Retail Price List for custom finish charges).

## rings



**38FLR**  
fluted wood ring  
2"ID, 2¾"OD



**SR13**  
smooth steel ring  
1¾"ID, 2¼"OD



**FSR1**  
smooth heavy steel ring  
1¾"ID, 2¾"OD



**HSR1**  
hammered steel ring  
1¾"ID, 2½"OD



**OVL3**  
smooth oval steel ring  
1½"ID, 2"OD, 2½"L



**OVL1**  
hammered oval steel ring  
1¾"ID, 2½"OD, 3¼"L



**TFCS138MCRI** NEW  
smooth steel c-ring  
2"ID, 2½"OD

Wood rings shown in 117 Walnut Gold.  
Steel rings shown in 680 Aged Gold.

# poles

1 3/8"  
wood & resin



WS38 1 3/8" smooth wood

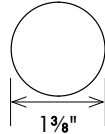

WNF38 1 3/8" fluted wood

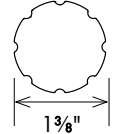

WG38 1 3/8" grooved wood

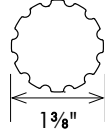

WR38 1 3/8" reeded wood

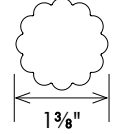

1 3/8" wood poles are sold in 2 foot increments, 2 foot minimum. Poles will be cut to specified length. Fall off will not be saved or shipped. Maximum length of all 1 3/8" wood poles is 144". Poles shown in 117 Walnut Gold.

# accessories



**A SBTN**  
steel baton, specify finish  
3/8"Dia  
specify length up to 60"

**SBTN60**  
specify length up to 96"

**B FBTN**  
fiberglass baton, white  
3/8"Dia  
specify length up to 48"

**C ABTN-36** **NEW**  
clear acrylic baton  
5/8"Dia, available in 36"

**ABTN-48** **NEW**  
clear acrylic baton  
5/8"Dia, available in 48"

**D WBTN**  
wood baton, specify finish  
3/8"Dia  
specify length up to 48"

**E EPBTN-1**  
wood baton, specify finish  
5/8"Dia, handle: 6 1/8"L x 1 1/4"Dia  
specify length up to 48"

**F EPBTN-2**  
wood baton, specify finish  
5/8"Dia, handle: 5 3/4"L x 1 1/2"Dia  
specify length up to 48"



MB138 band, R24 rosette, WVS38 pole, finish 200 Walnut Gold with Gray Accents

**MB138**  
metal band, attaches any rosette to front of 1 3/8"Dia pole. Use with 1 3/8" pole only. For more information on metal bands, see page 92.

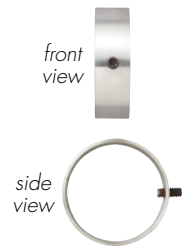



## 2"-2<sup>1</sup>/<sub>4</sub>" wood & resin

Endless design options and solutions are available in our 2"-2<sup>1</sup>/<sub>4</sub>" wood & resin collection. With over 20 new finial designs and the largest variety of pole, ring and bracket styles to choose from this collection is a go to for any window design need.

# 2" - 2 1/4" wood & resin



**TFCR214190** **NEW**  
1" L x 2 7/8" W, 2 7/8" base  
620 Weathered Iron  
pictured with pole WVWR



**TFCR214191** **NEW**  
1 1/2" L x 3 1/8" W, 2 7/8" base  
112 Silver with Gold  
pictured with pole WVWR



**TFCR214192** **NEW**  
1 1/4" L x 3 1/4" W, 2 7/8" base  
810 Bronzed Ore  
pictured with pole 225FL



**TFCR214193** **NEW**  
1 1/2" L x 3 5/8" W, 2 7/8" base  
850 Soft Brass  
pictured with pole 225WG



**TFCR214194** **NEW**  
1 3/8" L x 3" W, 2 7/8" base  
790 Vintage Bronze  
pictured with pole 225WS



**TFCR214195** **NEW**  
1 1/4" L x 3 1/8" W, 2 7/8" base  
870 Chalet Gray  
pictured with pole 2WG



**TFCR214196** **NEW**  
1 1/2" L x 3" W, 3" base  
800 Charred Toasted Oak  
pictured with pole WWF

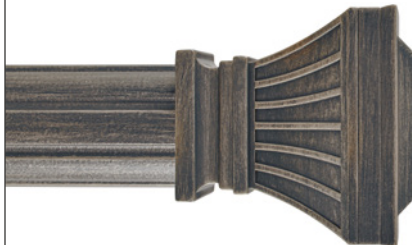

**TFCR214110** **NEW**  
4 3/8" L x 4 1/4" W, 2 3/4" base  
860 Grayed Brass  
pictured with pole 225FL



**TFCR214121** **NEW**  
3 1/4" L x 3 1/2" W, 2 3/4" base  
840 White with Gold Accents  
pictured with pole 225FL



**TFCR214122** **NEW**  
4 1/2" L x 4 3/4" W, 2 7/8" base  
110 Flat Black with Gold  
pictured with pole 225FL



2" - 2 1/4"  
wood & resin



TFCR214123 **NEW**  
4 5/8" L x 4 3/8" W, 2 3/4" base  
620 Weathered Iron  
pictured with pole 225WS



TFCR214124 **NEW**  
5" L x 4 5/8" W, 2 3/4" base  
112 Silver with Gold  
pictured with pole 225WS



TFCR214125 **NEW**  
5 3/8" L x 3 1/2" W, 2 3/4" base  
760 Rustic Iron  
pictured with pole WWF



TFCR214130 **NEW**  
4 3/8" L x 5 1/2" W, 3" base  
620 Weathered Iron  
pictured with pole 225WWR

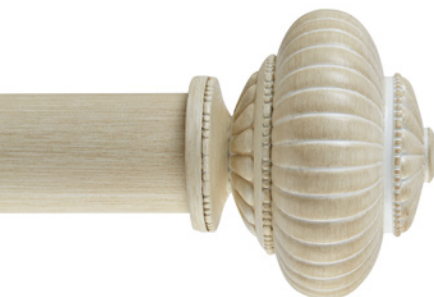

TFCR214131 **NEW**  
4 5/8" L x 5 3/8" W, 2 7/8" base  
880 Parchment  
pictured with pole 225WS

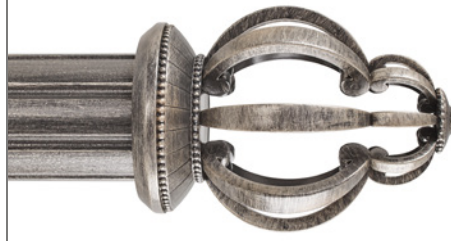

TFCS214150 **NEW**  
6 1/2" L x 4" W, 2 3/4" base  
860 Grayed Brass  
pictured with pole  
225WG

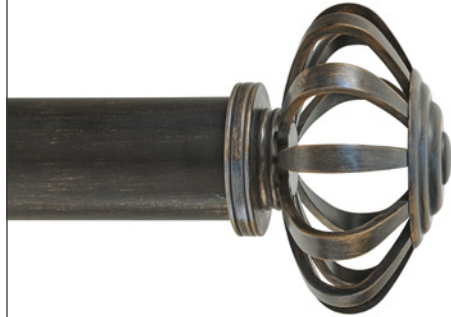

TFCS214151 **NEW**  
3 7/8" L x 5 5/8" W, 2 3/4" base  
610 Cobalt Bronze  
pictured with pole WWR

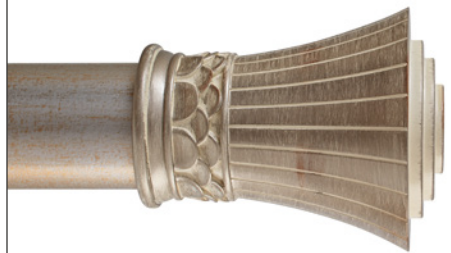

TFCR214163 **NEW**  
5 3/8" L x 4 3/8" W, 2 7/8" base  
810 Bronzed Ore  
pictured with pole WWR



TFCR214164 **NEW**  
5 1/2" L x 4 1/4" W, 2 7/8" base  
112 Silver with Gold  
pictured with pole 225WWR



TFCR214165 **NEW**  
6 3/4" L x 4 1/8" W, 2 7/8" base  
840 White with Gold  
Accents  
pictured with pole WWR

# 2" - 2 1/4" wood & resin



**TFCR214170** **NEW**  
glass finial  
3 5/8" L x 4 3/8" W, 2 3/4" base  
740 Smoky Mocha  
pictured with pole 225WS



**TFCR214171** **NEW**  
glass finial  
3 5/8" L x 4 3/8" W, 2 7/8" base  
810 Bronzed Ore  
pictured with pole 225WG

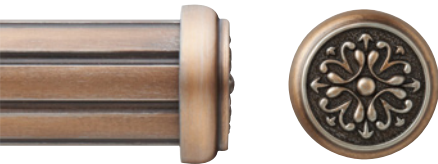

**REC73**  
7/8" L x 2 3/4" W, 2 3/4" base  
760 Rustic Iron  
pictured with pole 225FL



**EC214-1**  
1 3/8" L x 2 7/8" W, 2 7/8" base  
600 Gilded Red  
pictured with pole 225WG



**F214-12**  
2" L x 3" W, 2 7/8" base  
660 Antique White  
pictured with pole 225WR



**F214-2**  
2 1/4" L x 3 1/2" W, 3" base  
610 Cobalt Bronze  
pictured with pole 225WG  
coordinates with rosette ROS-3



**F214-3**  
3 3/4" L x 4" W, 2 7/8" base  
107 Bronze with Gold  
and Gray  
pictured with pole 225FL  
coordinates with rosette ROS-3



**F214-4**  
2 7/8" L x 3 1/2" W, 2 3/4" base  
640 Oil Rubbed Bronze  
pictured with pole 225WS

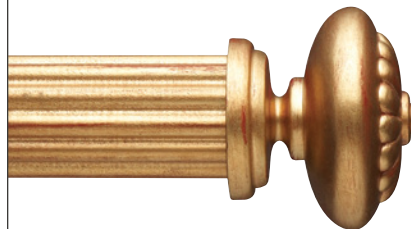

**F214-1**  
3 1/2" L x 4" W, 2 7/8" base  
600 Gilded Red  
pictured with pole 225VWR

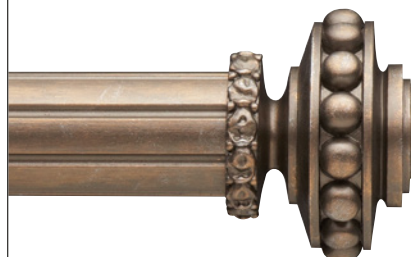

**F214-7**  
3 5/8" L x 4 1/2" W, 3" base  
690 Champagne  
pictured with pole 225FL

2" - 2 1/4"  
wood & resin

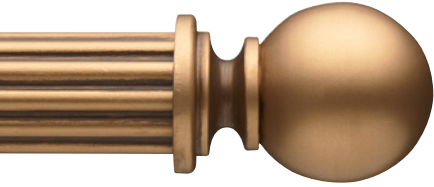

**F214-8**  
4 5/8"L x 3 1/4"W, 2 7/8" base  
680 Aged Gold  
pictured with pole 225WWR



**F214-9**  
4 3/4"L x 4 5/8"W, 3 1/8" base  
710 Tarnished Silver  
pictured with pole 225WG



**RF63**  
3"L x 2 3/4"W, 2 1/2" base  
610 Cobalt Bronze  
pictured with pole 225WS



**F214-10**  
4 1/2"L x 4 1/8"W, 3" base  
620 Weathered Iron  
pictured with pole 225FL

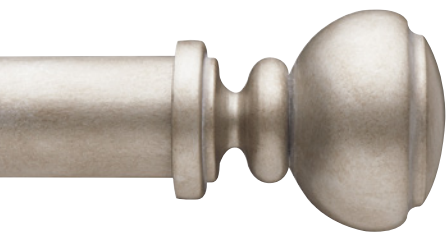

**F214-11**  
4 7/8"L x 4"W, 2 7/8" base  
630 Ash Gray  
pictured with pole 225WS



**F214-6**  
5 1/2"L x 4"W, 2 7/8" base  
670 Espresso  
pictured with pole 225WS



**F214-5**  
7"L x 4 3/4"W, 3" base  
620 Weathered Iron  
pictured with pole 225WWR  
*coordinates with rosette ROS-5*



**F214-14**  
4 7/8"L x 3 1/2"W, 2 7/8" base  
640 Oil Rubbed Bronze  
pictured with pole 225WG



**F214-15S**  
4"L x 4 1/8"W, 2 7/8" base  
155 Antique  
pictured with pole 225WWR  
*coordinates with rosette ROS-1S*



**F214-15C**  
crystal finial  
4"L x 4 1/8"W, 2 7/8" base  
106 Bronze with Gold  
pictured with pole 225WS  
*coordinates with rosette ROS-1C*



**F214-13**  
4"L x 4 1/8"W, 2 7/8" base  
790 Vintage Bronze  
pictured with pole 225WR

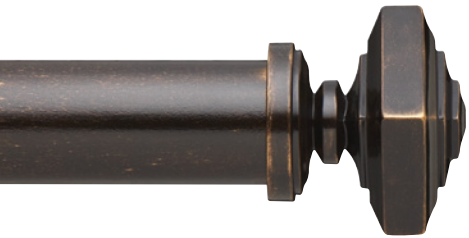

**F214-16S**  
3 5/8"L x 4 1/8"W (3"Sq),  
2 7/8" base  
350G Statuary Bronze  
with Gold  
pictured with pole 225WS  
coordinates with rosette  
ROS-6S



**F214-16C**  
crystal finial  
3 5/8"L x 4 1/8"W (3"Sq),  
2 7/8" base  
630 Ash Gray  
pictured with pole  
225WG  
coordinates with rosette  
ROS-6C



**GB2**  
crystal finial  
5 1/4"L x 3 3/8"W, 2 1/2" base  
250 Platinum  
pictured with pole WWR



**RF1000**  
7 1/4"L x 3"W, 2 3/4" base  
780 Hazelwood  
pictured with pole 225FL



**WW51**  
5 1/2"L x 3 5/8"W, 2 1/2" base  
200 Walnut Gold with  
Gray Accents  
pictured with pole 225WG



**Y10**  
7"L x 3 3/4"W, 2 1/2" base  
107 Bronze with Gold  
and Gray  
pictured with pole  
225WG



**WW207**  
5 7/8"L x 3 3/4"W, 2 1/2" base  
710 Tarnished Silver  
pictured with pole 225WG



**WW60-1**  
2 7/8"L x 3 1/2"W, 3 1/2" base  
660 Antique White  
pictured with pole 225WG



**WW205**  
4"L x 3 1/2"W, 2 1/2" base  
670 Espresso  
pictured with pole 225WS

2" - 2 1/4"  
wood & resin



**R22569**  
6"L x 3 1/2"W, 2 1/2" base  
650 Hickory  
pictured with pole 225WS



**225MC9**  
4 3/8"L x 4 1/4"W, 2 1/2" base  
600 Gilded Red  
pictured with pole 225WG



**WW9**  
3"L x 3 3/8"W, 2 7/8" base  
790 Vintage Bronze  
pictured with pole 225WS



**WW70-1**  
6 1/2"L x 5 1/4"W, 2 1/2" base  
610 Cobalt Bronze  
pictured with pole 225WR  
coordinates with rosette R8



**WW47-1**  
5 3/4"L x 3 1/2"W, 2 1/2" base  
720 Tawny Oak  
pictured with pole 225FL



**WW201**  
5"L x 2 3/4"W, 2 3/4" base  
750 Polished Gold  
pictured with pole  
225WWR



**RF10**  
6 1/2"L x 3 1/2"W, 2 3/4" base  
200 Walnut Gold with Gray  
pictured with pole 2WR



**225MC11**  
4"L x 5"W, 2 1/2" base  
107 Bronze with Gold  
and Gray  
pictured with pole  
225WR  
coordinates with rosette  
RMC11



**GB1**  
glass finial  
5"L x 3"W, 2 1/2" base  
109 Flat Black  
pictured with pole WWR



**WW34-1**  
7"L x 4 1/2"W, 2 3/4" base  
690 Champagne  
pictured with pole 225WR



**WW35**  
6 1/2" L x 4 3/4" W, 2 3/4" base  
690 Champagne  
pictured with pole 225FL



**225MC13**  
3 3/4" L x 4 7/8" W, 2 1/2" base  
640 Oil Rubbed Bronze  
pictured with pole 225VWWR  
*coordinates with rosette RMC13*



**WW251**  
3 3/4" L x 2 3/4" W, 2 3/8" base  
760 Rustic Iron  
pictured with pole 2WG



**WW23**  
5" L x 2 3/4" W, 2 1/4" base  
155 Antique  
pictured with pole VWWR



**WW203**  
5" L x 3 1/4" W, 2 5/8" base  
790 Vintage Bronze  
pictured with pole 225WR



**GB3**  
glass finial  
6" L x 4" W, 2 3/4" base  
320 Pewter  
pictured with pole 225WS



**RD225**  
6" L x 5 1/2" W, 3 1/4" base  
155 Antique  
pictured with pole 225WS

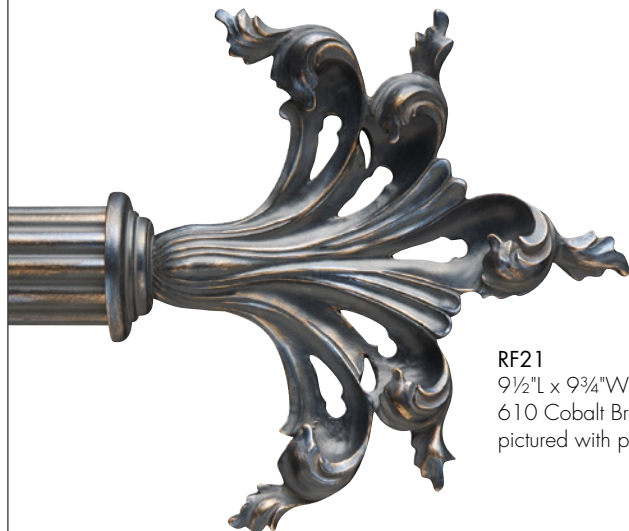

**RF21**  
9 1/2" L x 9 3/4" W, 2 3/4" base  
610 Cobalt Bronze  
pictured with pole 225VWWR



**RF20**  
7 1/4" L x 5" W, 2 1/2" base  
710 Tarnished Silver  
pictured with pole 225WG

# 2" - 2 1/4" wood & resin



**RF64**  
2 5/8" L x 2 3/8" W, 2 1/2" base  
770 Bronze Patina  
pictured with pole VVWF  
coordinates with rosette R64



**EP8**  
5 5/8" L x 3 5/8" W, 2 3/4" base  
610 Cobalt Bronze  
pictured with pole 225WR



**W551**  
wood finial  
5 1/2" L x 3 1/2" W, 2 1/4" base  
240 Walnut  
pictured with pole 225WG



**EP1**  
6" L x 3 1/4" W, 2 1/2" base  
330 Bronze with Black  
pictured with pole 2WG  
coordinates with rosette REP1



**WW77**  
wood finial  
4 5/8" L x 3" W, 3" base  
670 Espresso  
pictured with  
pole 225WS



**2EC**  
wood finial  
1 1/8" L x 3" W, 3" base  
650 Hickory  
pictured with pole VVWR  
fits 2" Dia pole only



**225EC**  
wood finial  
1 1/8" L x 2 3/4" W, 2 3/4" base  
720 Tawny Oak  
pictured with pole 225WS

## decorative 2" & 2 1/4" brackets



**LFB3**  
resin bracket, single  
3 1/2" return, 1" W x 4 5/8" L backplate

**LFB4**  
resin bracket, single  
6" return, 1" W x 4 5/8" L backplate



**DB76**  
resin bracket, single  
3 3/4" return, 1 1/4" W x 8 5/8" L  
backplate



**DB78**  
resin bracket, single  
3 3/4" return, 1 1/4" W x 8 5/8" L  
backplate



**DB80**  
resin bracket, single  
3 1/2" return, 2 1/2" W x 2 7/8" L  
backplate

*Return distance is from wall to center of cradle.  
Resin brackets shown in 810 Bronzed Ore.*

# brackets

2"-2 1/4"  
wood & resin

## 2" brackets



**WWB1**  
wood bracket, single  
3 1/2" return, 1"W x 4 3/4"L backplate

**WWB2**  
wood bracket, single  
6" return, 1"W x 4 3/4"L backplate



**EB24**  
wood bracket, single  
4" return, 2 3/4"Dia backplate

**EB26**  
wood bracket, single  
6 1/2" return, 2 3/4"Dia backplate



**CSB1**  
wood bracket, single  
3 3/4" return, 1"W x 4 3/4"L backplate

**CSB2**  
wood bracket, single  
6" return, 1"W x 4 3/4"L backplate



**TFCS200MIBK** **NEW**  
2" steel inside mount brackets,  
1 1/2"H x 2 3/4"W backplate, 1"Deep,  
1/4" thick backplate per bracket  
(sold in pairs)



**TFCS200MCMBK** **NEW**  
2" steel ceiling mount bracket  
3 1/4"W x 3 3/4"H ceiling plate,  
3 5/8" drop (distance from ceiling to  
bottom of pole)



**TFRC200REL** **NEW**  
2" hinged elbow,  
4 5/8"L, (3 1/4"L each side when bent)  
2 1/8" base

## 2 1/4" brackets



**225WB1**  
wood bracket, single  
3 1/2" return, 1"W x 4 3/4"L backplate

**225WB2**  
wood bracket, single  
6" return, 1"W x 4 3/4"L backplate



**EB2254**  
wood bracket, single  
4" return, 1 7/8"Dia backplate

**EB2256**  
wood bracket, single  
7" return, 1 7/8"Dia backplate



**225WCS1**  
wood bracket, single  
3 1/2" return, 1"W x 3 1/2"L backplate

**225WCS2**  
wood bracket, single  
6" return, 1"W x 3 1/2"L backplate

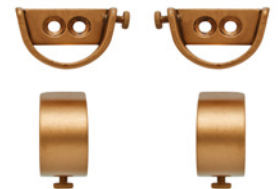

**TFCS214MIBK** **NEW**  
2 1/4" steel inside mount brackets  
1 1/2"H x 2 3/4"W backplate, 1"Deep,  
1/4" thick backplate per bracket  
(sold in pairs)



**TFCS214MCMBK** **NEW**  
2 1/4" steel ceiling mount bracket  
3 1/4"W ceiling plate, 3 3/4"H,  
3 5/8" drop (distance from ceiling to  
bottom of pole)



**TFRC214REL** **NEW**  
2 1/4" hinged elbow,  
5"L, (3 5/8"L each side when bent)  
2 1/8" base

*Return distance is from wall to center of cradle.  
Steel brackets shown in 680 Aged Gold.  
Wood brackets shown in 117 Walnut Gold.*



## 2" & 2 1/4" brackets



**BKT200-214**  
adjustable steel bracket, single  
3 7/8"-5" return, 1"W  
x 3 1/2"L backplate



**WL1**  
steel bracket, single  
3 3/4" return, 3/4"W  
x 2 1/2"L backplate

**WL2**  
steel bracket, single  
6" return, 3/4"W  
x 2 1/2"L backplate



**WL4**  
steel bracket, single  
3 1/2" return, 3/4"W  
x 4 1/4"L backplate

**WL5**  
steel bracket, single  
6" return, 3/4"W  
x 4 1/4"L backplate



**CSWB1**  
steel bracket, single  
3 1/2" return, 3 1/2"W x 1 1/2"H  
backplate

**CSWB2**  
steel bracket, single  
6" return, 3 1/2"W x 1 1/2"H  
backplate



**EB7**  
steel eyelet bracket, single  
3 1/2" return, 1"W x 3 1/2"L  
backplate, eyelet 2 3/8"ID

**EB8**  
steel eyelet bracket, single  
6" return, 1"W x 3 1/2"L  
backplate, eyelet 2 3/8"ID

*Return distance is from wall to center of cradle. Steel brackets shown in 680 Aged Gold.*

## custom solutions: brackets

The Finial Company is known for quality craftsmanship and can create custom brackets to match your job specifications. We can customize bracket dimensions, returns and finish on any pole for a custom fit on every job. For more custom solutions products see our custom brackets section on page 56.



**TBKT**  
custom steel t-bracket, single  
please specify:  
A. return (distance from wall  
to center of cradle)  
B. pole size and profile  
note: 3 1/2"H backplate comes  
standard, unless otherwise  
specified



**DBL1**  
custom steel bracket, double  
please specify:  
A. front pole size and profile  
B. back pole size and profile  
C. rings to be used, if any  
D. front and back returns  
(distance from wall to  
center of cradle)  
note: returns are contingent upon  
which poles and rings are chosen  
3 1/2"H backplate comes  
standard, unless otherwise  
specified



**BL4**  
custom steel ceiling mount  
bracket  
please specify:  
A. drop (distance from  
ceiling to top of pole)  
B. pole size and profile  
C. rings to be used, if any  
note: minimum drop is contingent  
upon which finial and ring are  
chosen.  
2 1/2"W backplate comes  
standard, unless otherwise  
specified



**FBKT**  
custom steel bracket, single  
please specify:  
A. return (distance from wall  
to center of cradle)  
B. pole size and profile  
note: 4 3/4"H backplate may not  
be modified

*Return or drop distance in excess of 8" on any custom bracket will incur additional fees and requires addition of support arm. Custom brackets are shown unfinished, but will be hand painted in your selected Standard Finish (see back cover) or for a custom finish you can send us a finish sample and we'll prepare a strike-off sample for approval (see Retail Price List for custom finish charges).*

# rings

## rings for 2" poles



**WWRG**  
fluted wood ring  
2 3/4" ID, 3 7/8" OD



**SR7**  
smooth steel ring  
2 1/4" ID, 2 3/4" OD



**OVL7**  
smooth oval steel ring  
2 1/4" ID, 2 3/4" OD, 3 1/2" L

## rings for 2" & 2 1/4" poles



**225-RWR**  
fluted wood ring  
2 3/4" ID, 4 1/4" OD



**SR12**  
smooth steel ring  
2 1/2" ID, 3" OD



**OVL12**  
smooth oval steel ring  
2 1/2" ID, 3 1/4" OD, 4" L



**HSR2**  
hammered steel ring  
2 1/2" ID, 3 1/4" OD



**SR5**  
twisted steel ring  
2 1/2" ID, 3" OD



**OVL2**  
hammered oval steel ring  
2 1/2" ID, 3 1/2" OD, 4" L



**DRRG3**  
leafy resin ring  
3" ID, 4 1/2" OD

Wood rings shown in 117 Walnut Gold.  
Steel rings shown in 680 Aged Gold.  
Resin ring shown in 107 Bronze with Gold and Gray.

2" - 2 1/4"  
wood & resin

# poles



**WWR** 2" smooth wood  
**225WS** 2 1/4" smooth wood

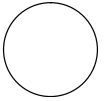

**2WG** 2" grooved wood  
**225WG** 2 1/4" grooved wood

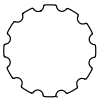

**WWF** 2" fluted wood  
**225FL** 2 1/4" fluted wood

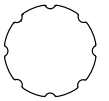

**2WR** 2" reeded wood  
**225WR** 2 1/4" reeded wood



**225WWR** 2 1/4" wide reeded wood

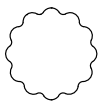

2" and 2 1/4" wood poles are sold in 2 foot increments, 2 foot minimum.  
Poles will be cut to specified length. Fall off will not be saved or shipped.  
Maximum length of all 2" and 2 1/4" wood poles is 192".  
Poles shown in 117 Walnut Gold.

# accessories



- A SBTN**  
steel baton, specify finish  
3/8" Dia  
specify length up to 60"  
**SBTN60**  
specify length up to 96"
- B FBTN**  
fiberglass baton, white  
3/8" Dia  
specify length up to 48"
- C ABTN-36** NEW  
clear acrylic baton  
3/8" Dia, available in 36"
- ABTN-48** NEW  
clear acrylic baton  
3/8" Dia, available in 48"
- D WBTN**  
wood baton, specify finish  
3/8" Dia  
specify length up to 48"
- E EPBTN-1**  
wood baton, specify finish  
3/8" Dia, handle: 6 1/8" L x 1 1/4" Dia  
specify length up to 48"
- F EPBTN-2**  
wood baton, specify finish  
3/8" Dia, handle: 5 3/4" L x 1 1/2" Dia  
specify length up to 48"



MB214 band, R-2 rosette, 225VWG pole, finish 710 Tarnished Silver

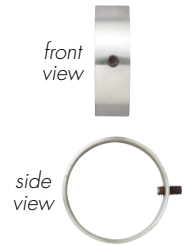

**MB214**  
metal band, attaches any rosette to front of 2 1/4" diameter pole. Use with 2 1/4" pole only. For more information on metal bands, see page 92.



## 3" wood & resin

If you are looking to make a statement, our 3" wood & resin collection offers stately scale in striking designs to cover even the grandest of windows. With six new finial designs to select from, you can create modern to traditional window designs of great distinction.

3"

wood & resin



**TFCR300190** **NEW**  
1 1/4"L x 3 3/4"W, 3 3/4" base  
112 Silver with Gold  
pictured with pole 3GR



**TFCR300192** **NEW**  
1 1/2"L x 3 7/8"W, 3 3/4" base  
110 Flat Black with Gold  
pictured with pole 3GR



**EC300-1**  
1 1/2"L x 3 3/4"W, 3 3/4" base  
670 Espresso  
pictured with pole 3SM



**3EC**  
wood finial  
1 1/8"L x 3 3/4"W, 3 3/4" base  
670 Espresso  
pictured with pole 3SM

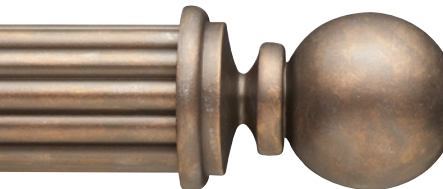

**F300-2**  
5 1/2"L x 3 3/4"W, 3 3/4" base  
690 Champagne  
pictured with pole 3RD



**TFCR300124** **NEW**  
5 3/8"L x 5 1/4"W,  
3 3/4" base  
800 Charred Toasted  
Oak  
pictured with pole 3SM



**TFCR300130** **NEW**  
5 1/4"L x 5 7/8"W, 3 3/4" base  
860 Grayed Brass  
pictured with 3RD pole

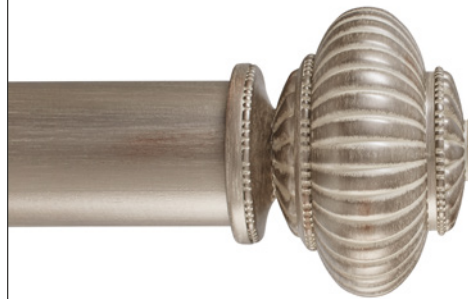

**TFCR300131** **NEW**  
5"L x 6"W, 3 3/4" base  
810 Bronzed Ore  
pictured with pole 3SM



**TFCR300121** **NEW**  
3 3/4"L x 4 1/4"W, 3 5/8" base  
150 Gray with Gold  
pictured with pole 3SM



**F300-3**  
3<sup>7</sup>/<sub>8</sub>"L x 4<sup>1</sup>/<sub>2</sub>"W, 3<sup>3</sup>/<sub>8</sub>" base  
680 Aged Gold  
pictured with pole 3SM



**F300-4C**  
crystal finial  
4<sup>1</sup>/<sub>8</sub>"L x 4<sup>1</sup>/<sub>4</sub>"W, 3<sup>3</sup>/<sub>8</sub>" base  
640 Oil Rubbed Bronze  
pictured with pole 3SM  
*coordinates with rosette ROS-1C*

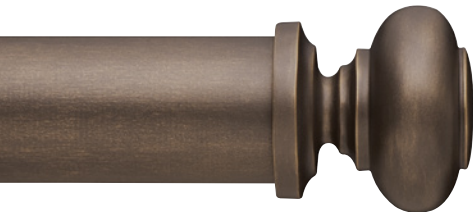

**F300-4S**  
4<sup>1</sup>/<sub>8</sub>"L x 4<sup>1</sup>/<sub>4</sub>"W, 3<sup>3</sup>/<sub>8</sub>" base  
106 Bronze with Gold  
pictured with pole 3SM  
*coordinates with rosette ROS-1S*



**R369**  
8<sup>1</sup>/<sub>2</sub>"L x 5<sup>1</sup>/<sub>4</sub>"W, 3<sup>1</sup>/<sub>2</sub>" base  
320 Pewter  
pictured with pole 3SM



**WW26-1**  
5<sup>1</sup>/<sub>2</sub>"L x 3<sup>3</sup>/<sub>4</sub>"W, 3<sup>3</sup>/<sub>4</sub>" base  
117 Walnut Gold  
pictured with pole 3RD



**3RF10**  
7<sup>1</sup>/<sub>4</sub>"L x 4"W, 3<sup>1</sup>/<sub>4</sub>" base  
760 Rustic Iron  
pictured with pole 3RD



**3RF86**  
7"L x 5<sup>1</sup>/<sub>4</sub>"W, 3<sup>3</sup>/<sub>4</sub>" base  
270 Mahogany Rust  
pictured with pole 3RD

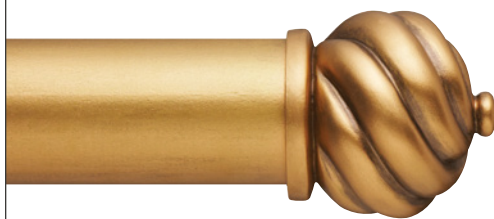

**3R9**  
4"L x 4"W, 3<sup>3</sup>/<sub>8</sub>" base  
750 Polished Gold  
pictured with pole 3SM



**WW75**  
7<sup>1</sup>/<sub>2</sub>"L x 4<sup>1</sup>/<sub>8</sub>"W, 3<sup>3</sup>/<sub>8</sub>" base  
600 Gilded Red  
pictured with pole 3SM



**3RY10**  
8<sup>1</sup>/<sub>4</sub>"L x 4<sup>1</sup>/<sub>2</sub>"W, 4" base  
610 Cobalt Bronze  
pictured with pole 3GR

3"

wood & resin



**3W100**  
8"L x 4½"W, 3½" base  
107 Bronze with  
Gold and Gray  
pictured with pole 3GR



**3RF20**  
11½"L x 7¼"W, 3¾" base  
155 Antique  
pictured with pole 3GR



**F300-1**  
6¼"L x 4¾"W, 3½" base  
650 Hickory  
pictured with pole 3GR



**RD3**  
7¾"L x 7"W, 4" base  
790 Vintage Bronze  
pictured with pole 3GR



**F513**  
7"L x 4"W, 3¼" base  
660 Antique White  
pictured with pole 3GR



**3R35**  
8½"L x 6½"W, 3¾" base  
155 Antique  
pictured with pole 3GR



**3MC11**  
3"L x 5½"W, 3½" base  
700 Graphite  
pictured with pole 3SM  
*coordinates with rosette  
RMC11*

# brackets

3"  
wood & resin



**3LFB1**  
resin bracket, single  
4½" return, 1"W x 4¾"L backplate

**3LFB2**  
resin bracket, single  
6" return, 1"W x 5¼"L backplate



**DB77**  
resin bracket, single  
4¼" return, 2½"W x 2¾"L backplate



**DB79**  
resin bracket, single  
4¼" return, ¾"W x 2¼"L backplate



**3WB1**  
wood bracket, single  
4½" return, 1½"W x 4¾"L backplate

**3WB2**  
wood bracket, single  
6" return, 1½"W x 4¾"L backplate



**3EB4**  
wood bracket, single  
4¼" return, 3½"Dia backplate



**3CSB1**  
wood bracket, single  
4½" return, 1½"W x 3¾"L backplate

**3CSB2**  
wood bracket, single  
6" return, 1½"W x 3¾"L backplate



**3L1**  
steel bracket, single  
3½" return, ¾"W x 2¾"L backplate

**3L2**  
steel bracket, single  
4½" return, ¾"W x 2¾"L backplate

**3L3**  
steel bracket, single  
6" return, ¾"W x 2¾"L backplate



**3L5**  
steel bracket, single  
3¾" return, ¾"W x 3½"L backplate

**3L6**  
steel bracket, single  
6" return, ¾"W x 4¼"L backplate



**3-LELB**  
3" hinged elbow  
4¾"L, (4"L each side when bent),  
3" base

*Return distance is from wall to center of cradle.  
Wood brackets shown in 117 Walnut Gold.  
Steel brackets shown in 680 Aged Gold.  
Resin brackets shown in 810 Bronzed Ore.*



## custom solutions: brackets

The Finial Company is known for quality craftsmanship and can create custom brackets to match your job specifications. We can customize bracket dimensions, returns and finish on any pole for a custom fit on every job. For more custom solutions products see our custom brackets section on page 56.



**TBKT**  
custom steel t-bracket, single  
please specify:  
A. return (distance from wall to center of cradle)  
B. pole size and profile  
note: 3½"H backplate comes standard, unless otherwise specified



**DBL1**  
custom steel bracket, double  
please specify:  
A. front pole size and profile  
B. back pole size and profile  
C. rings to be used, if any  
D. front and back returns (distance from wall to center of cradle)  
note: returns are contingent upon which poles and rings are chosen  
3½"H backplate comes standard, unless otherwise specified



**BL4**  
custom steel ceiling mount bracket  
please specify:  
A. drop (distance from ceiling to top of pole)  
B. pole size and profile  
C. rings to be used, if any  
note: minimum drop is contingent upon which finial and ring are chosen.  
2½"W backplate comes standard, unless otherwise specified



**FBKT**  
custom steel bracket, single  
please specify:  
A. return (distance from wall to center of cradle)  
B. pole size and profile  
note: 4¾"H backplate may not be modified

Return or drop distance in excess of 8" on any custom bracket will incur additional fees and requires addition of support arm. Custom brackets are shown unfinished, but will be hand painted in your selected Standard Finish (back cover) or for a custom finish you can send us a finish sample and we'll prepare a strike-off sample for approval (see Retail Price List for custom finish charges).

## rings



**WRG3**  
fluted wood ring  
3¾"ID, 5¼"OD



**SR11**  
smooth steel ring  
3½"ID, 4"OD



**HSR3**  
hammered steel ring  
3¾"ID, 4¼"OD



**DRRG4**  
leafy resin ring  
3½"ID, 5¼"OD

Wood rings shown in 680 Aged Gold.  
Steel rings shown in 117 Walnut Gold.  
Resin ring shown in 107 Bronze with Gold and Gray.

## poles



3SM 3" smooth wood

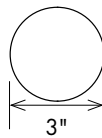

3GR 3" grooved wood

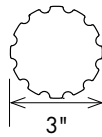

3RD 3" reeded wood

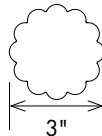

3" wood poles are sold in 2 foot increments, 2 foot minimum. Poles will be cut to specified length. Fall off will not be saved or shipped. Maximum length of all 3" wood poles is 192". Poles shown in 117 Walnut Gold finish.

## accessories



- A SBTN**  
steel baton, specify finish  
3/8"Dia  
specify length up to 60"
- SBTN60**  
specify length up to 96"
- B FBTN**  
fiberglass baton, white  
3/8"Dia  
specify length up to 48"
- C ABTN-36** **NEW**  
clear acrylic baton  
5/8"Dia, available in 36"
- ABTN-48** **NEW**  
clear acrylic baton  
5/8"Dia, available in 48"
- D WBTN**  
wood baton, specify finish  
3/8"Dia  
specify length up to 48"
- E EPBTN-1**  
wood baton, specify finish  
5/8"Dia, handle: 6 1/8"L x 1 1/4"Dia  
specify length up to 48"
- F EPBTN-2**  
wood baton, specify finish  
5/8"Dia, handle: 5 3/4"L x 1 1/2"Dia  
specify length up to 48"



## rosettes

Design is in the details, and The Finial Company offers a wide range of rosettes that can be used to customize the design and functionality of your window treatment. Rosettes can be used as a decorative detail to hold back draperies, added to the front of any standard or custom steel bracket to accentuate the design of your pole or added to a custom tieback arm as the perfect complement to your window design.

# rosettes



**R-RND**  
1 1/4" Dia, steel  
109 Flat Black



**SEC-125**  
1 1/4" Dia, steel  
750 Polished Gold



**EC4**  
1 1/4" Dia, steel  
690 Champagne



**RF4**  
1 1/8" Dia, resin  
680 Aged Gold



**EC3**  
2" Dia, brass  
710 Tarnished Silver



**SEC-2**  
2" Dia, steel  
790 Vintage Bronze



**REC73**  
2 3/4" Dia, resin  
107 Bronze with Gold  
and Gray



**R-16 OH**  
3" Dia, steel  
110 Flat Black with Gold



**R23**  
3 1/2" Dia, steel  
250 Platinum



**R18**  
3 1/2" Dia, resin  
760 Rustic Iron



**R15**  
3 3/4" Dia, resin  
720 Tawny Oak



**RMC13**  
3 5/8" Dia, resin  
740 Smoky Mocha  
*coordinates with finial 225MC13*



**R11**  
4" Dia, resin  
770 Bronze Patina



**REP1**  
4 1/8" Dia, resin  
760 Rustic Iron  
*coordinates with finial EP1*



**R5**  
4 1/4" Dia, resin  
155 Antique



**WR30**  
4 1/4" Dia, wood  
720 Tawny Oak

# rosettes



**R-21**  
2 $\frac{7}{8}$ "Dia, steel  
107 Bronze with  
Gold and Gray



**R24**  
3"Dia, resin  
200 Walnut Gold with  
Gray Accents



**R65**  
3"Dia, resin  
112 Silver with Gold



**R64**  
3"Dia, resin  
106 Bronze with Gold  
*coordinates with finial RF64*



**ROS-1S**  
3 $\frac{3}{4}$ "Dia, resin  
640 Oil Rubbed Bronze  
*coordinates with finials  
F214-15S and F300-4S*



**R-22**  
3 $\frac{3}{4}$ "Dia, steel  
700 Graphite



**ROS-2**  
4"Dia, resin  
610 Cobalt Bronze  
*coordinates with finial F138-6*



**ROS-6C**  
3"Sq, 4 $\frac{1}{4}$ "Diagonal, crystal  
760 Rustic Iron  
*coordinates with finials  
F138-4C and F214-16C*



**ROS-1C**  
3 $\frac{3}{4}$ "Dia, crystal  
670 Espresso  
*coordinates with finial  
F214-15C and F300-4C*



**ROS-6S**  
3"Sq, 4 $\frac{1}{4}$ "Diagonal, resin  
720 Tawny Oak  
*coordinates with finials F138-4S F214-16S*



**RMC11**  
4 $\frac{1}{4}$ "Dia, resin  
107 Bronze with Gold and Gray  
*coordinates with finial 225MC11*



**R-2**  
4 $\frac{1}{2}$ "Dia, resin  
630 Ash Gray



**R73**  
4 $\frac{1}{2}$ "Dia, resin  
610 Cobalt Bronze





**R10**  
4¾" Sq, 7" Diagonal, resin  
117 Walnut Gold



**R-17**  
4¾" Dia, steel  
690 Champagne



**ROS-3**  
5" Dia, resin  
620 Weathered Iron  
*coordinates with finials F214-2 and F214-3*



**R8**  
5" Dia, resin  
710 Tarnished Silver  
*coordinates with finial WW70*



**R-107**  
5¼" Dia, steel  
790 Vintage Bronze



**R101** OH  
5½" Dia, brass  
270 Mahogany Rust with custom gold\*



**ROS-5**  
6" Dia, resin  
730 Rose Gold  
*coordinates with finials F2145 and F300-3*



**ROS-4**  
5¾" Dia, resin  
740 Smoky Mocha

\*Please note: there is an upcharge for this custom finish; please refer to Retail Price List for details.

# rosettes accessories

# metal bands

attach any rosette to the front of a pole

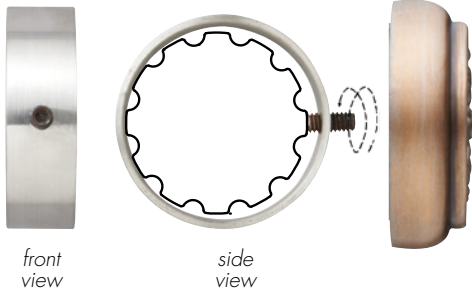

Metal band slides onto pole and is locked in place with set screw. Set screw should be positioned in the front center of pole because it receives the rosette.



### MB100

1" Dia metal band attaches any rosette to front of a 1" Dia pole  
*rosettes sold separately*  
shown: EC3 rosette on RR100 pole, finish 620 Weathered Iron



### MB138

1 3/8" Dia metal band attaches any rosette to front of a 1 3/8" Dia pole  
*rosettes sold separately*  
shown: R24 rosette on WS38 pole, finish 200 Walnut Gold with Gray Accents

hold gathered rod pocket fabric panel in place

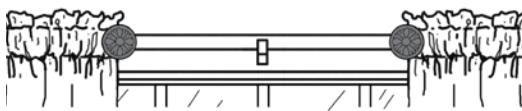

### MB214

2 1/4" Dia metal band attaches any rosette to front of a 2 1/4" Dia pole  
*rosettes sold separately*  
shown: R2 rosette on 225WG pole, finish 710 Tarnished Silver

# rosette posts & brackets



steel tieback post for rosettes  
backplate 1 3/4" Dia

NBL2	2 1/2" projection
NBL4	3 1/2" projection
NBL6	6" projection

OH



wood tieback post for rosettes  
base 1 5/8" Dia

WTBS2	2 1/2" projection
WTBS4	4 1/4" projection
WTBS6	6" projection



steel brackets for rosettes  
backplate 2 1/4" H x 1/2" W

BL2	2 1/2" projection
BL3	3 1/2" projection
BL6	6" projection



**STBA7**  
9½"L x 5" projection  
810 Bronzed Ore



**STB**  
10"L x 4¾"W  
640 Oil Rubbed Bronze



**TTBH-1** OH  
4½"L x 1¼" projection  
790 Vintage Bronze



**TTBH-2** OH  
3½"L x 1¼" projection  
330 Bronze with Black

OH item is available in *Outdoor Hardware*, pages 45-48

## custom solutions: create tiebacks from any finial or rosette

Don't see what your looking for? Just ask our custom shop & we'll make it. For more custom product options, see our Custom Solutions section beginning on page 49.



**TBA**  
6"L back arm x 4½"L front arm,  
4½" projection  
100 Polished Steel\*  
attach finial or rosette of choice to face  
or tip of TBA pictured with L651 finial  
*finial sold separately*



**STBA1**  
8"L back arm x 8"L front arm,  
6½" projection  
610 Cobalt Bronze  
attach finial or rosette of choice  
pictured with R73 rosette  
*rosette sold separately*

*\*please note: there is an upcharge for this custom finish; please refer to Retail Price List for details.*



## standard



**C1**  
20"W x 8¾"H  
155 Antique  
pictured with WW201 finials and 225WWR pole



**C2**  
23¾"W x 9"H  
112 Silver with Gold



**C6**  
26¼"W x 7½"H  
810 Bronzed Ore



**C7**  
16½"W x 7¼"H  
710 Tarnished Silver



**C8**  
27½"W x 15¼"H  
155 Antique

## pole mount slide onto pole



**C3**  
14¾"W x 6"H  
155 Antique  
pictured with RD3 finials in 155 Antique and 3RD pole in 109 Flat Black; *use with 3" pole only*



**C4**  
10⅞"W x 4¼"H  
155 Antique  
pictured with RD225 finials in 155 Antique and 225WR pole in 109 Flat Black; *use with 2¼" pole only*



# traverse systems

light duty traverse	95
heavy duty traverse	98
motorized traverse	102
how to order traverse	108

# HAND-DRAW TRAVERSE FASCIA

cuts for light duty and heavy duty systems

# MOTORIZED TRAVERSE FASCIA

cuts for Somfy Glydea and BTX DC systems

FLAT & SLIM

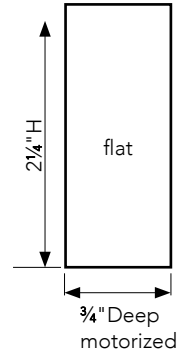
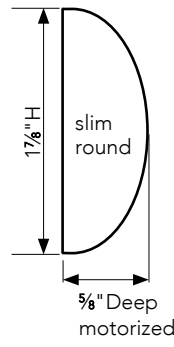
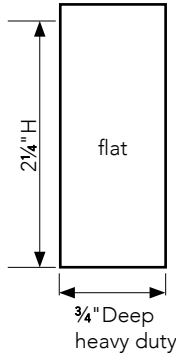
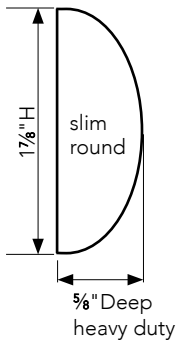

2"

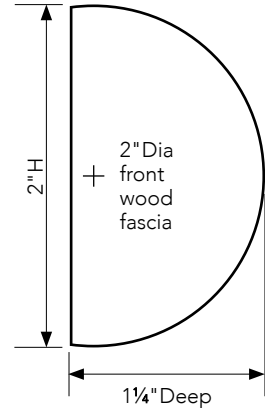
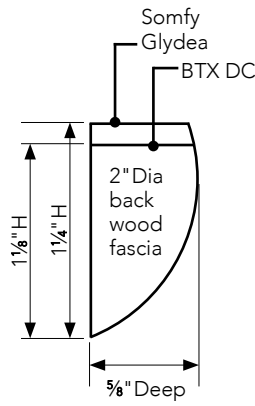
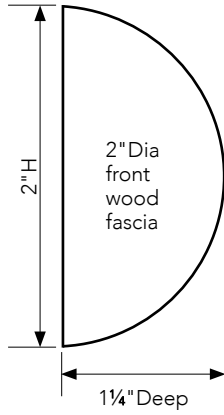
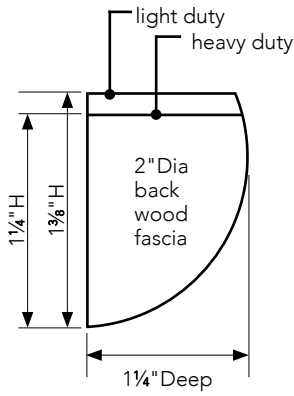

2 1/4"

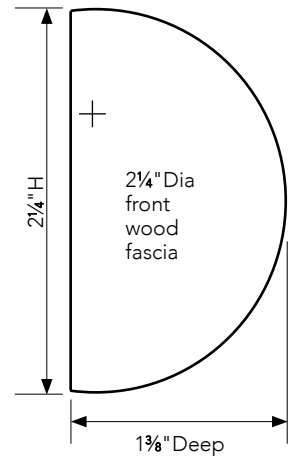
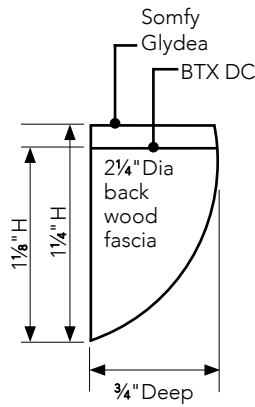
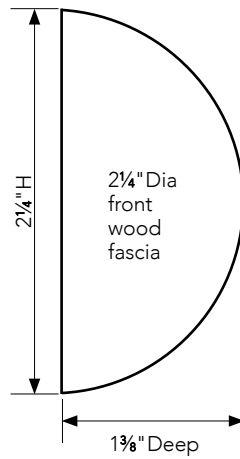
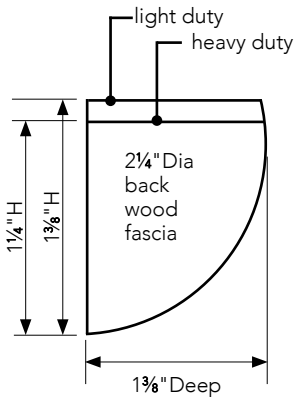

3"

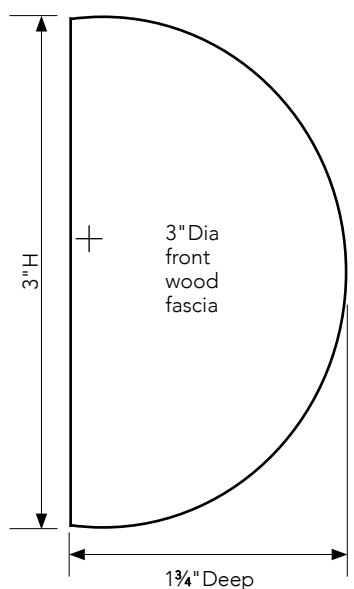
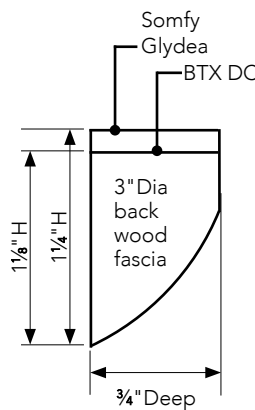
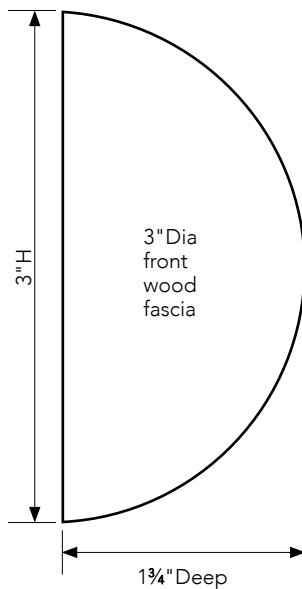
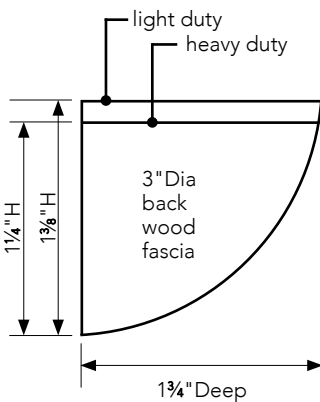



## light duty traverse systems

- Recommended for lightweight fabrics & sheers
- Corded or baton draw
- Available in all profiles for 1 $\frac{7}{8}$ ", 2", 2 $\frac{1}{4}$ " and 3" diameter fascias or without a wood fascia
- Available with or without decorative c-rings for 2", 2 $\frac{1}{4}$ " and 3" diameters
- Finials or mitered returns sold separately
- Pinch Pleat
- Center or one-way draw
- Track, brackets and glides in white or bronze
- Continuous track available up to 20'; continuous fascia available up to 16'; splices and blended fascia can be used to achieve longer lengths

## light duty traverse

CORDED OR BATON DRAW, PINCH PLEAT ONLY.

### Single Traverse System

- coordinates with all fascia profiles or available with no fascia
- standard single brackets are adjustable: 3½" - 4½" return
- 6" return bracket may be substituted at no charge
- custom ceiling mount brackets for systems with fascia available for an additional charge
- batons and finials sold separately
- c-rings available for 2", 2¼" and 3" diameter round fascia systems without mitered returns; sold separately



### Double Traverse System

Back track available with or without wood fascia. Back track shown with fascia and end caps.

- coordinates with all fascia profiles or available with no fascia
- standard double brackets are adjustable: 2½" - 3½" back track and 5½" - 6¼" front track return
- custom ceiling mount brackets for systems with fascia available for an additional charge
- batons and finials sold separately
- c-rings available on front track for 2", 2¼" and 3" diameter round fascia systems without mitered returns; sold separately



### Single or Double Traverse System with Mitered Returns

Back track available with or without wood fascia. Finials and c-rings are not available with this option.

- coordinates with all fascia profiles
- standard single brackets are adjustable: 3½" - 4½" return
- standard double brackets are adjustable: 2½" - 3½" on back track and 5½" - 6¼" on front track return
- custom ceiling mount brackets for systems with fascia available for an additional charge
- batons sold separately
- mitered returns sold separately



### Stationary Front Pole with Back Traverse System

2", 2¼", and 3" wood poles can be used. Shown with custom traverse brackets. Back track available with or without wood fascia. Back track shown with fascia and end caps.

- traverse system coordinates with all 2", 2¼" and 3" round fascia profiles; flat and slim fascia may not be used
- coordinates with 2", 2¼" and 3" poles for stationary front pole
- stationary front pole and TBKT bracket must be ordered separately
- returns need to be specified for front pole and back traversing track
- batons and finials sold separately
- rings are available for front pole and are sold separately



# accessories

# traverse systems



PINCH PLEAT

## BRACKETS AND PINCH PLEAT CARRIERS

quantity per system

	6'	7'	8'	9'	10'	11'	12'	13'	14'	15'	16'
pinch pleat carriers	24	28	32	36	40	44	48	52	56	60	64
brackets	3	3	4	4	4	5	5	5	6	6	6

standard carriers are 4 per foot, standard brackets are 1 every 3-4 feet

## COMPONENT COLORS

	White	Bronze	Antique Gold
Track	•	•	•
Brackets	•	•	•
Glides	•	•	



**HDTB35-L**  
steel traverse bracket, single adjustable 3½" - 4½" return  
2¾"H x 1½"W backplate



**HDTB10-L** NEW  
steel custom bracket, single or double  
4½"H x 1½"W backplate  
specify return up to 10".



**HDTB-L**  
steel traverse bracket, double, can be used for single 6" return adjustable 5½"-6¼" front return adjustable 2½"-3½" back return  
3¾"H x 1½"W backplate



**CMBC-L**  
light duty traverse ceiling mount bracket clip, single  
¼"H x 2⅛"Deep, ⅞"W  
for track-only system without fascia  
*for double ceiling mount installation, install two individual brackets into ceiling*



**CMTB-L**  
steel custom ceiling bracket, single  
2¾"H x 1½"W backplate  
*specify drop: contingent upon whether c-rings are used and which fascia or finials are chosen*  
*for double ceiling mount installation, install two individual brackets into ceiling*



**TBKT214-L**  
• 3½"H x ¾"W backplate, 7⅞" front return and 3" back track return\*  
• use to combine 2" or 2¼" full wood pole with single traverse systems  
• includes traverse ceiling mount bracket attached onto the bottom of the over-bracket  
*poles sold separately*



**TBKT300-L**  
• 3½"H x ¾"W backplate, 8¾" front return and 3" back track return\*  
• use to combine 3" full wood pole with single traverse systems  
• includes traverse ceiling mount bracket attached onto the bottom of the over-bracket  
*poles sold separately*



**pinch pleat master carriers**  
• multi-wheel design for smooth movement  
• corded or baton draw  
• left and right  
• white or bronze



**light duty pinch pleat glide**  
• white or bronze



**225CR**  
wood traverse c-ring  
2½"ID, 4⅞"OD  
*use with 2" or 2¼"D round wood fascia*

**3CR**  
wood traverse c-ring  
3⅞"ID, 5"OD  
*use with 3"D round wood fascia*

\*for custom returns, see page 56



## heavy duty traverse systems

- Recommended for heavier fabrics with lining or treatments mounted over 10' from the floor
- Corded or baton draw
- Available in all profiles for 1<sup>7</sup>/<sub>8</sub>", 2", 2<sup>1</sup>/<sub>4</sub>" and 3" diameter fascias or without a wood fascia
- Finials or mitered returns sold separately
- Pinch Pleat or Ripplefold roller carriers in 60%, 80%, 100% and 120% fullness
- Center or one-way draw
- Track, brackets and glides in white or bronze
- Continuous track available up to 20'; continuous fascia available up to 16'; splices and blended fascia can be used to achieve longer lengths

# heavy duty traverse

CORDED OR BATON DRAW, RIPPLEFOLD OR PINCH PLEAT.

## Single Traverse System

*C-rings are not available with this option.*

- coordinates with all fascia profiles or available with no fascia
- standard single brackets are adjustable: 3 1/2" - 4 1/2" return
- 6" return bracket may be substituted at no charge
- custom ceiling mount brackets for systems with fascia available for an additional charge
- batons and finials sold separately



## Double Traverse System

*Back track available with or without wood fascia. Back track shown with fascia and end caps. C-rings are not available with this option.*

- coordinates with all fascia profiles or available with no fascia
- standard double brackets are adjustable: 2 1/2" - 3 1/2" back track and 5 1/2" - 6 1/4" front track return
- custom ceiling mount brackets for systems with fascia available for an additional charge
- batons and finials sold separately

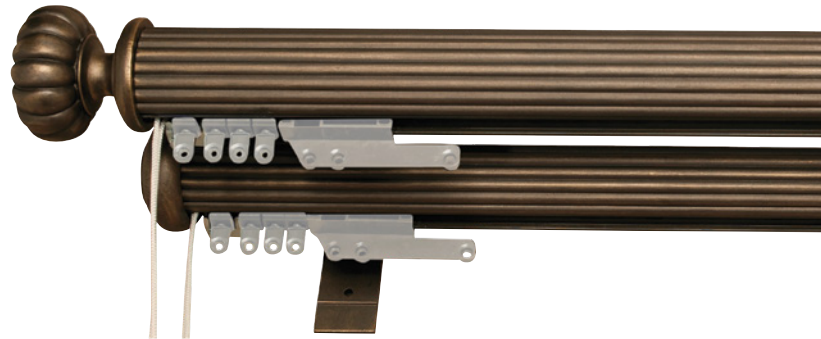

## Single or Double Traverse System with Mitered Returns

*Back track available with or without wood fascia. Finials and c-rings are not available with this option.*

- coordinates with all fascia profiles
- standard single brackets are adjustable: 3 1/2" - 4 1/2" return.
- standard double brackets are adjustable: 2 1/2" - 3 1/2" on back track and 5 1/2" - 6 1/4" on front track return
- custom ceiling mount brackets for systems with fascia available for an additional charge
- batons sold separately
- mitered returns sold separately



## Stationary Front Pole with Back Traverse System

*2", 2 1/4", and 3" wood poles can be used. Shown with custom traverse brackets. Back track available with or without wood fascia. Back track shown with fascia and end caps.*

- traverse system coordinates with all 2", 2 1/4" and 3" round fascia profiles; flat and slim fascia may not be used
- coordinates with 2", 2 1/4" and 3" poles for stationary front pole
- stationary front pole and TBKT bracket must be ordered separately
- returns need to be specified for front pole and back traversing track
- batons and finials sold separately
- rings are available for front pole and are sold separately







PINCH PLEAT



RIPPLEFOLD

available in 60%, 80%, 100% or 120% fullness

## BRACKETS AND PINCH PLEAT CARRIERS

quantity per system

	6'	7'	8'	9'	10'	11'	12'	13'	14'	15'	16'
pinch pleat carriers	24	28	32	36	40	44	48	52	56	60	64
brackets	3	3	4	4	4	5	5	5	6	6	6

standard carriers are 4 per foot, standard brackets are 1 every 3-4 feet

## COMPONENT COLORS

	White	Bronze	Antique Gold
Track	•	•	•
Brackets	•	•	•
Glides	•		



**HDTB35-H**  
steel traverse bracket, single  
adjustable 3½" - 4½"  
return  
2¾"H x 1½"W backplate



**HDTB10-H** NEW  
steel custom bracket, single  
or double  
4½"H x 1½"W backplate  
specify return up to 10".



**HDTB-H**  
steel traverse bracket,  
double, can be used for  
single 6" return  
adjustable 5½"-6¼" front  
return  
adjustable 2½"-3½" back  
return  
3¾"H x 1½"W backplate



**CMBC-H**  
heavy duty traverse ceiling  
mount bracket clip, single  
¾"H x 2¾"Deep, 7/8"W  
for track-only system  
without fascia  
*for double ceiling mount  
installation, install two  
individual brackets  
into ceiling*



**CMTB-H**  
steel custom ceiling  
bracket, single  
2¾"H x 1½"W backplate  
*specify drop: contingent  
upon which fascia or finials  
are chosen*  
*for double ceiling mount  
installation, install two  
individual brackets into  
ceiling*



**TBKT214-H**

- 3½"H x ¾"W backplate, 7/8" front return and 3" back track return\*
- use to combine 2" or 2¼" full wood pole with single traverse systems
- includes traverse ceiling mount bracket attached onto the bottom of the over-bracket

poles sold separately



**TBKT300-H**

- 3½"H x ¾"W backplate, 8¾" front return and 3" back track return\*
- use to combine 3" full wood pole with single traverse systems
- includes traverse ceiling mount bracket attached onto the bottom of the over-bracket

poles sold separately



**fascia clip**

- use to attach fascia to traverse systems; included

\*for custom returns, see page 56



#### pinch pleat master carriers

- stainless steel overlap arms
- multi-wheel design for smooth movement
- corded or baton draw
- left and right
- available in white



#### Ripplefold overlap master carriers

- stainless steel overlap arms with snaps to accept Ripplefold tape
- multi-wheel design for smooth movement
- overlap master carriers come standard unless otherwise specified
- corded or baton draw
- left and right
- available in white



#### Ripplefold butt master carriers

- snaps to accept Ripplefold tape
- multi-wheel design for smooth movement
- butt master carriers do not overlap, allowing some light to filter between draperies on center draw treatments
- butt master carriers must be specified for substitution
- corded or baton draw
- left and right
- available in white



#### heavy duty ball bearing pinch pleat glide

- ball bearing wheel for smooth movement
- available in white



#### Ripplefold glide

- Ripplefold glides with detachable pendants
- 60%, 80%, 100% and 120% fullness available *please specify fullness on order*
- available in white



## motorized traverse systems

- Recommended for windows where optimal function and light control are desired
- Available in all profiles for 1<sup>7</sup>/<sub>8</sub>", 2", 2<sup>1</sup>/<sub>4</sub>" and 3" diameter fascias or without a wood fascia
- Available with BTX and Somfy motors
- Finials or mitered returns purchased separately
- Pinch Pleat or Ripplefold roller carriers in 80%, 100% and 120% fullness
- Center or one-way draw
- Track, brackets and glides in white, bronze or antique gold
- Curved track options available on tracks without fascia
- Continuous track available up to 20' with spliced lengths up to 40'
- Continuous fascia available up to 16'; blended fascia can be used to achieve longer lengths

# motorized traverse systems

# traverse systems

single

double



Single Traverse System with Fascia



Double Traverse System with Fascia



Single Traverse System with Mitered Returns



Double Traverse System with Mitered Returns



Single Traverse System without Fascia



Double Traverse System without Fascia

RIPPLEFOLD OR PINCH PLEAT.

INCLUDED IN SYSTEM: SOMFY® MOTORIZED TRAVERSE TRACK WITH MOTOR AND REMOTE



### Somfy motorized track

- track sold in 1 foot increments, 6' minimum
- maximum continuous length is 20'; spliced lengths up to 36'
- includes one motor, standard remote control 5-channel transmitter per track, and fascia with fascia clips when applicable
- available in antique gold, bronze or white; track finish will complement fascia finish
- end drive gears in white only
- may be ordered with or without fascia
- curved tracks available with minimum 11.8" radius; curving fees apply



### Somfy Glydea® standard remote control transmitter

(multi-channel hand held remote)

- 5¼"H x 1⅝"W
- 1 remote control per track
- 5 channels
- programmable My Position to set your favorite drapery position
- white

### Somfy Glydea® 35e motor

- light duty motor; 1 per track
- maximum drapery weight for light duty motor: 77 lbs
- maximum length for light duty motor: 32'
- 110V Power Supply cord with plug: 120" cord length
- motor can be mounted on left or right for center draw, or top mounted
- return hooks/snaps included; white
- brushed aluminum finish
- 5 year warranty on motor

### Somfy Glydea® 60e motor

- heavy duty motor, 1 per track
- maximum drapery weight for heavy duty motor: 132 lbs
- maximum length for heavy duty motor: 36'
- 110V Power Supply cord with plug: 120" cord length
- motor can be mounted on left or right for center draw, or top mounted
- return hooks/snaps included; white
- brushed aluminum finish
- 5 year warranty on motor



### HDTB35-S

steel traverse bracket, single adjustable 3½" - 4½" return 2¾"H x 1½"W backplate



### HDTB10-S NEW

steel custom bracket, single or double 4½"H x 1½"W backplate specify return up to 10".



### HDTB-S

steel traverse bracket, double, can be used for single 6" return adjustable 5½"-6¼" front return adjustable 2½"-3½" back return 3⅝"H x 1½"W backplate



### CMBC-S

Somfy single ceiling mount bracket

- ½"H x 2"Deep x 1"W
- available in white
- may only be used in systems without fascia
- single bracket; may be substituted in single or double systems



### Somfy fascia clip

• use to attach fascia to traverse systems; included



### CMTB-S

steel custom ceiling bracket, single 2¾"H x 1½"W backplate

specify drop: contingent upon which fascia or finials are chosen

for double ceiling mount installation, install two individual brackets into ceiling



### TBKT214-S

- 3½"H x ¾"W backplate, 7⅞" front return and 3" back track return\*
- use to combine 2" or 2¼" full wood pole with single traverse systems
- includes traverse ceiling mount bracket attached onto the bottom of the over-bracket

poles sold separately

\*for custom returns, see page 56



### TBKT300-S

- 3½"H x ¾"W backplate, 8¾" front return and 3" back track return\*
- use to combine 3" full wood pole with single traverse systems
- includes traverse ceiling mount bracket attached onto the bottom of the over-bracket

poles sold separately

for double ceiling mount installation, install two individual brackets into ceiling



**Somfy pinch pleat or Ripplefold master carrier for center or one-way draw**

- for use with one-way or center draw
- pinch pleat or Ripplefold
- stainless steel



**Somfy Ripplefold butt master carrier for one-way draw**

- for use with one-way opening draperies
- Ripplefold only
- stainless steel

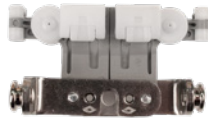

**Somfy Ripplefold butt master carrier for center draw**

- stainless steel arms with snaps to accept Ripplefold tape
- for use with center opening draperies
- butt master carriers do not overlap, allowing some light to filter between draperies on center draw treatments



**Somfy standard pinch pleat glide**

- ball bearing wheel for smooth movement
- included in system; additional glides may be ordered separately
- available in white



**Somfy Ripplefold glide**

- snap accepts Ripplefold tape and swivels to create fold
- 80%, 100% and 120% fullness available
- specify fullness on order
- available in white

## COMPONENT COLORS

	White	Bronze	Antique Gold
Somfy Track	•	•	•
Somfy Brackets	•	•	•
Somfy Glides	•		

## accessories

these additional accessories available for purchase separately



**16 channel RTS remote control transmitter with timer and on-screen display - silver**  
6"H x 2"W  
16 channel remote with programmable timer. Available with wall mount clip.

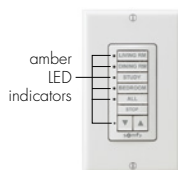

**Somfy wireless RTS wall switches - white**  
4½"H x 2¾"W  
open or close the motorized drapery when you enter or exit a room

- battery-powered, wireless switch
- customizable buttons for selecting window treatments throughout the house
- custom button labels available



**Somfy indoor sun control**  
2¾"Dia x ¾"D  
uses the intensity of the sun to provide automatic control of window coverings in the home. Mounts on window sill or window glass.



**Somfy myLink™**

Control your window coverings with a smartphone or tablet

The myLink™ puts you in control, so you can operate your motorized applications whether you're home or away. On vacation and realized you forgot to close your draperies? Not a problem, with a simple tap of a button in the mylink app, you can close all your window treatments at once.

Free app for iOS and Android



Contact us to learn more about additional Somfy accessories.

# BTX motorized traverse

RIPPLEFOLD OR PINCH PLEAT.

INCLUDED IN SYSTEM: BTX MOTORIZED TRAVERSE TRACK WITH MOTOR AND REMOTE



### BTX motorized track

- track sold in 1 foot increments, 6' minimum
- maximum continuous length is 20'; spliced lengths up to 40'
- includes one motor, BTX transformer, standard remote control 6-channel transmitter per track, and fascia with fascia clips when applicable
- available in antique gold, bronze or white; track finish will complement fascia finish
- may be ordered with or without fascia
- curved tracks available with a minimum 18" radius; curving fees apply

### BTX 120 DC motor

- heavy duty motor, 1 per track
- maximum drapery weight for heavy duty motor: 120 lbs
- tandem motors available for increased weight capacity
- maximum length for heavy duty motor: 40'
- 24V transformer with cord with plug: 120" cord length is standard, longer lengths available
- motor can be mounted on left or right for center draw
- white finish



BTX-DC standard transmitter 6 channel, white



BTX transformer only for BTX-DC-120 motors



**HDTB35-B**  
steel traverse bracket, single  
adjustable 3½" - 4½"  
return  
2¾"H x 1½"W backplate



**HDTB10-B** NEW  
steel custom bracket,  
single or double  
4½"H x 1½"W backplate  
*specify return up to 10".*



**HDTB-B**  
steel traverse bracket,  
double, can be used for  
single 6" return  
adjustable 5½"-6¼" front  
return  
adjustable 2½"-3½" back  
return  
3¾"H x 1½"W backplate



**CMBC-B**  
BTX single ceiling mount  
bracket  
• ½"H x 2"Deep x 1"W  
• available in white  
• may only be used in  
systems without fascia  
• single bracket; may be  
substituted in single or  
double systems

*for double ceiling mount  
installation, install two  
individual brackets into  
ceiling*



**BTX fascia clip**  
• use to attach fascia  
to traverse systems;  
included



**CMTB-B**  
 steel custom ceiling bracket, single  
 2¾"H x 1½"W backplate  
*specify drop: contingent upon which fascia or finials are chosen*  
*for double ceiling mount installation, install two individual brackets into ceiling*



**TBKT214-B**  
 • 3½"H x ¾"W backplate, 7⅞" front return and 3" back track return\*  
 • use to combine 2" or 2¼" full wood pole with single traverse systems  
 • includes traverse ceiling mount bracket attached onto the bottom of the over-bracket  
*poles sold separately*  
*\*for custom returns, see page 56*



**TBKT300-B**  
 • 3½"H x ¾"W backplate, 8¾" front return and 3" back track return\*  
 • use to combine 3" full wood pole with single traverse systems  
 • includes traverse ceiling mount bracket attached onto the bottom of the over-bracket  
*poles sold separately*



**BTX pinch pleat master carrier for center or one-way draw**  
 • stainless steel overlap arms  
 • multiwheel design for smooth movement  
 • standard for pinch pleat treatments  
 • standard right overlap  
 • available in white, bronze or antique gold



**BTX Ripplefold master carrier for one-way draw**  
 • stainless steel snaps to accept Ripplefold tape  
 • multiwheel design for smooth movement  
 • standard for Ripplefold style treatments  
 • standard right overlap  
 • available in white, bronze or antique gold



**BTX Ripplefold master carrier for center draw**  
 • stainless steel snaps to accept Ripplefold tape  
 • butt master carriers do not overlap allowing some light to filter between draperies on center draw treatments  
 • butt master carriers must be specified for substitution  
 • available in white, bronze or antique gold



**BTX standard pinch pleat glide**  
 • ball bearing wheel for smooth movement  
 • included in system; additional glides may be ordered separately  
 • available in white, bronze or antique gold



**BTX Ripplefold glide**  
 • snap accepts Ripplefold tape and swivels to create fold  
 • 80%, 100% and 120% fullness available  
*specify fullness on order*  
 • available in white

## COMPONENT COLORS

	White	Bronze	Antique Gold
BTX Track	•	•	•
BTX Brackets	•	•	•
BTX Glides	•	•	•

*Ripplefold glides available in white only.*

## accessories

these additional accessories available for purchase separately



**BTX double wall switch**  
 one or two channel



**BTX extra cord**  
 • extra cord available up to 20'  
 • cord from motor to wall is 5'

Contact us to learn more about additional BTX accessories.



# traverse systems

how to order the perfect traverse system every time - in 4 easy steps.

## 1 SELECT YOUR TRAVERSE SYSTEM



single traverse  
light duty, heavy duty, motorized



double traverse  
light duty, heavy duty, motorized



stationary front pole and traverse back  
light duty, heavy duty, motorized



single traverse with fascia & c-rings  
light duty only



double traverse with fascia & c-rings  
light duty only

## 2 SELECT A FASCIA DIAMETER AND PROFILE

	1 7/8" Dia	2" Dia	2 1/4" Dia	3" Dia
Slim Round Smooth	•			
Smooth		•	•	•
Grooved		•	•	•
Fluted		•	•	•
Reeded		•	•	•
Wide Reeded			•	
Flat Smooth			•	
No Fascia	•	•	•	•

fascia choice:  no fascia  flush end  mitered returns \_\_\_\_\_  
(specify return. see mitered return charges.)

add finials and select finish: \_\_\_\_\_  
choose finish from list of available finishes to the right or submit a custom finish request.

## 3 SELECT YOUR DRAPERY STYLE



PINCH PLEAT

overlap



RIPPLEFOLD

overlap  butt master

60%  80%  100%  120% fullness

60% fullness not available on Somfy or BTX motorized systems

## 4 COMPLETE YOUR TRAVERSE SPECIFICATIONS

Mount Type:  wall mount  ceiling mount

### COMPONENT COLORS

	hand-draw		motorized	
	light duty	heavy duty	BTX	Somfy
WHITE	•	•	•	•
BRONZE	•		•	
ANTIQUE GOLD			•	

Drapery Draw:

cord draw  add baton: \_\_\_\_\_  
*(cord length: 120" standard) (baton sold separately)*

cord position:

left  
 right

Direction:

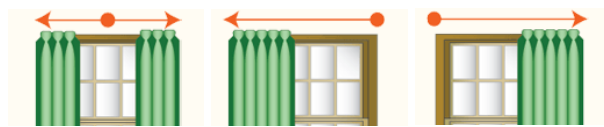

center draw  one-way left  one-way right

Based on your specified finish we supply track and brackets that best match the finish on your fascia. Please refer to the Finish Reference Guide to the right. If you order a custom match finish, please specify your track color.

Components are included in the per foot track price, as listed in the Retail Price List. Components will match the track color when applicable.

Standard carriers are 4 per foot. Standard brackets are 2 end brackets with 1 support bracket for every 3-4 feet of track.

Wood pole profiles available in 1 7/8", 2", 2 1/4" and 3" diameters can be used as fascia.

Spliced fascia will be cut at a 45° angle for an obscure splice upon request.

Spliced fascia can be blended for an additional fee (see Retail Price List). Blended fascia will be properly connected and shipped in one continuous length.

Finish name	Finish code	Recommended track & bracket color
<b>2018 NEW FINISHES</b>		
Charred Toasted Oak	800	Bronze
Bronzed Ore	810	Bronze
Sea Salt Black	820	Bronze
Driftwood	830	White
White with Gold Accents	840	White
Soft Brass	850	Antique Gold
Grayed Brass	860	Bronze
Chalet Gray	870	White
Parchment	880	White
Warm Walnut	890	Bronze
<b>STANDARD FINISHES</b>		
Gilded Red	600	Antique Gold
Cobalt Bronze	610	Bronze
Weathered Iron	620	Bronze
Ash Gray	630	White
Oil Rubbed Bronze	640	Bronze
Hickory	650	Bronze
Antique White	660	White
Espresso	670	Bronze
Aged Gold	680	Antique Gold
Champagne	690	Bronze
Graphite	700	Bronze
Tarnished Silver	710	Bronze
Tawny Oak	720	Antique Gold
Rose Gold	730	Bronze
Smoky Mocha	740	Bronze
Polished Gold	750	Antique Gold
Rustic Iron	760	Antique Gold
Bronze Patina	770	Bronze
Hazelwood	780	Bronze
Vintage Bronze	790	Bronze
Bronze	105	Bronze
Bronze with Gold	106	Bronze
Bronze with Gold and Gray	107	Bronze
Flat Black	109	Bronze
Flat Black with Gold	110	Bronze
Silver with Gold	112	Antique Gold
Walnut Gold	117	Antique Gold
Dark Walnut Gloss with Gold	126	Bronze
Antique Steel	129	Bronze
Antique Steel with Black Highlights	129B	Bronze
Gray with Gold	150	Antique Gold
Antique	155	Antique Gold
Walnut Gold with Gray Accents	200	Antique Gold
Walnut	240	Bronze
Platinum	250	Bronze
Platinum with Black Highlights	250B	Bronze
Mahogany Rust	270	Bronze
Pewter	320	Bronze
Bronze with Black	330	Bronze
Statuary Bronze with Gold	350G	Bronze

# display boards



**TFC18WRDB1** NEW  
 wood & resin  
 display board 1  
 42"H x 24"W x 7"Deep  
 wall mount

**TFC18WRDB1RETRO** NEW  
 wood & resin retro kit 1  
 wall mount



**TFC18WRDB2** NEW  
 wood & resin  
 display board 2  
 42"H x 24"W x 7"Deep  
 wall mount

**TFC18WRDB2RETRO** NEW  
 wood & resin retro kit 2  
 wall mount



**TFC18SDB** NEW  
 steel display board  
 42"H x 24"W x 7"Deep  
 wall mount

**TFC18SDBRETRO** NEW  
 steel retro kit  
 wall mount



**TFC18TTMETAL** NEW  
 metal table top display  
 12¼"H x 20"W x 8"Deep



**TFC18TTMODMETAL** NEW  
 modern metal table top display  
 12¼"H x 20"W x 8"Deep

# how to measure

1. Measure the window width from outside the casing edges. We recommend at least 2" to 4" per side for bracket placement, or finding wall studs on each side of the window in which to drill. Installing the brackets into wall studs is the safest and most secure installation method. Refer to window illustration below.
2. If a window is in the corner, make sure there is enough room to accommodate the finial.
3. The height of the bracket position is determined by the finished drapery length and style. If the treatment is designed to be used with rings, be sure there is proper allowance for the drop of the ring. Refer to the ring illustration below.

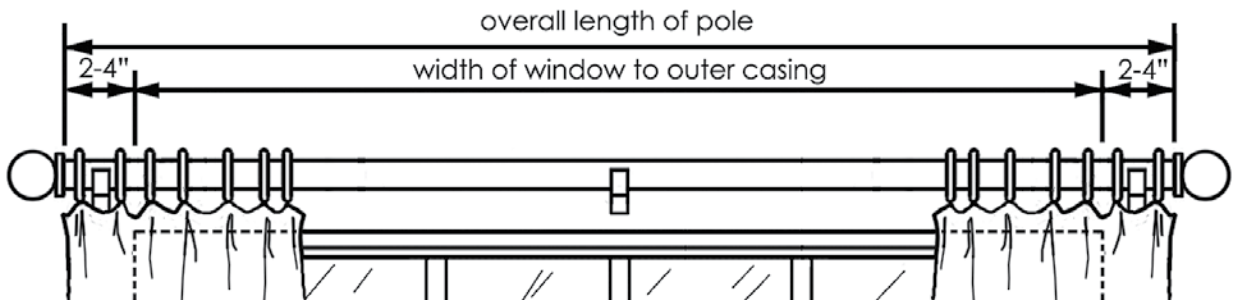

Before you can choose which bracket, ring, and pole diameter to order, you must determine how much room you will have above and to the sides of your window. Some brackets have tall backplates that may either look too large or may not fit into tight spaces.

Things to consider:

1. Does the bracket backplate fit between the top of your window and the ceiling?
2. At what height do you need the pole to be positioned? Will this bracket accommodate your window installation design?
3. If you plan to use rings, what height does the top of your drapery panel need to reach? Will your choice of bracket, ring, and pole diameter accommodate your window treatment design?

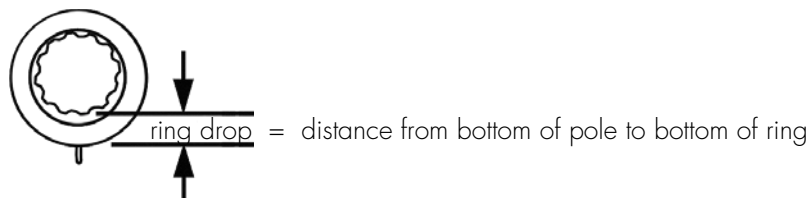

The ring drop determines the height at which the top of the drapery panel will be installed, if using rings. If not using rings, the pole should be installed at a height suitable for a drapery rod pocket or other type of drapery treatment.

*We recommend using a professional installer to measure and install your drapery hardware treatments whenever possible.*

How to measure:

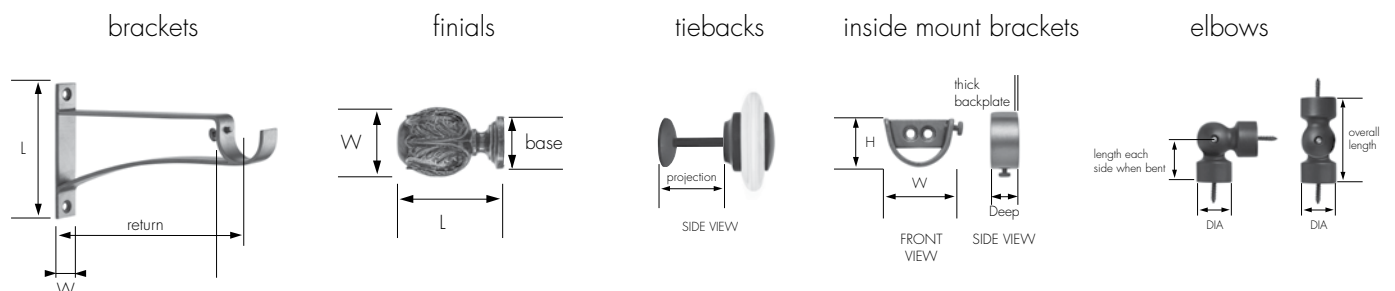

# terms & conditions

## PRICING AND TERMS

Prices found in The Finial Company Retail Price List are our suggested retail prices. Prices are subject to change without notice. Prices are quoted exclusive of freight and packaging. The buyer should always inspect the product upon receipt.

**IMPORTANT:** Please note that your order will be placed with an authorized Finial Company Distributor. While most of the following will generally apply, your distributor may have terms and conditions of sales that will vary from what is stated here.

**Estimated Lead Times:** Purchase orders are processed once they are received by The Finial Company. Incomplete information will delay processing and shipping. The Modern Metal and Metal Collection will ship within 48 hours of the order confirmation, and will ship FOB North Carolina. Painted product (including painted products from the Metal Collection), custom products and traverse systems will ship within 10-15 business days of the order confirmation, and will ship FOB Dallas, TX.

**Rush Orders:** Rush orders are available. An additional 30% charge applies to product and all fees excluding freight and packaging. Rush orders will ship within 5 business days. The 30% rush charge is available for all product except arch rods, bay windows, custom brackets, and mitered returns. If an order is received after 12:00 C.S.T., the next business day will count as the first day of production.

**IMPORTANT:** Please note that rush orders are not always available due to the nature of scheduling in a strictly custom manufacturing environment. Processing time for a rush order is in business days, (excluding holidays) not calendar days.

**Shipping:** Poles over 96" *must* be shipped by common carrier. Please see The Finial Company Retail Price List for applicable Freight and Packaging fees.

## RETURNS, CHANGES & CANCELLATIONS

All orders are considered "custom". No changes or cancellations will be accepted later than 24 hours after order is confirmed. All returns must be authorized by The Finial Company customer service department, and are authorized at our discretion, given the circumstances and nature of each custom order.

## DAMAGED GOODS

Immediately upon receipt, your order should be inspected to ensure that there is no concealed damage from shipping. Claims on damaged merchandise must be made within 15 days of receipt. No claims after 15 days will be accepted. If your order is damaged in shipping, carriers require that *all* packing materials be kept in order for a representative to inspect the goods. Our policy is that we replace damaged product per the original order.

Please note on the bill of lading if there is any possibility of concealed damaged. If shipping through a 3rd party, distributor is responsible for claiming damages and the remakes will be at charge.

## PRODUCT INFORMATION

**Wood poles and traversing rods:** Wood poles and traversing rods are sold in 2 foot increments, 2 foot minimum. We will cut your pole to specification, but we do not save or ship the fall off.

**Steel poles:** All steel poles are sold in 1 foot increments, 2 foot minimum. We will cut to your specification, but we do not save or ship the fall off.

**Support brackets:** We recommend support brackets every 3-4 feet.

**Installation:** Mollie bolts and nail anchors are recommended for all installations, but are not included. We strongly recommend using a professional installer for our hardware.

**Force Majeure:** The Finial Company is not liable for any performance failure that arises from any cause not within its control.

ITEM	PAGE	ITEM	PAGE	ITEM	PAGE
1SQ	31, 50, 53	225MC11	74	CR-SR7	37
2EC	76	225MC13	75	CR-SR12	43, 53
2WG	79	225WB1	77	CR-SR75	23, 53
2VWR	79	225WB2	77	CS1756	42
3CR	97	225WCS1	77	CS17535	42
3CSB1	85	225WCS2	77	CSB1	77
3CSB2	85	225WG	79	CSB2	77
3EB4	85	225WR	79	CSL16	36
3EC	82	225WS	79	CSL125	36
3GR	87	225WWR	79	CSL135	36
3L1	85	387	64	CSWB1	78
3L2	85	1340HB	41	CSWB2	78
3L3	85	4519C	27, 34, 47	DB76	76
3L5	85	A1756	42, 51, 65	DB77	85
3L6	85	A17535	42, 51, 65	DB78	76
3-LELB	85	ABTN-36	9, 13, 17, 24, 31, 38, 44, 67, 80, 87	DB79	85
3LFB1	85			DB80	76
3LFB2	85	ABTN-48	9, 13, 17, 24, 31, 38, 44, 67, 80, 87	DBL1	23, 30, 37, 43, 56, 66, 78, 86
3MC11	84			DRRG3	79
3R9	83	ARBC	59	DRRG4	86
3R35	84	ARBE	59	EB1	22
3RD	87	B1756	42, 48	EB2	22
3RF10	83	B17535	42, 48	EB3	36, 48
3RF20	84	BIRD	21, 28	EB4	36, 48
3RF86	83	BKT050-1	17, 51	EB5	42, 48
3RY10	83	BKT050-2	17	EB6	42, 48
3SM	87	BKT050-3	17, 51	EB7	78
3V100	84	BKT050-4	17	EB8	78
3VWB1	85	BKT075-100	22, 29, 51	EB24	77
3VWB2	85	BKT112-134	42, 51	EB26	77
14R704	35	BKT118-138	36, 51, 65	EB2254	77
38B	65	BKT200-214	78	EB2256	77
38EB3	65	BL2	92	EC3	40, 89
38EB5	65	BL3	92	EC4	16, 19, 89
38EC	64	BL4	23, 30, 37, 43, 56, 66, 78, 86	EC135	26, 33, 47
38FLR	66	BL6	92	EC214-1	71
38ISM	65	Branch with Leaf	21, 28	EC300-1	82
50SRB	17, 50, 52	BTX	106	EP1	76
75ELB	17, 22	C1	94	EP8	76
75HSRB	24, 48, 50, 52	C2	94	EPBTN-1	67, 80, 87
75RD	24, 50, 52	C3	94	EPBTN-2	67, 80, 87
138EC	64	C4	94	F050-1C	16
225CR	97	C6	94	F050-1S	16
225EC	76	C7	94	F050-2C	16
225FL	79	C8	94	F050-2S	16
225-RWVR	79	CMTB	97, 100, 104, 106	F050-3	16
225MC9	74	CR-SR3	30, 37, 53	F138-1	63

# index

ITEM	PAGE	ITEM	PAGE	ITEM	PAGE
F138-2	63	HSR1	37, 48, 66	R8	91
F138-3	63	HSR2	79	R10	91
F138-4C	64	HSR3	86	R11	89
F138-4S	64	HSR175	43, 48	R15	89
F138-5C	63	IM125	36, 48	R-16	47, 89
F138-5S	63	IM175	42, 48	R-17	91
F138-6	64	IMB050-1	17	R18	89
F138-7	63	K657	20, 27, 35	R-21	90
F138-8	63	L16	36, 51	R-22	90
F138-9	63	L26	36, 48	R23	89
F214-1	71	L125	36	R24	90
F214-2	71	L125-SQ	22, 29	R64	90
F214-3	71	L135	36, 51	R65	90
F214-4	71	L135-SQ	22, 29, 51	R73	90
F214-5	72	L235	36, 48	R101	47, 91
F214-6	72	L651	19, 27	R-107	91
F214-7	71	L651FC1	41	R369	83
F214-8	72	L848	21, 27, 47	R22569	74
F214-9	72	L848FC1	41, 47	RD3	84
F214-10	72	L9328	27, 34	RD125	38, 50, 53
F214-11	72	L9328B	27	RD175	44, 50, 53
F214-12	71	L125100	22, 29	RD225	75
F214-13	73	L135100	22, 29, 51	REC73	71, 89
F214-14	72	L885875	20, 27	REP1	89
F214-15C	72	Large Swing Arm with Scroll	57	RF4	33, 89
F214-15S	72	Large Swing Arm without Scroll	57	RF5	63
F214-16C	73	LFB3	76	RF10	74
F214-16S	73	LFB4	76	RF20	75
F300-1	84	LL	57	RF21	75
F300-2	82	LS385	35, 41, 47	RF63	72
F300-3	83	LS385FC1	41	RF64	76
F300-4C	83	MB100	31, 92	RF86	64
F300-4S	83	MB138	67, 92	RF1000	73
F513	84	MB214	80, 92	RMC11	90
FBKT 23, 30, 37, 43, 56, 66, 78, 86		NBL2	47, 92	RMC13	89
FBTN 17, 24, 31, 38, 44, 67, 80, 87		NBL4	47, 92	ROS-1C	90
FC1	40, 58	NBL6	47, 92	ROS-1S	90
Finial Adaptor	58	OVL1	37, 48, 66	ROS-2	90
FSR1	30, 37, 51, 66	OVL2	79	ROS-3	91
FSR2	43, 51	OVL3	37, 66	ROS-4	91
GB1	74	OVL7	43, 79	ROS-5	91
GB2	73	OVL12	79	ROS-6C	90
GB3	75	OVL175	43, 48	ROS-6S	90
GB4	64	PB	21, 28	RR100	31, 48, 52
HDTB	97, 100, 104, 106	PBN	21, 28	RR125	38, 48, 53
HDTB10	97, 100	R-2	90	RR175	44, 48, 53
HDTB35	97, 100, 104, 106	R5	89	R-RND	89

ITEM	PAGE	ITEM	PAGE	ITEM	PAGE
S93	16, 19	SQRG1	23, 30, 51	TFCM118401	7
SBTN	17, 24, 31, 38, 44, 67, 80, 87	SR1	23, 48, 51	TFCM118402	7
SBTN60	17, 24, 31, 38, 44, 67, 80, 87	SR3	30, 37, 48, 51	TFCM118403	8
SCB35	22, 29, 36, 42, 53, 56	SR5	43, 48, 79	TFCM118420	7
SCB6	22, 29, 36, 42, 53, 56	SR7	43, 48, 51, 79	TFCM118420L	7
SCBC	22, 29, 36, 42, 53, 56	SR05	17, 51	TFCM118424	7
SCBCDBL	22, 29, 36, 42, 53, 56	SR11	86	TFCM118426	7
SEC-2	33, 40, 47, 89	SR12	79	TFCM118427	7
SEC-125	19, 26, 33, 47, 89	SR13	66	TFCM118428	7
SELB	42	SRH75	24, 52	TFCM118429	7
SF-1	19, 27	SRT1	31, 52	TFCM118690	6
SF3	19	SRT2	38, 53	TFCM118800	6
SF-4	34, 40	SSA	34	TFCM118801	6
SF19	21, 28, 35	ST2	31, 48, 52	TFCM118802	6
SF35	16	ST3	31, 48, 52	TFCM138002	8
SF36	19	STB	93	TFCM138004	8
SF37	16	STBA1	58, 93	TFCM138006	8
SF45	27, 34	STBA7	93	TFCM138008	8
SF63	34, 40, 47	TBA	58, 93	TFCM138010	8
SF69	19, 26	TBKT	23, 30, 37, 43, 56, 66, 78, 86	TFCM138012	8
SF70	35, 41	TFCM312S	9, 13	TFCM138100	11
SF90	41	TFCM314S	9, 13	TFCM138101	11
SF96	35, 41	TFCM316S	9, 13	TFCM138102	11
SF131	34	TFCM600	5	TFCM138103	11
SF132	27, 35	TFCM600/CL	5	TFCM138104	11
SF133	19, 27, 34	TFCM601	5	TFCM138105	11
SF135	20, 27	TFCM601/CL	5	TFCM138106	11
SF138	35, 40	TFCM602	5	TFCM138107	11
SF140	40	TFCM602/CL	5	TFCM138190	11
SF150	40	TFCM603	5	TFCM138200	12
SF151	40, 47	TFCM604	5	TFCM138201	12
SF158B7	20, 27, 35	TFCM605	5	TFCM138202	13
SF180	19, 26	TFCM606	5	TFCM138204	13
SF192	40	TFCM691	6	TFCM138205	8
SF201	19, 26	TFCM691/CL	6	TFCM138206	13
SF202A	19, 26	TFCM692	6	TFCM138207	8
SF202B	19, 26	TFCM692/CL	6	TFCM138208	13
SF228	41	TFCM990	8	TFCM138210	13
SF230	26, 34	TFCM991	8	TFCM138212	13
SF236	20, 27	TFCM118002	8	TFCM138310	12
SF237	26, 34	TFCM118004	8	TFCM138400	12
SHT1	31, 53	TFCM118006	8	TFCM138400L	12
SL	57	TFCM118008	8	TFCM138401	7, 12
SL3	57	TFCM118010	8	TFCM138402	7, 12
Small Swing Arm	57	TFCM118012	8	TFCM138403	8, 13
SOMFY	104	TFCM118205	8	TFCM138404	12
SQEC	26	TFCM118207	8	TFCM138406	12



# index

ITEM	PAGE	ITEM	PAGE	ITEM	PAGE
TFCM138408	12	TFCR100REL	29	TRT	44, 53
TFCM138420	7	TFCR114REL	36	TTBH-1	48, 93
TFCM138420L	7	TFCR138REL	65	TTBH-2	48, 93
TFCM138424	7	TFCR214REL	77	W551	76
TFCM138426	7	TFCR300121	82	WBTN	67, 80, 87
TFCM138427	7	TFCR300124	82	WG38	67
TFCM138428	7	TFCR300130	82	WL1	78
TFCM138429	7	TFCR300131	82	WL2	78
TFCM138690	6	TFCR300190	82	WL3	78
TFCM138800	6	TFCR300192	82	WL4	78
TFCM138801	6	TFCS034110	16, 19	WL5	78
TFCM138802	6	TFCS100439	29	WNF38	67
TFCR138110	62	TFCS114110	26, 33	WR30	89
TFCR138121	62	TFCS114111	26, 33	WR38	67
TFCR138124	62	TFCS114120	26, 33	WRG3	86
TFCR138125	62	TFCS114170	26, 33	WS38	67
TFCR138126	62	TFCS114171	26, 33	WTBS2	92
TFCR138130	62	TFCS114190	26, 33	WTBS4	92
TFCR138131	62	TFCS134100	40	WTBS6	92
TFCR137164	62	TFCS134190	40	WW9	74
TFCR138165	62	TFCS214150	70	WW23	75
TFCR138170	63	TFCS214151	70	WW26-1	83
TFCR138171	62	TFCS214163	70	WW34-1	74
TFCR138173	62	TFCS100GRDBK	29	WW35	75
TFCR138190	62	TFCS100GRSBK	29	WW47-1	74
TFCR138191	62	TFCS100LADBK	22, 29	WW51	73
TFCR138192	62	TFCS100LAS6BK	22, 29	WW60-1	73
TFCR214110	69	TFCS100LASBK	22, 29	WW70-1	74
TFCR214121	69	TFCS100MCMBK	22, 29	WW75	83
TFCR214122	69	TFCS100MIBK	22, 29	WW77	76
TFCR214123	70	TFCS100SCRI	30, 51	WW190	64
TFCR214124	70	TFCS114GRDBK	36, 51	WW201	74
TFCR214125	70	TFCS114GRSBK	36, 51	WW203	75
TFCR214130	70	TFCS114MCMBK	36	WW205	73
TFCR214131	70	TFCS114MCRI	37, 51	WW207	73
TFCR214163	70	TFCS138GRDBK	53, 65	WW251	75
TFCR214164	70	TFCS138GRSBK	53, 65	WWB1	77
TFCR214165	70	TFCS138MCMBK	65	WWB2	77
TFCR214170	71	TFCS138MIBK	65	WWB3	65
TFCR214171	71	TFCS138WSS6BK	65	WWF	79
TFCR214190	69	TFCS138WSDBK	65	WWR	79
TFCR214191	69	TFCS138WSSBK	65	WWRG	79
TFCR214192	69	TFCS138MCRI	66	Y10	73
TFCR214193	69	TFCS200MCMBK	77		
TFCR214194	69	TFCS200MIBK	77		
TFCR214195	69	TFCS214MIBK	77		
TFCR214196	69	TFCS214MCMBK	77		



800 Charred Toasted Oak



810 Bronzed Ore



820 Sea Salt Black



830 Driftwood



840 White with Gold Accents



850 Soft brass



860 Grayed Brass



870 Chalet Gray



880 Parchment



890 Warm Walnut

*Acceptable variations can occur.  
Please allow 10-15 business days for production. Custom products or finishes may take longer.*

# standard finishes



105 Bronze



150 Gray with Gold

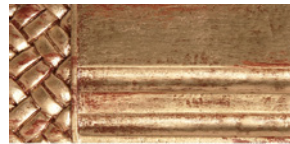

600 Gilded Red



700 Graphite

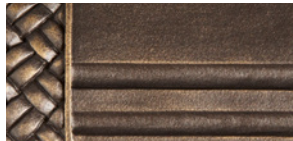

106 Bronze with Gold

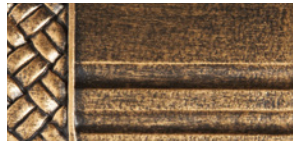

155 Antique



610 Cobalt Bronze

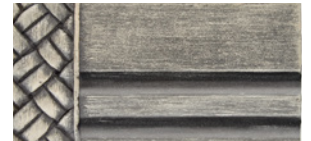

710 Tarnished Silver



107 Bronze with Gold and Gray

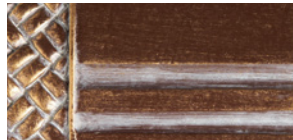

200 Walnut Gold with Gray Accents



620 Weathered Iron



720 Tawny Oak



109 Flat Black

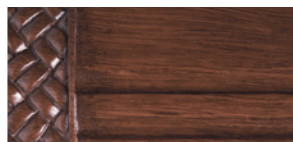

240 Walnut



630 Ash Gray



730 Rose Gold

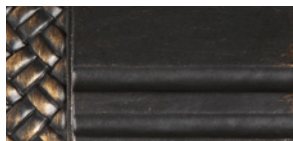

110 Flat Black with Gold

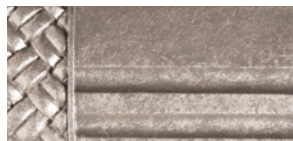

250 Platinum



640 Oil Rubbed Bronze



740 Smoky Mocha



112 Silver with Gold

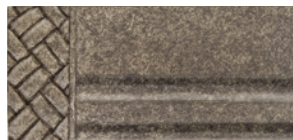

250B Platinum w/Black Highlights

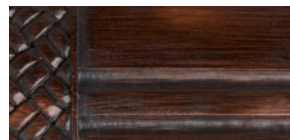

650 Hickory



750 Polished Gold

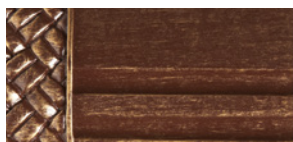

117 Walnut Gold

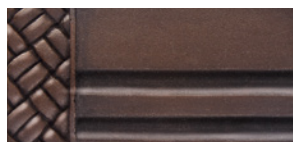

270 Mahogany Rust



660 Antique White



760 Rustic Iron



126 Dark Walnut Gloss with Gold



320 Pewter

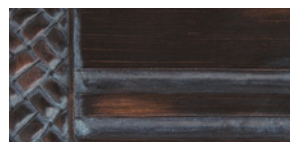

670 Espresso



770 Bronze Patina

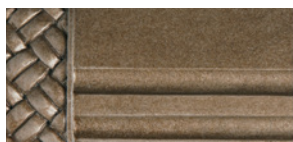

129 Antique Steel

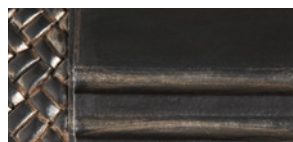

330 Bronze with Black



680 Aged Gold



780 Hazelwood



129B Antique Steel w/Black Highlights

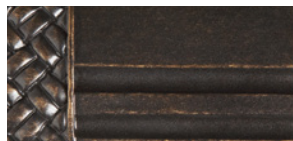

350G Statuary Bronze with Gold

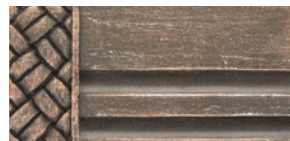

690 Champagne



790 Vintage Bronze

Photographs may not accurately represent the true color of a finish. A finish may show slight variation when painted on different materials, such as wood or steel. For best possible finish match, please refer to the actual sample chip. Please allow 10-15 business days for handpainted finishes. Custom products or finishes may take longer.



## download the catalog

Contents of The Fincial Company catalog and finial styles are fully protected by copyright and must not be reproduced in any manner whatsoever without written permission from The Fincial Company. © Copyright September 2018 by The Fincial Company. All rights reserved. ® Reg. TM, Rowley Company, LLC. Although we have made every effort to ensure accuracy, actual product color may vary slightly from the catalog depiction. Somfy Glydea is a registered trademark of Somfy Systems, Inc.