



TECHNICAL CATALOG FOR PROFESSIONALS
GRAY EDITION

INDEX

TRADITIONAL ENSEMBLES

ADJUSTABLE ROD KITS - 5/8" - 1/2"	25
ADJUSTABLE ROD KITS - 3/4" - 5/8"	26
ADJUSTABLE ROD KITS - 1" - 7/8"	27
ARTFIL KITS	22
BRASS 1"	33
BRASS 1 1/8"	34
BRASS 1 1/2"	35
CURVED RODS	25
METRO 1 1/8"	30
RIVER ROCKS 5/8"	23
SAN FRANCISCO PROGRAM - 5/8" DIAMETER ADJUSTABLE ROD KITS	25
SAN FRANCISCO PROGRAM - 3/4" DIAMETER ADJUSTABLE ROD KITS	26
SIMPLICITE	24
WROUGHT IRON 3/4"	28
WROUGHT IRON 1"	29
WROUGHT IRON 1 1/2"	31

TEKNO ENSEMBLES

EURO-SCOPE	3
KONTUR ALU	5
KONTUR EVO	6
NEXGEN	12
NEXGEN WOOD	14
TEKNO 25	4
TEKNO 40	13
TEKNO 40 WOOD	10
URBAN 3 & 5	8

MEDALLIONS

INFINETTE INSTALLATIONS	32
-------------------------------	----

TEKNO TRACK SYSTEM

PANELLO	16
---------------	----

ACCESSORIES

WAVE DRAPE SYSTEM & KITS	18
--------------------------------	----

TECHNICAL INFORMATION FOR TEKNO PRODUCTS	19 - 21
---	----------------



i Wave Drape is available for **Euro-scope**.
See page 18 for product codes and details.
Euro-scope technical diagrams Page 19.

EURO-SCOPE



HAND DRAW

ENSEMBLE INCLUDES:
RODDING, CLIC GLIDES, FLING WAND AND SUPPORTS.
*EXTRA FLING WAND FOR CENTER OPENING
DRAPES IS SOLD SEPARATELY.*

ONE WAY - CORDED

ENSEMBLE INCLUDES:
RODDING, CLIC GLIDES, PULLEY AND SUPPORTS.

CENTER DRAW - CORDED

ENSEMBLE INCLUDES:
RODDING, CLIC GLIDES, PULLEY AND SUPPORTS.

i Available with predetermined kits.

SUPPORT STYLE



HMP6010
CEILING CLIP SUPPORT



HMP6050
SHORT SUPPORT
1 1/4" projection from wall to rod



HMP6040
WALL SUPPORT
2" to 3" projection



HMP6221
DOUBLE SUPPORT
*1" to 3 1/2" adjustment
between front and back Rods*

Available colors
Rods & supports

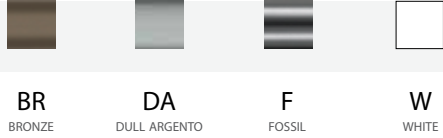

i Rods longer than **106"** will be shipped in two equal lengths.
One piece can be requested.
Extra shipping charges apply.

Rod length	36"	48"	60"	72"	84"	96"	106"	120"	132"	144"	156"	168"	180"
Clic Glides	12	16	20	24	28	32	36	40	44	48	52	56	60
Supports	2	2	2	3	3	3	4	5	5	5	5	7	7
Splice	0	0	0	0	0	0	0	1	1	1	1	1	1

OPTIONAL PRODUCTS



HMP5340
TEKNO CARRIER
*See chart below
for when to use*



HMP5010
CLIC GLIDE SYSTEM
Glides simply clic into rail



HMP7020
END STOP CLIC
*Adjustable end stop
blocks glides to any position on rail*



HMP6030
LONG SUPPORT
3 3/8" to 4 5/8" projection from wall to rod



HMP7360 - 36"
HMP7480 - 48"
HMP7600 - 60"
ALUMINIUM FLING WANDS

AVAILABLE COLORS: BR, DA

COMPATIBILITY

Rod Dimensions	DRAPES WITH : CLIC GLIDES				DRAPES WITH : STANDARD WAVE CARRIER				DRAPES WITH : STANDARD SNAP CARRIER			
	Hand Draw	One Way	Center	Tekno Carriers	Hand Draw	One Way	Center	Tekno Carriers	Hand Draw	One Way	Center	Tekno Carriers
48" - 72"	R	R	R	NR	R	R	R	NR	R	R	R	NR
84" - 96"	R	R	R	S	R	R	R	S	R	R	R	S
106"	R	R	R	S	R	R	R	S	R	R	R	S
120"	R	R	R	S	R	R	R	S	L	L	R	S
132"	L	L	R	S	L	L	R	S	L	L	L	S
144" - 156"	L	L	L	S	L	L	L	S	L	L	L	S
168" - 180"	NR	NR	L	S	NR	NR	NR	S	NA	NA	NA	S

RECOMMENDED LIGHTWEIGHT DRAPES ONLY SUGGESTED FOR HEAVY DRAPES NOT RECOMMENDED NOT AVAILABLE



i Wave Drape is available for Tekno 25. See page 18 for product codes and details. Tekno 25 technical diagrams Page 19.

TEKNO 25 • 1 1/8" DIAMETER



HAND DRAW

ENSEMBLE INCLUDES:
RODDING, CLIC GLIDES, FLING WAND AND SUPPORTS.
EXTRA FLING WAND FOR CENTER OPENING
DRAPES IS SOLD SEPARATELY.

ONE WAY - CORDED

ENSEMBLE INCLUDES:
RODDING, CLIC GLIDES, PULLEY AND SUPPORTS.

CENTER DRAW - CORDED

ENSEMBLE INCLUDES:
RODDING, CLIC GLIDES, PULLEY AND SUPPORTS.

i Available with predetermined kits.

SUPPORT STYLE

C-RINGS, SEE PAGE 11



OPTIONAL PRODUCTS



EXTENDER POST 2" - HFP4027
EXTENDER POST 4" - HFP4047
Extends Tekno wall supports



TEKNO DOUBLE SUPPORT
HTP6228 - 4" SUPPORT
HTP6238 - 6" SUPPORT
Use with ROD ONLY ensembles
C-Rings do not work with Double Support



HFP6168
LATERAL SUPPORT 28
Inside mount -
deduct 1/4" from rod per bracket.
Use with ROD ONLY ensembles up to 72"



HTP6058
TEKNO CEILING SUPPORT 2"
2 1/8" drop from ceiling to rod
Use with ROD ONLY ensembles



HTP6068
TEKNO CEILING SUPPORT 4"
4 1/8" drop from ceiling to rod
Use with ROD ONLY ensembles

i Rods longer than 106" will be shipped in two equal lengths. One piece can be requested. Extra shipping charges apply.

Rod length	36"	48"	60"	72"	84"	96"	106"	120"	132"	144"	156"	168"	180"
Splice	0	0	0	0	0	0	0	1	1	1	1	1	1

i Available colors for finials are identified in RED TEXT.

FINIALS

HFP0048
3 3/8" L x 2 1/8" DIA.
Shown in Antique
A, AS, CH, DW, MR, RS



BALL 28

HFP0188
1" L x 1 3/8" DIA.
Shown in Champagne
A, AS, CH, DW, MR, RS



BARO 28



CAPUCHON 28



EMPIRE

HAP0318
4" L x 2 3/4" DIA.
Shown in Distressed Wood
A, DW, P, RS



EXCENTRIX



LINEA

HAP0468
2 1/8" L x 2 1/8" DIA.
Shown in Maroon
A, AS, CH, DW, MR, RS



OVAL 28



TRANS LU

HAP0328
4 1/4" L x 2 3/8" DIA.
Shown in Pewter
A, DW, P, RS

HFP0548
7/8" L x 1 5/8" DIA.
Shown in Antique Silver
A, AS, CH, DW, MR, RS

HFP0568
4" L x 2 1/8" DIA.
Shown in Antique Silver
A, AS, CH, DW, MR, RS

HFP0538
4" L x 2 1/8" DIA.
Shown in Champagne
A, AS, CH, DW, MR, RS

Available colors
Rods, supports & finials

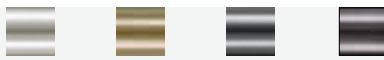

AS ANTIQUE SILVER
CH CHAMPAGNE
DW DISTRESSED WOOD
MR MAROON

Available colors
Certain finials only

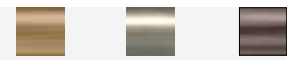

A ANTIQUE
P PEWTER
RS RUSSETTE

i Wave Drape is available for Kontur ALU. See page 18 for product codes and details. Kontur ALU technical diagrams Page 19.

KONTUR ALU



HAND DRAW

ENSEMBLE INCLUDES:
RODDING, CLIC GLIDES, FLING WAND AND SUPPORTS.
EXTRA FLING WAND FOR CENTER OPENING DRAPES IS SOLD SEPARATELY.

ONE WAY - CORDED

ENSEMBLE INCLUDES:
RODDING, CLIC GLIDES, PULLEY AND SUPPORTS.

CENTER DRAW - CORDED

ENSEMBLE INCLUDES:
RODDING, CLIC GLIDES, PULLEY AND SUPPORTS.

i Available with predetermined kits.

SUPPORT STYLE



HTP6010
KONTUR CEILING SUPPORT

AVAILABLE COLORS: AS, CH, DW

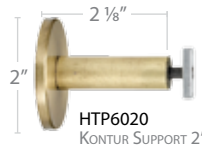

HTP6020
KONTUR SUPPORT 2"



HTP6040
KONTUR SUPPORT 4"

OUVERTURE FINIAL -
DRAPE BUTTS TO WALL ELIMINATING
LIGHT GAPS

OPTIONAL PRODUCTS



HTP6060
KONTUR SUPPORT 6"



HFP4027 - EXTENDER POST 2"
HFP4047 - EXTENDER POST 4"
Extends Tekno wall supports

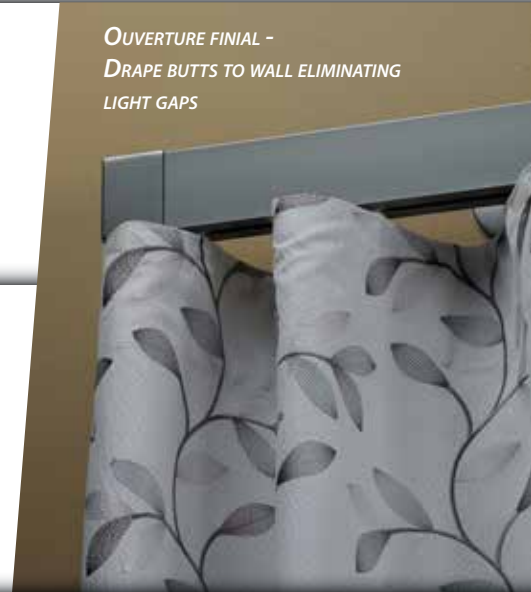

FINIALS



HTP0010
KONTUR ENDCAP



HTP0040
OUVERTURE
Sold in pairs



HTP0050
SEPARÉ
Sold in pairs

RETURNS

QUADRA
HTP0092 - QUADRA 2
HTP0094 - QUADRA 4
HTP0096 - QUADRA 6
*Return determined by size of support;
Kontur Support 2", 4" & 6"
Each return adds 1/4" to rod length.*



ALU RETURN
HTP0082 - ALU RETURN 2
HTP0084 - ALU RETURN 4
HTP0086 - ALU RETURN 6
*Return determined by size of support;
Kontur Support 2", 4" & 6"
Each return adds 1" to rod length.*



Available colors
Rods, supports & finials



AS
ANTIQUE SILVER

DW
DISTRESSED WOOD

OB
OIL RUBBED BRONZE

TA
TAUPE

i Wave Drape is available for **Kontur EVO**. See page 18 for product codes and details. Kontur EVO technical diagrams Page 19.

KONTUR EVO



HAND DRAW

ENSEMBLE INCLUDES: RODDING, CLIC GLIDES, FLING WAND AND SUPPORTS.
EXTRA FLING WAND FOR CENTER OPENING DRAPES IS SOLD SEPARATELY.

ONE WAY - CORDED

ENSEMBLE INCLUDES: RODDING, CLIC GLIDES, PULLEY AND SUPPORTS.

CENTER DRAW - CORDED

ENSEMBLE INCLUDES: RODDING, CLIC GLIDES, PULLEY AND SUPPORTS.

i Available with predetermined kits.

SUPPORT STYLE

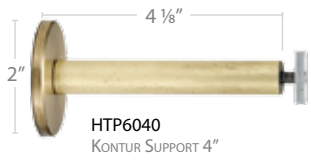

OPTIONAL PRODUCTS

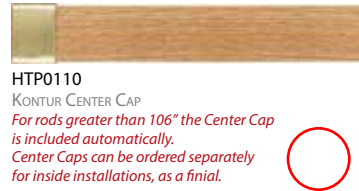
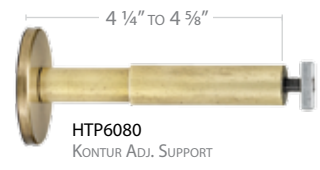

i Rods longer than **106"** will be shipped in two equal lengths. One piece can be requested. Extra shipping charges apply.

Rod length	36"	48"	60"	72"	84"	96"	106"	120"	132"	144"	156"
Hand Draw Splice	0	0	0	0	0	0	0	*1	*1	*1	*1
One Way Splice	0	0	0	0	0	0	0	N/A	N/A	N/A	N/A
Center Draw Splice	0	0	0	0	0	0	0	1	1	1	1

**HAND DRAWN RODS, WHICH ARE SHIPPED IN TWO PIECES, CAN ONLY BE USED AS A CENTER OPENING.*

ROD COLORS



BW
BARN WOOD

CM
CHERRY

E
EBONY

I
IVORY

SM
SMOKE

TR
TRUFFLE

WE
WENGE

FINIALS



SHOWN WITH OUVERTURE FINIAL



RETURNS



QUADRA
HTP0092 - QUADRA 2
HTP0094 - QUADRA 4
HTP0096 - QUADRA 6
*Return determined by size of support;
Kontur Support 2", 4" & 6"
Each return adds 1/4" to rod length.*

 AVAILABLE COLORS: AS, DW



HTP0120
REVERSE CORNER
*Sold as ensembles with choice of support.
See price-list for ordering instructions.*



KONTUR RETURN
HTP0112 - KONTUR RETURN 2
HTP0114 - KONTUR RETURN 4
HTP0116 - KONTUR RETURN 6
*Return determined by size of support;
Kontur Support 2", 4" & 6"
Each return adds 1" to rod length.*

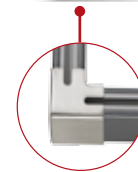

 Available colors
Finials & returns



A
ANTIQUE



CR
CHROME



S
STAINLESS

 Available colors
Quadra returns



AS
ANTIQUE SILVER



DW
DISTRESSED WOOD



Wave Drape is available for Urban 3 & 5.
See page 18 for product codes and details.
Urban 3 & 5 technical diagrams Page 20.

URBAN 3 & URBAN 5



VALANCE ONLY

ENSEMBLE INCLUDES:
VALANCE, 2 RETURNS, & SUPPORTS
CEILING SUPPORTS SOLD SEPARATELY.

HAND DRAW

ENSEMBLE INCLUDES:
VALANCE, RETURNS, CLIC GLIDES, FLING WAND & SUPPORTS.
CEILING SUPPORTS SOLD SEPARATELY.
EXTRA FLING WAND FOR CENTER OPENING DRAPES IS SOLD SEPARATELY.

CORDED SYSTEMS

ENSEMBLE INCLUDES:
VALANCE, RETURNS, CLIC GLIDES, PULLEY & SUPPORTS.
CEILING SUPPORTS SOLD SEPARATELY.

VALANCE ENSEMBLES



URBAN 5 WITH RETURN 3

SHOWN IN DULL ARGENTO (DA)
RETURN SIZE: 3" LENGTH X 5" HEIGHT X 1/4" WIDTH



HUP6030
SUPPORT U-3
2 1/4" interior projection, from wall to valance.

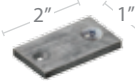

HUP6080
URBAN CEILING SUPPORT
Available with all kits.



URBAN 3 WITH RETURN 3

SHOWN IN BLACK (DW)
RETURN SIZE: 3" LENGTH X 3" HEIGHT X 1/4" WIDTH



URBAN 5 WITH RETURN 5.5

SHOWN IN DULL ARGENTO (DA)
RETURN SIZE: 5 1/2" LENGTH X 5" HEIGHT X 1/4" WIDTH



HUP6050
SUPPORT U-5.5
5 7/8" interior projection, from wall to valance.

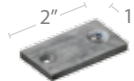

HUP6080
URBAN CEILING SUPPORT
Available with all kits.



URBAN 3 WITH RETURN 5.5

SHOWN IN BLACK (DW)
RETURN SIZE: 5 1/2" LENGTH X 3" HEIGHT X 1/4" WIDTH



URBAN 5 WITH RETURN 7.5

SHOWN IN DULL ARGENTO (DA)
RETURN SIZE: 7 1/2" LENGTH X 5" HEIGHT X 1/4" WIDTH



HUP6070
SUPPORT U-7.5
6 7/8" interior projection, from wall to valance.

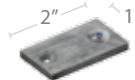

HUP6080
URBAN CEILING SUPPORT
Available with all kits.



URBAN 3 WITH RETURN 7.5

SHOWN IN BLACK (DW)
RETURN SIZE: 7 1/2" LENGTH X 3" HEIGHT X 1/4" WIDTH



Valance and returns are available in two colors: DA, DW



Available colors

Valance: complete list below
Returns: DA, DW

COLORS



AH

ASH

AU

AUTUMN

BD

BEACHWOOD

BC

BÉCHAMEL

CF

CAFÉ

CB

CARBON

DT

DELTA

DU

DUNE

GR

GRAPHITE

LT

LATITUDE

MY

MYSTIQUE

RV

RIVA

SV

SILVA

TB

TIMBER

CV

CANVAS

URBAN COMBINATIONS



SINGLE WAVE - VALANCE ROD



SINGLE WAVE - VALANCE



DOUBLE WAVE



SINGLE PLEATED DRAPE - VALANCE ROD



SINGLE PLEATED DRAPE - VALANCE

WHEN USING URBAN 3, ENSURE PLEATS DO NOT EXTEND BELOW VALANCE.



DOUBLE PLEATED DRAPE



SINGLE SHADE - VALANCE



SHADE + WAVE



SHADE + PLEATED DRAPE

COMPATIBILITY

CONFIGURATIONS	SPECIAL REQUIREMENTS	3" RETURN	5.5" RETURN	7.5" RETURN	CEILING SUPPORT (For all Return lengths)
Single Wave - valance rod	None	Yes	Yes	Best w/ 3 or 5.5" Re.	Yes
Single Wave - valance	Euro/Nexgen Rods	No	Yes	Best w/ 5.5" Return	Yes
Single Pleated Drape - valance rod	None	Yes	Yes	Best w/ 3 or 5.5" Re.	Yes
Single Pleated Drape - valance	Euro/Nexgen Rods	Yes	Yes	Best w/ 3 or 5.5" Re.	Yes
Single Shade Product - valance	1.75" Clearance	Yes (1.75" Clearance)	Yes	Best w/ 5.5" Return	Yes
Double Wave	Euro/Nexgen Rods	No	No	Yes	Yes
Double Pleated Drape	Euro/Nexgen Rods	No	Yes	Best w/ 5.5" Return	Yes
Shade + Wave Product	Verify supports	Yes (1.75" Clearance)	Yes	Best w/ 5.5" Return	Yes
Shade + Pleated Drape	Verify supports	Yes (1.75" Clearance)	Yes	Best w/ 5.5" Return	Yes

TEKNO 40 WOOD • 1 1/2" DIAMETER

i Wave Drape is available for Tekno 40 Wood. See page 18 for product codes and details. Tekno 40 Wood technical diagrams Page 20.

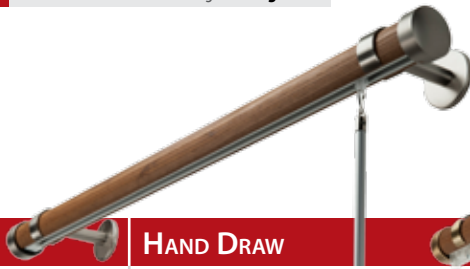

HAND DRAW

ENSEMBLE INCLUDES:
RODDING, CLIC GLIDES, FLING WAND AND SUPPORTS.
EXTRA FLING WAND FOR CENTER OPENING DRAPES IS SOLD SEPARATELY.



ONE WAY - CORDED

ENSEMBLE INCLUDES:
RODDING, CLIC GLIDES, PULLEY AND SUPPORTS.



CENTER DRAW - CORDED

ENSEMBLE INCLUDES:
RODDING, CLIC GLIDES, PULLEY AND SUPPORTS.

i Available with predetermined kits.

SUPPORT STYLE



OPTIONAL PRODUCTS



HFP6164
LATERAL SUPPORT 40
Inside mount - deduct 1/4" from rod per bracket. Use with ROD ONLY ensembles up to 72"



HTP6014
T40 CEILING SUPPORT
Use with ROD ONLY ensembles



HFP4027S - EXTENDER POST 2"
HFP4047S - EXTENDER POST 4"
Extends Tekno wall supports

i Rods longer than 106" will be shipped in two equal lengths. One piece can be requested. Extra shipping charges apply.

Rod length	36"	48"	60"	72"	84"	96"	106"	120"	132"	144"	156"	
Hand Draw Splice	0	0	0	0	0	0	0	*1	*1	*1	*1	<i>*HAND DRAWN RODS WHICH ARE SHIPPED IN TWO PIECES, CAN ONLY BE USED AS A CENTER OPENING.</i>
One Way Splice	0	0	0	0	0	0	0	N/A	N/A	N/A	N/A	
Center Draw Splice	0	0	0	0	0	0	0	1	1	1	1	

ROD & FINIAL COLORS



HTP0014
TEKNO 40 ENDCAP
1/2" length x 1 3/8" diameter

AVAILABLE COLORS: A, CR, S

TORRIFIED WOOD

BRINGING AN AROMATIC FOREST INTO YOUR HOME
CHEMICAL FREE, RICH COLORS & A NATURAL WOOD SMELL
NATURAL KNOTS AND COLOR VARIATIONS MAY APPEAR.



BW
BARN WOOD



E
EBONY



FG
FUDGE



I
IVORY



SM
SMOKE



TR
TRUFFLE



T40
TORRIFIED 40



T80
TORRIFIED 80

SHARED COMPONENTS • TEKNO 25, KONTUR ALU/EVO, URBAN, TEKNO 40 WOOD

i Wave Drape is available for Tekno 25, Kontur ALU/EVO, Urban & Tekno 40 Wood. See page 18 for product codes and details.



HMP5340
TEKNO CARRIER
See chart below for when to use



HMP7020
END STOP CLIC
Adjustable end stop blocks glides at any position on rail



HMP5010
CLIC GLIDE SYSTEM
Glides simply clic into rail



HTP5010
C-RING
Cannot be used with Tekno Double Support

AVAILABLE COLORS:
A, AS, CH, DW, MR, S



HMP7360 - 36"
HMP7480 - 48"
HMP7600 - 60"
ALUMINIUM FLUNG WANDS

AVAILABLE COLORS: BR, DA



HFP7100 - 39"
FUSION FLUNG WAND

AVAILABLE COLORS: A, F, P, RS



Rod length	36"	48"	60"	72"	84"	96"	106"	120"	132"	144"	156"	168"	180"
Clic Glides	12	16	20	24	28	32	36	40	44	48	52	56	60
C-Rings	12	16	20	24	28	32	36	40	44	48	52	56	60
Supports	2	2	2	3	3	3	4	5	5	5	5	7	7

i Rods longer than **106"** will be shipped in two equal lengths. One piece can be requested. Extra shipping charges apply.

i Technical diagrams for Euro-scope Upgrade **page 21**.

EURO-SCOPE UPGRADE



EURO-SCOPE UPGRADE

ENSEMBLE INCLUDES:

RODDING, CARRIERS AND ALL NECESSARY MOUNTING HARDWARE.

Euro-Scope rod hangs below front rod.

Make Euro-scope drape a minimum of 3/4" shorter than front drape.

AVAILABLE COLORS: BR, DA, F, W



TEKNO 25 WITH
EURO-SCOPE UPGRADE



i Tekno Carriers are ***NOT COMPATIBLE** with Kontur EVO.

COMPATIBILITY

Rod Dimensions	DRAPES WITH : CLIC GLIDES				DRAPES WITH : STANDARD WAVE CARRIER				DRAPES WITH : STANDARD SNAP CARRIER			
	Hand Draw	One Way	Center	*Tekno Carriers	Hand Draw	One Way	Center	*Tekno Carriers	Hand Draw	One Way	Center	*Tekno Carriers
48" - 72"	R	R	R	NR	R	R	R	NR	R	R	R	NR
84" - 96"	R	R	R	S	R	R	R	S	R	R	R	S
106"	R	R	R	S	R	R	R	S	R	R	R	S
120"	R	R	R	S	R	R	R	S	L	L	R	S
132"	L	L	R	S	L	L	R	S	L	L	L	S
144" - 156"	L	L	L	S	L	L	L	S	L	L	L	S
168" - 180"	NR	NR	L	S	NR	NR	NR	S	NA	NA	NA	S

RECOMMENDED LIGHTWEIGHT DRAPES ONLY SUGGESTED FOR HEAVY DRAPES NOT RECOMMENDED NOT AVAILABLE

i Wave Drape is available for Nexgen. See page 18 for product codes and details. Nexgen technical diagrams Page 21.

NEXGEN



HAND DRAW

ENSEMBLE INCLUDES:
RODDING, NEXGEN GLIDES, FLING WAND AND SUPPORTS.
EXTRA FLING WAND FOR CENTER OPENING
DRAPES IS SOLD SEPARATELY.

ONE WAY - CORDED

ENSEMBLE INCLUDES:
RODDING, NEXGEN GLIDES, PULLEY AND SUPPORTS.

CENTER DRAW - CORDED

ENSEMBLE INCLUDES:
RODDING, NEXGEN GLIDES, PULLEY AND SUPPORTS.

i Available with predetermined kits.

SUPPORT STYLE



OPTIONAL PRODUCTS



i Rods longer than 106" will be shipped in two equal lengths. One piece can be requested. Extra shipping charges apply.

Rod length	36"	48"	60"	72"	84"	96"	106"	120"	132"	144"	156"	168"	180"
Splice	0	0	0	0	0	0	0	1	1	1	1	1	1

OPTIONAL ENDCAP



Available colors
Rods, supports & endcap



BR
BRONZE

DA
DULL ARGENTO

W
WHITE

DOUBLE ROD



i Wave Drape is available for Tekno 40. See page 18 for product codes and details. Tekno 40 technical diagrams Page 21.

TEKNO 40 • 1 1/2" DIAMETER

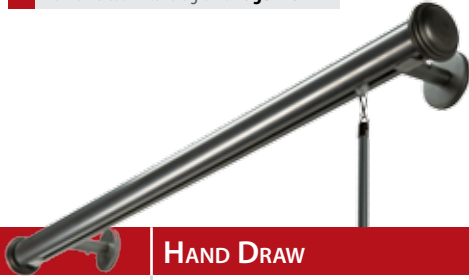

HAND DRAW

ENSEMBLE INCLUDES:
RODDING, NEXGEN GLIDES, FLING WAND AND SUPPORTS.
EXTRA FLING WAND FOR CENTER OPENING DRAPES IS SOLD SEPARATELY.



ONE WAY - CORDED

ENSEMBLE INCLUDES:
RODDING, NEXGEN GLIDES, PULLEY AND SUPPORTS.



CENTER DRAW - CORDED

ENSEMBLE INCLUDES:
RODDING, NEXGEN GLIDES, PULLEY AND SUPPORTS.

i Available with predetermined kits.

SUPPORT STYLE



OPTIONAL PRODUCTS

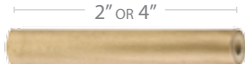

EXTENDER POST 2" - HFP4027
EXTENDER POST 4" - HFP4047
Extends Tekno wall supports



AVAILABLE COLORS: AS, CH, DW



HTP6164
LATERAL SUPPORT 40
Inside mount - deduct 1/4" from rod per bracket. Use with ROD ONLY ensembles up to 72"



FINIALS



ARON

HTP0204
4" L x 2 3/8" DIA.
Shown in Sienna



CENTRALIA

HTP0214
3 5/8" L x 2 3/8" DIA.
Shown in Sandal



ELFIN

HTP0284
4" L x 2 3/4" DIA.
Shown in Maroon



GARIBALDI

HTP0304
3 3/4" L x 2 5/8" DIA.
Shown in Antique Silver



MELROSE

HTP0274
4 3/4" L x 3 1/8" DIA.
Shown in Antique Silver



TAMA 40

HTP0294
4 1/4" L x 2 7/8" DIA.
Shown in Distressed Wood



TAPPO 40

HTP0264
1/2" L x 2 1/8" DIA.
Shown in Sienna



Available colors
Rods, supports & finials



AS
ANTIQUE SILVER



DW
DISTRESSED WOOD



MR
MAROON



SD
SANDAL



SN
SIENNA

i Wave Drape is available for Nexgen Wood. See page 18 for product codes and details. Nexgen Wood technical diagrams Page 21.

NEXGEN WOOD • 2" DIAMETER

COLOR FOR RAIL AND SUPPORTS WILL BE CHOSEN BY THE FACTORY. RAIL IS HIDDEN BEHIND THE DECORATIVE WOOD FACADE.



HAND DRAW

ENSEMBLE INCLUDES: RODDING, NEXGEN GLIDES, FLING WAND AND SUPPORTS.
EXTRA FLING WAND FOR CENTER OPENING
 DRAPES IS SOLD SEPARATELY.

ONE WAY - CORDED

ENSEMBLE INCLUDES: RODDING, NEXGEN GLIDES, PULLEY AND SUPPORTS.

CENTER DRAW - CORDED

ENSEMBLE INCLUDES: RODDING, NEXGEN GLIDES, PULLEY AND SUPPORTS.

SUPPORT STYLE

i Available with predetermined kits.



OPTIONAL PRODUCTS



EXTENDER POST 2" - HFP4027
 EXTENDER POST 4" - HFP4047
 Extends Tekno wall supports



FINIALS



ANTIKA

HTP0026
 5 1/2" L X 3 7/8" DIA.
 Shown in Sandal



DHARMA

HTP0036
 4" L X 3 3/4" DIA.
 Shown in Gold



TAPPO 50

HTP0016
 1" L X 2 3/4" DIA.
 Shown in Distressed Wood



TREVI

HTP0046
 5 3/4" L X 4" DIA.
 Shown in Antique Silver

Available colors
 Finials

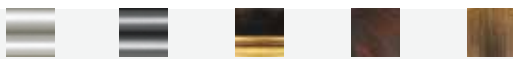

AS ANTIQUE SILVER DW DISTRESSED WOOD GL GOLD MH MAHOGANY SD SANDAL

Available colors
 Wood rods

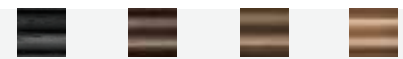

DW DISTRESSED WOOD WE WENGE FG FUDGE M MOCHA

SHARED COMPONENTS • NEXGEN, TEKNO 40, NEXGEN WOOD

i Wave Drape is available for Nexgen, Tekno 40, Nexgen Wood. See page 18 for product codes and details.



HMP5020
BALL BEARING CARRIER



HMP5011
NEXGEN GLIDE



HMP7360 - 36"
HMP7480 - 48"
HMP7600 - 60"
ALUMINIUM FLING WANDS

AVAILABLE COLORS: BR, DA



HFP7100 - 39"
FUSION FLING WAND

AVAILABLE COLORS: A, F, P, RS

i Rods longer than 106" will be shipped in two equal lengths. One piece can be requested. Extra shipping charges apply.

Rod length	36"	48"	60"	72"	84"	96"	106"	120"	132"	144"	156"	168"	180"
Nexgen Glides	12	16	20	24	28	32	36	40	44	48	52	56	60
Supports	2	2	2	3	3	3	4	5	5	5	5	7	7
Splice	0	0	0	0	0	0	0	1	1	1	1	1	1

i Technical diagrams for Euro-scope Upgrade page 21.

EURO-SCOPE UPGRADE



EURO-SCOPE UPGRADE

ENSEMBLE INCLUDES:

RODDING, CARRIERS AND ALL NECESSARY MOUNTING HARDWARE.

Euro-Scope rod hangs below front rod.

Make Euro-scope drape a minimum of 3/4" shorter than front drape.

AVAILABLE COLORS: BR, DA, F, W



STANDARD
INSTALLATION



EURO-SCOPE
UPGRADE



TEKNO 25 WITH
EURO-SCOPE UPGRADE

COMPATIBILITY

Rod Dimensions	DRAPES WITH : NEXGEN GLIDES				DRAPES WITH : STANDARD WAVE CARRIER				DRAPES WITH : STANDARD SNAP CARRIER			
	Hand Draw	One Way	Center	Tekno Carriers	Hand Draw	One Way	Center	Tekno Carriers	Hand Draw	One Way	Center	Tekno Carriers
48" - 72"	R	R	R	NR	R	R	R	NR	R	R	R	NR
84" - 96"	R	R	R	S	R	R	R	S	R	R	R	S
106"	R	R	R	S	R	R	R	S	R	R	R	S
120"	R	R	R	S	R	R	R	S	L	L	R	S
132"	L	L	R	S	L	L	R	S	L	L	L	S
144" - 156"	L	L	L	S	L	L	L	S	L	L	L	S
168" - 180"	NR	NR	L	S	NR	NR	NR	S	NA	NA	NA	S

RECOMMENDED LIGHTWEIGHT DRAPES ONLY SUGGESTED FOR HEAVY DRAPES NOT RECOMMENDED NOT AVAILABLE



Euro-Scope & Tekno 25 technical diagrams **Page 21.**
Refer to **Double Support** installation.

PANELLO • PANEL TRACKS



EURO-SCOPE

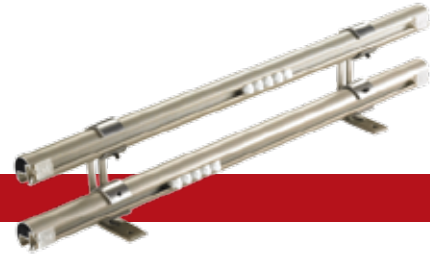

TEKNO 25



Finial selection will automatically include caps for back rod unless otherwise specified.

TEKNO 25 FINIALS



CAP 28

HFP0058
7/8" L x 1 3/8" DIA.
Shown in Antique Silver



BALL 28

HFP0048
3 3/8" L x 2 3/8" DIA.
Shown in Marron



OVAL 28

HFP0468
2 1/8" L x 2 1/8" DIA.
Shown in Champagne



Available colors
Euro-Scope rods



BR
BRONZE



DA
DULL ARGENTO



W
WHITE



Available colors
Tekno 25 finials & rods



AS
ANTIQUE SILVER



CH
CHAMPAGNE



DW
DISTRESSED WOOD



MR
MAROON

OPTIONAL PRODUCTS



HMP7360 - 36"
HMP7480 - 48"
HMP7600 - 60"
ALUMINIUM FLING WANDS



AVAILABLE COLORS: BR, DA



PANELLO • PANEL TRACKS

To create your customized panel track system:

1 Choose track width, 2 Choose panel width, 3 Choose quantity of panels (Refer to price list for tabulation and codes.)



The flexibility of the dual-track panel system offers numerous stacking possibilities depending on changing sunlight conditions throughout the day. (It is not necessary to specify stacking preferences when ordering)

PANEL GLIDERS

Panello Panel Tracks offer two ways to attach your fabric.

Custom Panel Gliders & Hook and Loop Panel Gliders.

- Custom Panel Gliders** allow your fabric to slide onto the hanger. Make the rod pocket a minimum of 1".
- Hook & Loop Panel Gliders** allow for quick placement and removal of fabric for cleaning.

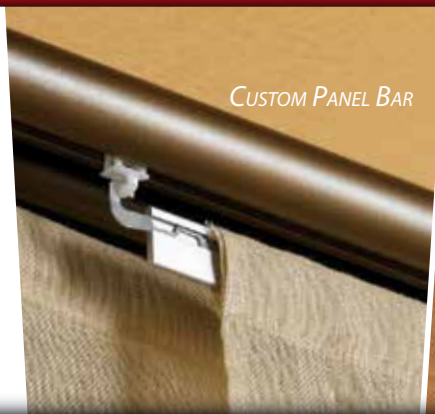

STANDARD KITS

Standard kits are easy. Just add fabric!

COMES ONLY WITH A STANDARD PANEL BAR, 12" OR 24".

- Make the rod pocket minimum of 1".



12" PANEL-TRACK

ENSEMBLE INCLUDES:
DUAL-TRACK RAIL SYSTEM, 2 CAPS FOR BACK ROD (AVAILABLE WITH TEKNO 25),
MOUNTING RAIL SUPPORTS, PANEL BARS, BALLAST BOTTOM BARS, STANDARD 36" FLING WAND
FINIALS & EXTRA FLING WAND FOR CENTER OPENING DRAPES IS SOLD SEPARATELY.

Track Width (Up To)	28" - 32"	42"	52"	62"	72"	84"	96"	102"
No. of Panels	3	4	5	6	7	8	9	10
No. of Supports	2	2	2	3	3	3	3	4
Splice	0	0	0	0	0	0	0	0
Panel Overlap	3" - 1"	4" - 1"	4" - 1"	3" - 1"	3" - 1"	3" - 1"	3" - 1"	2 1/2" - 1 1/2"
Stackback Width	14"	15"	16"	17"	18"	19"	20"	21"

- NUMBER OF INCHES EACH PANEL OVERLAPS ONTO THE NEXT, VARIES ACCORDING TO TRACK LENGTH AND NUMBER OF PANELS.
- WIDTH OF ALL PANELS WHEN COMPLETELY STACKED TOGETHER.



24" PANEL-TRACK

ENSEMBLE INCLUDES:
DUAL-TRACK RAIL SYSTEM, 2 CAPS FOR BACK ROD (AVAILABLE WITH TEKNO 25),
MOUNTING RAIL SUPPORTS, PANEL BARS, BALLAST BOTTOM BARS, STANDARD 36" FLING WAND
FINIALS & EXTRA FLING WAND FOR CENTER OPENING DRAPES IS SOLD SEPARATELY.

Track Width (Up To)	57" - 69"	91"	114"	132"	154"
No. of Panels	3	4	5	6	7
No. of Supports	3	3	3	5	5
Splice	0	0	1 splice (106"+)	1	1
Panel Overlap	7" - 1"	8" - 1"	6 1/2" - 1"	5 1/2" - 1"	5 1/2" - 1"
Stackback Width	26"	27"	28"	29"	30"

- NUMBER OF INCHES EACH PANEL OVERLAPS ONTO THE NEXT, VARIES ACCORDING TO TRACK LENGTH AND NUMBER OF PANELS.
- WIDTH OF ALL PANELS WHEN COMPLETELY STACKED TOGETHER.



WAVE DRAPE • TEKNO WAVE, STANDARD WAVE, TEKNO SNAP & EXTENDED WAVE SYSTEMS

Wave Drape carriers use a new hook system as opposed to the traditional snaps.

- Wave Hooks allow for more flexibility and ease of use.
- Multiple fullness: 1.8 to 2.7 fullness.
- Easy installation, no force required to place hooks.
- Change hook placements quickly after drape is installed.
- Drapes can be washed even while hooks are installed.



WAVE TAPE

SNAP TAPE

TAPE & CARRIERS



HMP7080
WAVE TAPE
Hooks not included



HMP5060
STANDARD WAVE CARRIER
Hooks included



HMP5330
TEKNO WAVE CARRIER
Hooks included



HMP7070
SNAP TAPE



HMP5200
STANDARD SNAP CARRIER
100% fullness



HMP5310
TEKNO SNAP CARRIER
100% fullness

OPTIONAL PRODUCTS



HMP5180
STANDARD WAVE CARRIER 80%
Use to reduce stack back
Hooks included



HMP5380
TEKNO WAVE CARRIER 80%
Use to reduce stack back
Hooks included



HMP5090
TEKNO WAVE HOOK

i Extended Wave is only available with Tekno products.

An extended Wave with wider, shallow folds.
ALLOWS SHOWCASING OF
LARGE SCALE FABRIC PATTERNS & PRINTS.

EXTENDED WAVE USES A UNIQUE SYSTEM OF ACTIVE, INACTIVE CARRIERS, ELIMINATING UNPROFESSIONAL SPACER CORD SAGGING.

EXTENDED WAVE

STANDARD WAVE



EXTENDED WAVE



AVAILABILITY CHART

	EURO-SCOPE, TEKNO 25, TEKNO 40 WOOD, KONTUR ALU, URBAN 3 & 5		KONTUR EVO		TEKNO 40, NEXGEN, NEXGEN WOOD	
	Hand Draw	Corded	Hand Draw	Corded	Hand Draw	*Corded
Standard Wave Carrier	Y	Y	Y	N	Y	Y
Tekno Wave Carrier	Y	Y	N	N	Y	Y
Snap Carrier	Y	Y	Y	N	Y	Y
Tekno Snap Carrier	Y	Y	N	N	Y	Y
Extended Wave	Y	Y	N	N	N	N

*NEXGEN CORDED TRACKS: MASTER CARRIERS WILL BE WITH A REGULAR FLAT OVERLAP.

TEKNO CARRIERS

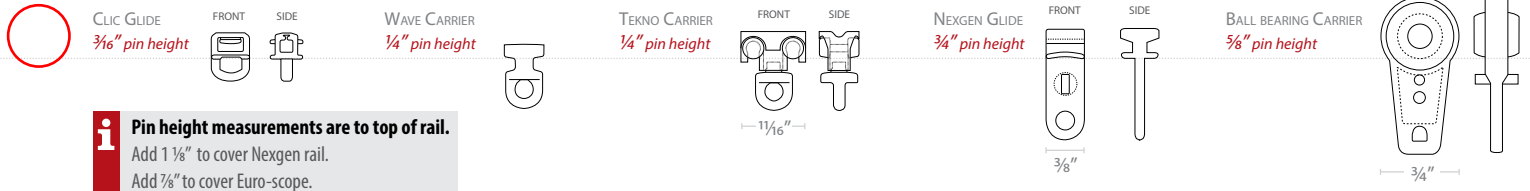

EURO-SCOPE

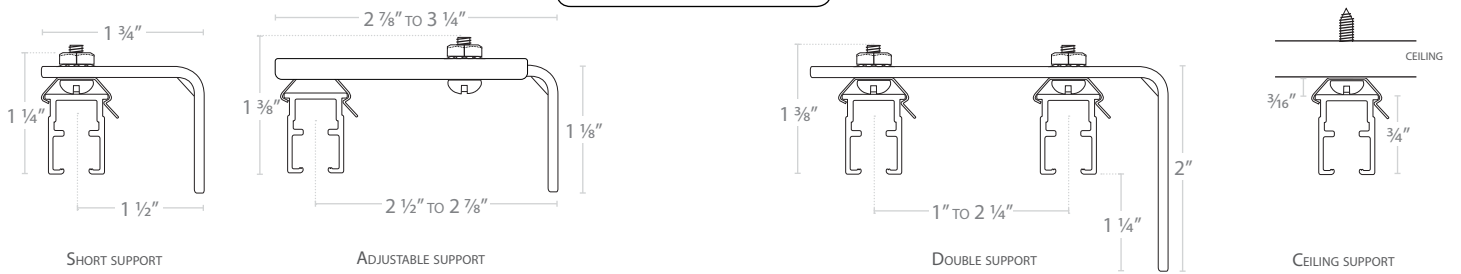

TEKNO 25

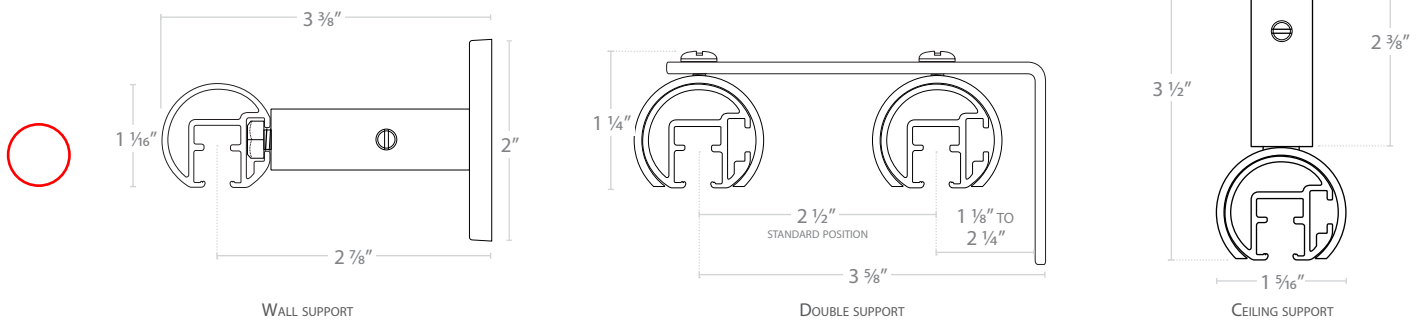

KONTUR ALU & EVO

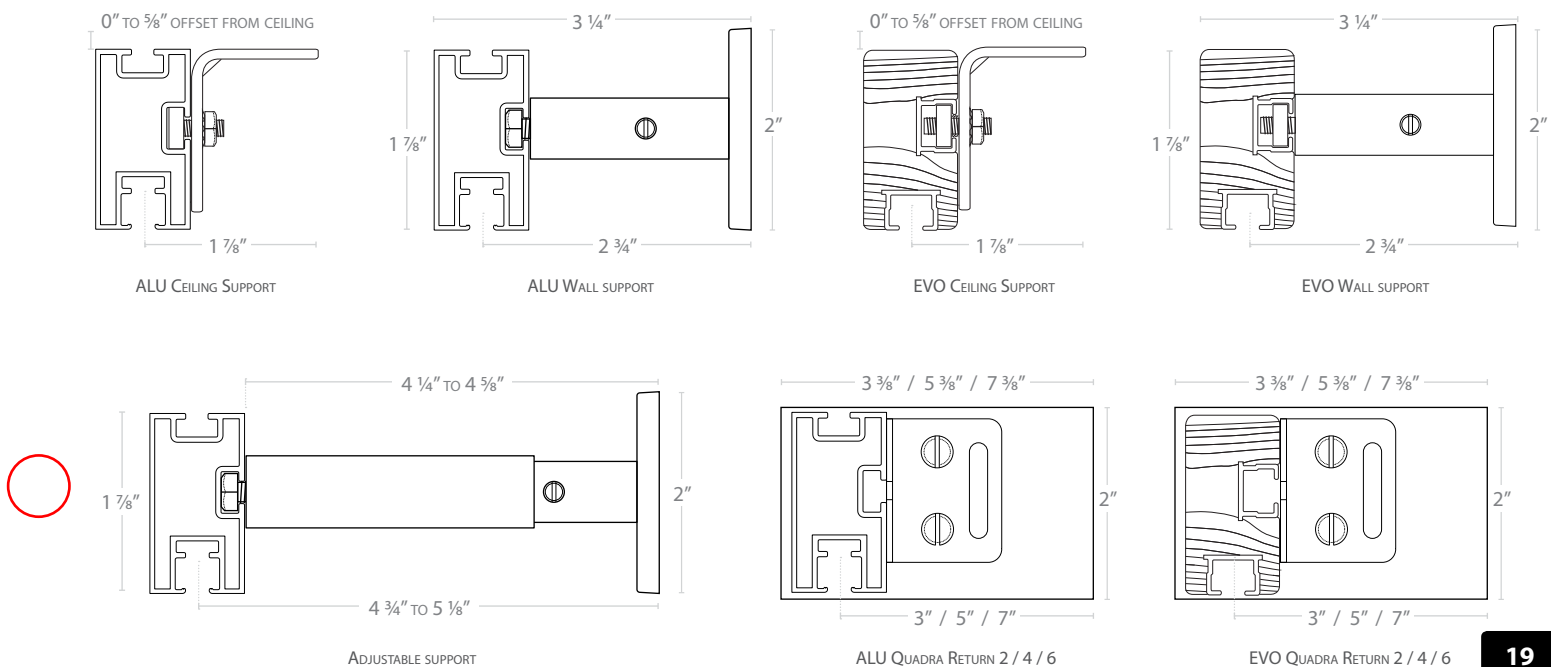

URBAN 3 & 5

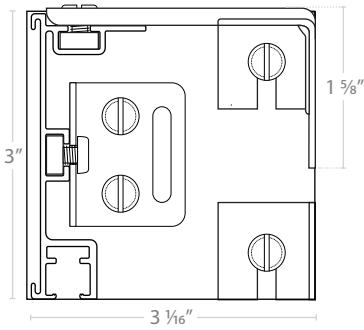

URBAN 3 RETURN 3
Showing all hardware

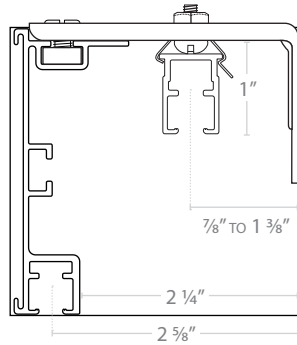

URBAN 3 RETURN 3
With Euro-Scope upgrade

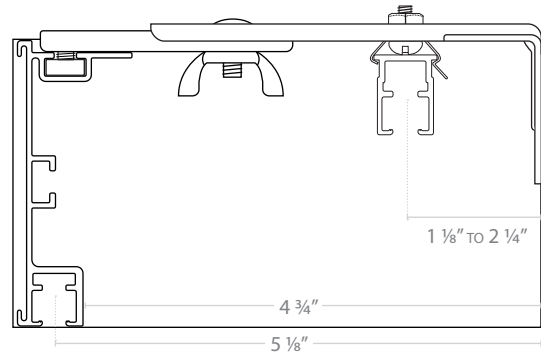

URBAN 3 - RETURN 5.5
With Euro-Scope upgrade

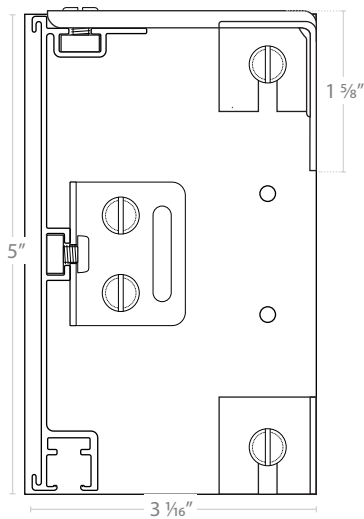

URBAN 5 RETURN 3
Showing all hardware

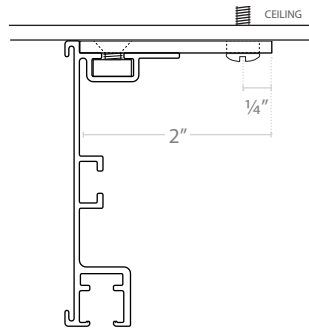

URBAN 3 CEILING SUPPORT

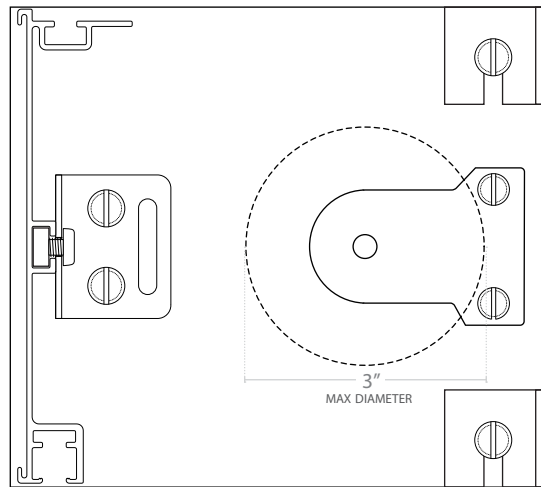

URBAN 5 - RETURN 5.5
Shade installation

TEKNO 40 WOOD

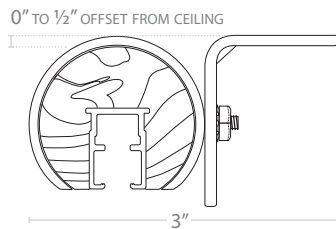

CEILING SUPPORT

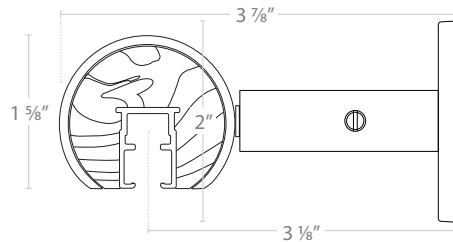

WALL SUPPORT

TECHNICAL INFORMATION • TEKNO PRODUCTS

NEXGEN

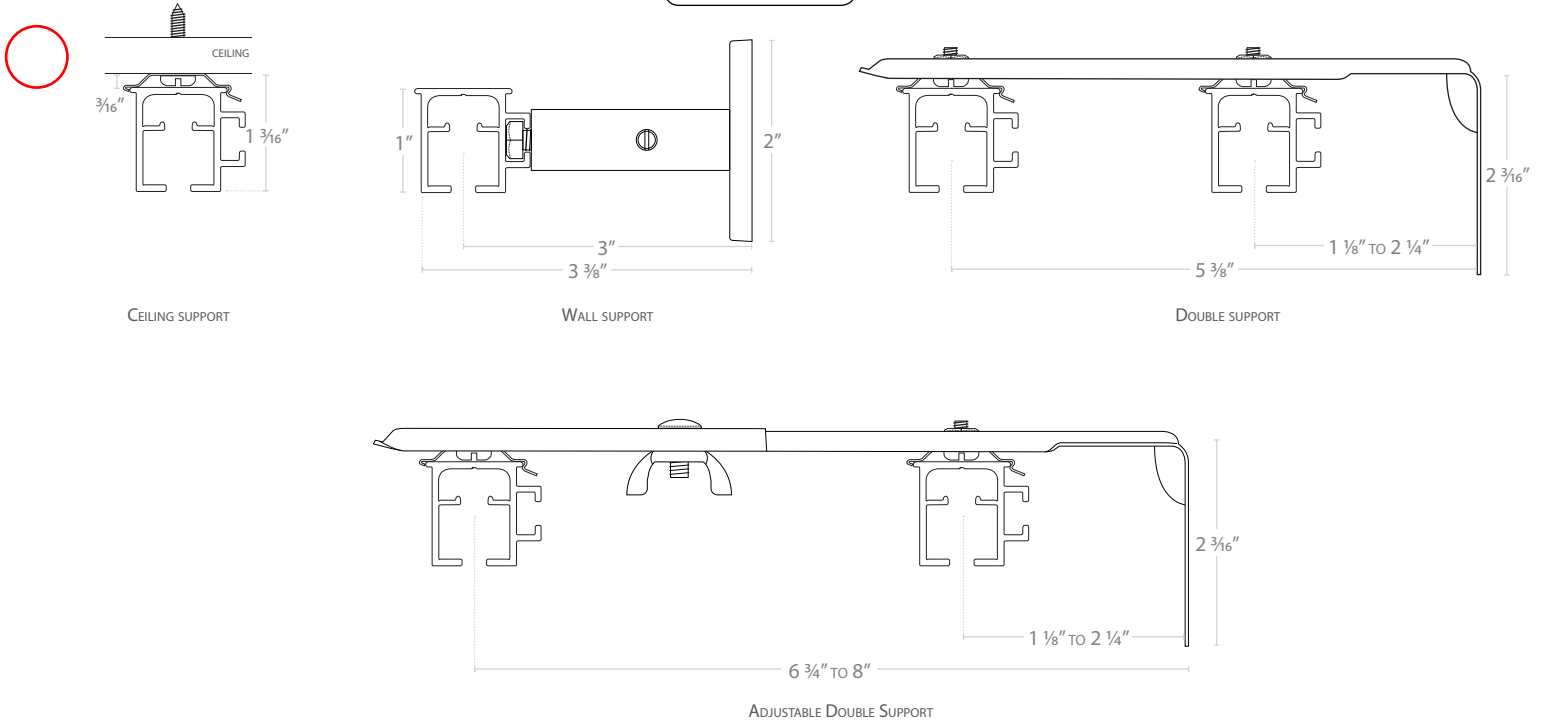

TEKNO 40

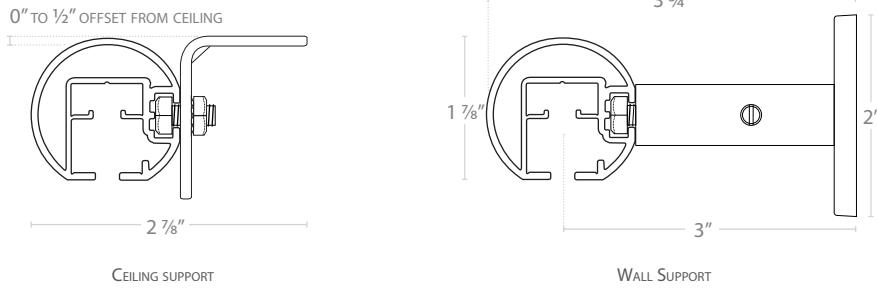

NEXGEN WOOD

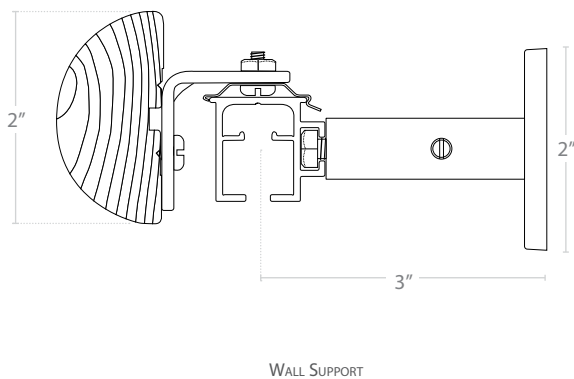

EURO-SCOPE UPGRADE

Offset between Euro-Scope Upgrade & front rod.

KONTUR EVO & ALU	$\frac{7}{16}''$
NEXGEN	$\frac{1}{2}''$
NEXGEN WOOD	$\frac{1}{2}''$
TEKNO 25	$\frac{1}{2}''$
TEKNO 40	$\frac{1}{4}''$
TEKNO 40 WOOD	$\frac{1}{2}''$

i Make Back drape a minimum of $\frac{3}{4}''$ shorter than front drape.

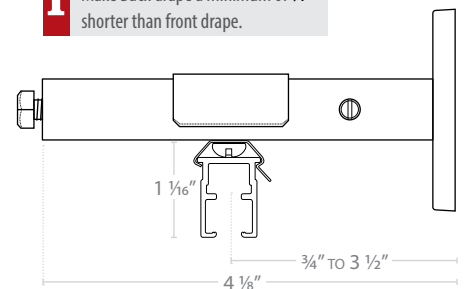

EURO-SCOPE INSTALLATION
 4" Support shown

ARTFIL • THE ART OF SUSPENSION

ALL KITS COME WITH 10 FEET OF WIRE.
THERE IS NO EXTRA CHARGE FOR WIRE LENGTHS UP TO 16 FEET (MUST BE REQUESTED).

AVAILABLE
COLORS



B
BRASS



N
NICKEL

OPTIONAL PRODUCTS



HBP0450
CLASSIQUE CENTER SUPPORT



HBP5400
S-HOOK



HBP0350
BOLLA CENTER SUPPORT



HBP5280
RING WITH PINCH CLIP



ARTFIL CLASSIQUE

KIT EQUERRE - HBA9542
WALL OR CEILING INSTALLATION (CENTER SUPPORT NOT INCLUDED)
Center support is required for lengths greater than 72"

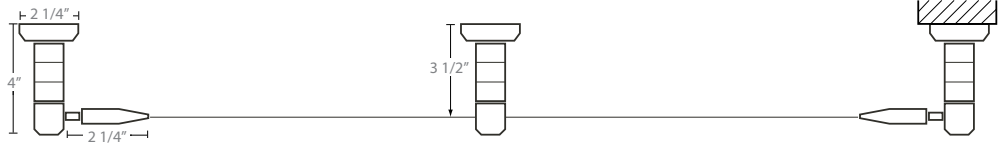

KIT CONIQUE - HBA9543
INSIDE WALL MOUNT INSTALLATION
Center support is required for lengths greater than 72"



ARTFIL BOLLA

KIT EQUERRE BOLLA - HBA9433
WALL OR CEILING INSTALLATION (CENTER SUPPORT NOT INCLUDED)
Center support is required for lengths greater than 72"

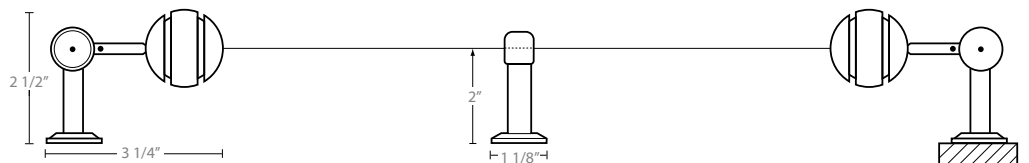

KIT CONIQUE BOLLA - HBA9432
INSIDE WALL MOUNT INSTALLATION
Center support is required for lengths greater than 72"

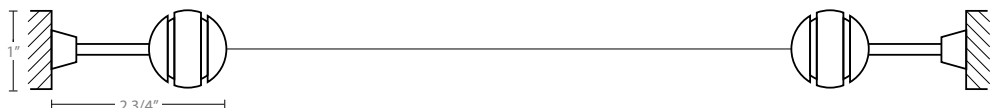

RIVER ROCKS • 5/8" DIAMETER



CONO

HFP0017
1 5/8" L X 1 1/4" DIA.
Shown in Fossil



KUGEL

HFP0027
1 1/4" L X 1 1/4" DIA.
Shown in Russette



RIALTO

HFP0107
1 1/2" L X 1 3/8" DIA.
Shown in Antique



TONIC

HFP0097
1 1/2" L X 1 3/8" DIA.
Shown in Stainless



TOSTANO

HFP0087
1 3/8" L X 5/8" H
Shown in Stainless



Available colors
Rods, finials & supports



A
ANTIQUE



F
FOSSIL



RS
RUSSETTE



S
STAINLESS

RODS



Rod measurement: Measure for ROD LENGTH ONLY
Maximum length for a single rod is 84".
Rods greater than 84" will be shipped in 2 equal pieces.



HFTS3007
STEEL TUBE

Above 72" length requires center support

ADJUSTABLE ROD KITS [SUPPORTS INCLUDED]



HAA1624 28" to 48"
HAA1684 48" to 84"
HAA1666 66" to 120"

SUPPORTS



HFP6027
EURO SUPPORT 2



HFP6047
EURO SUPPORT 4



HFP4027S - EXTENDER POST 2"
HFP4047S - EXTENDER POST 4"
Extends Euro Support

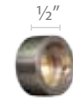

HFP6167
EURO LATERAL SUPPORT

Inside mount -
deduct 1/4" from rod per bracket.
Use with ROD ONLY ensembles up to 72"



ADJUSTABLE SUPPORT 5/8" DIAMETER
HFP6107 - SMALL 2 1/4" to 2 5/8"
HFP6307 - MEDIUM 3 1/4" to 5"
HFP6707 - LARGE 6 1/4" to 7 1/2"
wall to pole

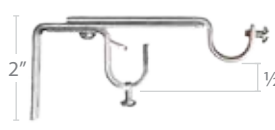

HAM1647
DOUBLE COMBO SUPPORT
Adj. projection - wall to pole
Front rod - 3 1/2" to 5 1/4"
Back rod - 1/4" to 2 3/8"



HFP6057
THE COMPACT
1/2" projection, wall to pole.
Ceiling or wall mount

OPTIONAL PRODUCTS



HAP7707
SAN FRANCISCO CORNER

AVAILABLE COLORS: A, K, P, RS, S



3/4" DIAMETER
HFP5207
RING EURO 20
Use with Ring Clip 48



1" DIAMETER
HFP5347
RING EURO 34
Use with Ring Clip 48



HBP5480
RING CLIP 48



1" DIAMETER
HAA1625
RING WITH EYELET
Bag of 10



1" DIAMETER
HAA1635
RING WITH PINCH CLIP
Bag of 10

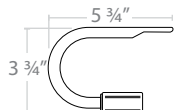

HFP4557
UNI-ARM 16



Order finial and post separately.

TIEBACKS



TONIC WITH 2" POST



RIALTO WITH 2" POST



TOSTANO WITH 4" POST



KUGEL WITH 2" POST



CONO WITH 2" POST

SIMPLICITÉ • 1 1/8" DIAMETER



AERONAUT

HAP0658

3 1/2" L x 2" DIA.

Shown in Chrome - Black - Chrome

*Available colors:
CKC, CSC, SCS



CERAMIC BALL

HAP0688

3 3/8" L x 2 1/2" DIA.

Shown in Stainless

Available colors:
CR, S



DIGITAL

HAP0598

3" L x 1 3/8" DIA.

Shown in Stainless

Available colors:
CR, DW, OB, S



EMPIRE

HFP0548

7/8" L x 1 3/8" DIA.

Shown in Chrome

Available colors:
CR, DW, OB, S



GEMSTONE

HAP0588

4" L x 2 1/8" DIA.

Shown in Distressed Wood

Available colors:
CR, DW, OB, S



JOFFRE

HAP0608

4" L x 2 1/8" DIA.

Shown in Antique Silver

Available colors:
AS, DW, OB



LALIQUE

HAP0678

1 3/4" L x 3" DIA.

Shown in Oil Rubbed Bronze

Available colors:
AS, DW, OB



LINEA

HFP0568

3 3/8" L x 2" DIA.

Shown in Stainless

Available colors:
CR, DW, OB, S



MERCADO

HAP0668

2 5/8" L x 2 3/8" DIA.

Shown in Distressed Wood

Available colors:
AS, DW, OB



MUSKOKA

HAP0628

3 7/8" L x 2 5/8" DIA.

Shown in Oil Rubbed Bronze

Available colors:
AS, DW, OB



SILESTE

HAP0578

2 1/8" L x 2" DIA.

Shown in Chrome

Available colors:
CR, S



TAMA

HAP0638

3 5/8" L x 2 1/4" DIA.

Shown in Oil Rubbed Bronze

Available colors:
AS, DW, OB



TRANS LU

HFP0538

4" L x 2 1/8" DIA.

Shown in Stainless

Available colors:
CR, DW, OB, S

AVAILABLE COLORS



CR
CHROME



DW
DISTRESSED WOOD (BLACK)



OB
OIL RUBBED BRONZE



S
STAINLESS

COLOR FOR CERTAIN FINIALS ONLY



AS
ANTIQUÉ SILVER
PAIRS WITH STAINLESS ROD

*AERONAUT COLOR CODES

CKC - CHROME, BLACK, CHROME
CSC - CHROME, STAINLESS, CHROME
SCS - STAINLESS, CHROME, STAINLESS

RODDING

i Set Length - Factory will NOT cut rodding



STEEL TUBE

HATS3488 - 48"
HATS3608 - 60"
HATS3728 - 72"
HATS3968 - 96"

SUPPORTS

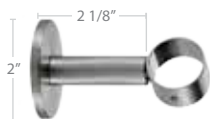

HFP6128

STAHL SUPPORT 2"

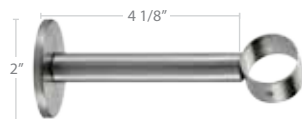

HFP6148

STAHL SUPPORT 4"



HAM6008

COMBO SUPPORT SELECT 28



HFP6168

LATERAL SUPPORT 28

Inside mount - deduct 1/4" from rod per bracket.
Maximum length of rod is 72"

OPTIONAL PRODUCTS



HAA5255

RING WITH EYELET
Bag of 10



HFP5458

METRO RING
Eyelet included



HMP7360 - 36"
HMP7480 - 48"
HMP7600 - 60"

ALUMINIUM FLING WANDS

AVAILABLE COLORS: BR, DA



HFP4468
UNI-ARM 28

ADJUSTABLE ROD KITS • 5/8" - 1/2" DIAMETER



ADRIA	ANTELOPE	BALL	CODA	LARGE BALL	RENAISSANCE	TORCH	TULIPE
HAA1609 3 7/8" L X 2" DIA. <i>Shown in Fossil</i>	HAA1626 4 1/2" L X 2 1/2" DIA. <i>Shown in Antique</i>	HAA1616 1 1/2" L X 1" DIA. <i>Shown in Stainless</i>	HAA1628 5 1/8" L X 2" DIA. <i>Shown in Desert</i>	HAA1606 2 3/4" L X 2" DIA. <i>Shown in Antique</i>	HAA1621 4 7/8" L X 2 1/2" DIA. <i>Shown in Pewter</i>	HAA1614 5 1/2" L X 2" DIA. <i>Shown in Russette</i>	HAA1622 2 7/8" L X 2" DIA. <i>Shown in Onyx</i>

Available colors
Rods & finials

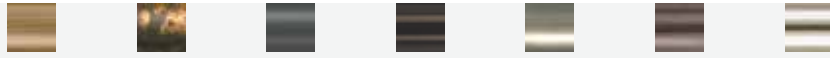

A	D	F	K	P	RS	S
ANTIQUE	DESERT	FOSSIL	ONYX	PEWTER	RUSSETTE	STAINLESS

Ensembles include:
Adjustable rod, finials & regular Combo Supports

KITS

Doublette ensembles include:
Back bracket & adjustable back rod.

	ADRIA	ANTELOPE	BALL	CODA	LARGE BALL	RENAISSANCE	TORCH	TULIPE	DOUBLETTE	ROD KITS
Pair of finials	HAA1609	HAA1626	HAA1616	HAA1628	HAA1606	HAA1621	HAA1614	HAA1622	-	-
28" - 48"	HAA2409	HAA2267	HAA2416	HAA2287	HAA2406	HAA2421	HAA2414	HAA2422	HAA2400	HAA1624
48" - 84"	HAA8409	HAA8267	HAA8416	HAA8287	HAA8406	HAA8421	HAA8414	HAA8422	HAA8400	HAA1684
66" - 120"	HAA6609	HAA6267	HAA6616	HAA6287	HAA6606	HAA6621	HAA6614	HAA6622	HAA6600	HAA1666
Tieback ensemble	HAA4509	HAA4267	HAA4516	HAA4287	HAA4506	HAA4521	HAA4514	HAA4522	-	-

SWING ARM



LENGTHS	ADRIA	ANTELOPE	BALL	CODA	LARGE BALL	RENAISSANCE	TORCH	TULIPE	NO FINIAL
14" - 22"	HAA5509	HAA5526	HAA5516	HAA5528	HAA5506	HAA5521	HAA5514	HAA5522	HAA5500
28" - 36"	HAA5609	HAA5626	HAA5616	HAA5628	HAA5606	HAA5621	HAA5614	HAA5622	HAA5600

SAN FRANCISCO PROGRAM

Ensembles include:
(1) adjustable wall rod, (2) adjustable wing rods,
(2) San Francisco Corners, (4) supports
(Finials Sold separately)

Available colors (CORNER COLOR / ROD COLOR)
ANTIQUE/DESERT, FOSSIL/ONYX, PEWTER/PEWTER
RUSSETTE/RUSSETTE, STAINLESS/STAINLESS

CODE	WALL ROD	WING RODS
HAA2818	28" - 48"	18" - 32"
HAA2828	28" - 48"	28" - 48"
HAA4818	48" - 84"	18" - 32"
HAA4828	48" - 84"	28" - 48"
HAP7707	SAN FRANCISCO CORNER 5/8" DIAMETER	



CURVED ROD

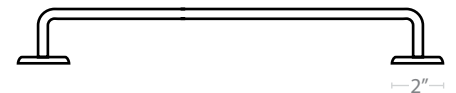

LENGTHS	28" - 48"	48" - 84"	66" - 120"
CODE	HAA7024	HAA7048	HAA7084

OPTIONAL PRODUCTS & SUPPORTS



HAM1647
DOUBLE COMBO SUPPORT
Adj. projection - wall to pole
Front rod - 3 1/2" to 5 1/4"
Back rod - 1/4" to 2 5/8"



HAM1600
COMBO SUPPORT
3 1/2" to 5 1/4" Adj. projection,
wall to pole



HAM1641
SHORT COMBO SUPPORT
1 7/8" to 2 3/8" Adj. projection,
wall to pole



HAM1643
LATERAL SUPPORT [PAIR]



HAA1625
RING WITH EYELET
Bag of 10



HAA1635
RING WITH PINCH CLIP
Bag of 10



HAM1645
TIEBACK [PAIR]
Finials not included

ADJUSTABLE ROD KITS • 5/8" - 3/4" DIAMETER



FLAIRISTE

HAP0042
3 1/8" L x 1 3/8" DIA.
Shown in Distressed Wood
Available colors: DW



FLW 18

HAP0032
2 1/2" L x 2 1/4" DIA.
Shown in Oil Rubbed Bronze
Available colors: AS, DW, OB, RS



IONIC 18

HAP0012
2 5/8" L x 2 1/4" DIA.
Shown in Distressed Wood
Available colors: AS, DW, OB, RS



LUCINDA

HAP0082
3 5/8" L x 1" DIA.
Shown in Chrome
Available colors: CR



NITRO

HAP0052
3" L x 1 1/4" DIA.
Shown in Antique Silver
Available colors: AS



STYBAL 18

HAP0022
2 3/8" L x 2 3/8" DIA.
Shown in Antique Silver
Available colors: AS, DW, OB, RS

AVAILABLE COLORS



AS ANTIQUE SILVER, CR CHROME, DW DISTRESSED WOOD, OB OIL RUBBED BRONZE, RSP RUSSETTE PAINT

ADJUSTABLE ROD KITS

FINIALS	FLAIRISTE	FLW 18	IONIC 18	LUCINDA	NITRO	STYBAL 18	DOUBLETTE
28" - 48"	HAA2042	HAA2032	HAA2012	HAA2082	HAA2052	HAA2022	HAA2002
48" - 84"	HAA8042	HAA8032	HAA8012	HAA8082	HAA8052	HAA8022	HAA8002
60" - 108"	HAA6042	HAA6032	HAA6012	HAA6082	HAA6052	HAA6022	HAA6002

- ENSEMBLES INCLUDE: ADJUSTABLE ROD, FINIALS AND REGULAR COMBO SUPPORTS.
- DOUBLETTE ENSEMBLES INCLUDE: BACK BRACKETS AND ADJUSTABLE BACK ROD.

SAN FRANCISCO PROGRAM

CODE	WALL ROD	WING RODS	COLOR	90° CORNER ANGLE	COLOR MATCHING TABLE
HAA2182	28" - 48"	18" - 32"	AS, DW, OB, RS		ROD COLOR ANTIQUE SILVER (AS) DISTRESSED WOOD (DW) OIL RUBBED BRONZE (OB) RUSSETTE (RSP)
HAA2282	28" - 48"	28" - 48"	AS, DW, OB, RS		
HAA4182	48" - 84"	18" - 32"	AS, DW, OB, RS		
HAA4282	48" - 84"	28" - 48"	AS, DW, OB, RS		
HFP7702	SAN FRANCISCO CORNER 3/4" DIA.		A, K, RS, S		CORNER COLOR STAINLESS (S) ONYX (K) ONYX (K) RUSSETTE (RS)

ENSEMBLES INCLUDE: (1) ADJUSTABLE WALL ROD, (2) ADJUSTABLE WING RODS, (2) SAN FRANCISCO CORNERS, (4) SUPPORTS
FINIALS NOT INCLUDED

OPTIONAL SUPPORTS



HAM6002
COMBO SUPPORT SELECT 18
Supports are included in ensembles, use for replacement parts only



HFP6472
DOUBLE COMBO SUPPORT 18
Adjustable projection from wall to pole
Front rod - 3 1/2" to 5 1/4"
Back rod - 1/4" to 2 5/8"



HFP6102
SHORT COMBO SUPPORT 18
Adjustable projection 1 7/8" to 2 3/8" from wall to pole

OPTIONAL PRODUCTS



HMP7360 - 36"
HMP7480 - 48"
HMP7600 - 60"
ALUMINIUM FLING WANDS

AVAILABLE COLORS: BR, DA



HAA5355
RING WITH CLIP
Bag of 10



HAA5255
RING WITH EYELET
Bag of 10

ADJUSTABLE ROD KITS • 1" - 7/8" DIAMETER



BEACON

HAP0455

3 1/2" L X 2 1/4" DIA.

Shown in Sandal

Available colors: AS, DW, MR, SD



CRYSTALLINE

HAP0495

3" L X 1 1/4" DIA.

Shown in Stainless

Available colors: CR, S



IONIC 25

HAP0375

3" L X 2 1/2" DIA.

Shown in Distressed Wood

Available colors: AS, DW, OB, RS



LALIQUE

HAP0678

1 3/4" L X 3" DIA.

Shown in Antique Silver

Available colors: AS, DW, OB



MERCADO

HAP0668

2 3/8" L X 2 3/8" DIA.

Shown in Distressed Wood

Available colors: AS, DW, OB



MUSKOKA

HAP0628

3 7/8" L X 2 5/8" DIA.

Shown in Antique Silver

Available colors: AS, DW, OB



PLEATESSE

HAP0475

3" L X 2 1/2" DIA.

Shown in Maroon

Available colors: AS, DW, MR, SD



REVOLVE

HAP0385

2 1/2" L X 2 3/4" DIA.

Shown in Antique Silver

Available colors: AS, DW, OB, RS



SAPPHIRE

HAP0515

1" L X 1 1/2" DIA.

Shown in Chrome

Available colors: CR, S



STYBAL 25

HAP0435

2 3/4" L X 2 3/4" DIA.

Shown in Oil Rubbed Bronze

Available colors: AS, DW, OB, RS



TAMA

HAP0638

3 5/8" L X 2 1/4" DIA.

Shown in Oil Rubbed Bronze

Available colors: AS, DW, OB



VERMILION

HAP0505

2 3/4" L X 2 1/4" DIA.

Shown in Distressed Wood

Available colors: AS, DW



AVAILABLE COLORS



AS

ANTIQUE SILVER



CR

CHROME



DW

DISTRESSED WOOD



MR

MAROON



OB

OIL RUBBED BRONZE



RSP

RUSSETTE PAINT



SD

SANDAL

COLOR FOR CERTAIN FINIALS ONLY



S

STAINLESS

PAIRS WITH ANTIQUE SILVER ROD

ADJUSTABLE ROD KITS

FINIALS

28" - 48"

48" - 84"

60" - 108"

BEACON

HAA2455

HAA8455

HAA6455

CRYSTALLINE

HAA2495

HAA8495

HAA6495

IONIC 25

HAA2375

HAA8375

HAA6375

LALIQUE

HAA2675

HAA8675

HAA6675

MERCADO

HAA2665

HAA8665

HAA6665

MUSKOKA

HAA2625

HAA8625

HAA6625

PLEATESSE

HAA2475

HAA8475

HAA6475

REVOLVE

HAA2385

HAA8385

HAA6385

SAPPHIRE

HAA2515

HAA8515

HAA6515

STYBAL 25

HAA2435

HAA8435

HAA6435

TAMA

HAA2635

HAA8635

HAA6635

VERMILION

HAA2505

HAA8505

HAA6505

DOUBLETTE

HAA2002

HAA8002

HAA6002

• ENSEMBLES INCLUDE: ADJUSTABLE ROD, FINIALS AND REGULAR COMBO SUPPORTS. • DOUBLETTE ENSEMBLES INCLUDE: BACK BRACKET AND ADJUSTABLE BACK ROD.

OPTIONAL SUPPORTS



HAM6005

COMBO SUPPORT SELECT 25

Supports are included in ensembles, use for replacement parts only



HFP6475

DOUBLE COMBO SUPPORT 25

Adjustable projection from wall to pole
Front rod - 3" to 4 1/8"
Back rod - 1/4" to 2 5/8"



OPTIONAL PRODUCTS



HMP7360 - 36"

HMP7480 - 48"

HMP7600 - 60"

ALUMINIUM FLING WANDS



AVAILABLE COLORS: BR, DA



HAA5355

RING WITH CLIP

Bag of 10



HAA5255

RING WITH EYELET

Bag of 10

WROUGHT IRON • 3/4" DIAMETER



AVAILABLE COLORS

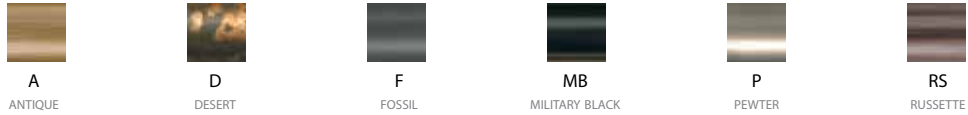

RODDING



HFTS3002 - STEEL TUBE

- ALL MEASUREMENTS MUST BE FOR ROD LENGTH ONLY.
- MAXIMUM LENGTH FOR A SINGLE ROD IS 96".
- AFTER 84" A CENTER SUPPORT IS REQUIRED.
- RODS GREATER THAN 96" WILL BE SHIPPED IN 2 EQUAL PIECES.

SUPPORTS

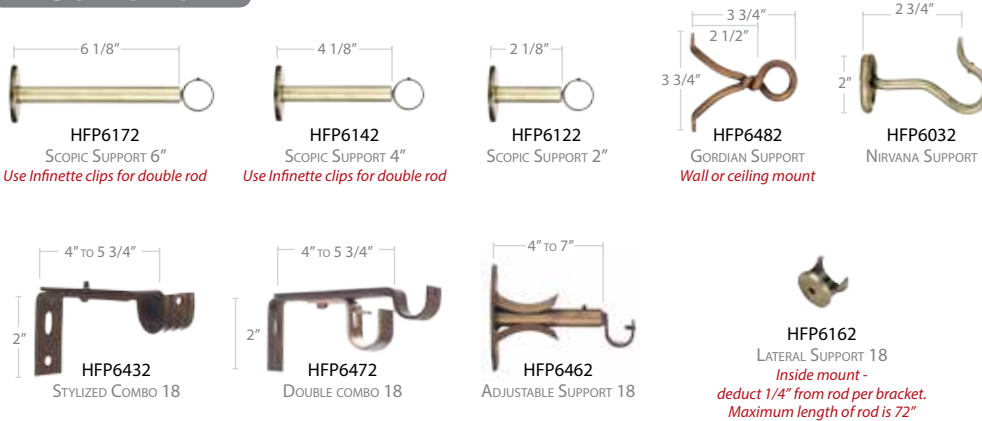

OPTIONAL PRODUCTS



INFINETTE CLIPS



WROUGHT IRON • 1" DIAMETER



AVALON	CAPUCHON 25	FABRIXX	FLAMME 25	GRAPPA	PIPER	SEQUOIA	TRINITY
HFP0105 7" L X 2 1/2" D Shown in Antique	HFP0185 1" L X 1 3/8" D Shown in Russette	HFP0485 3 3/4" L X 2 1/4" D Shown in Antique	HFP0255 4 1/4" L X 3" D Shown in Military Black	HAP0335 3 3/4" L X 2 1/4" D Shown in Antique	HFP0235 1 7/8" L X 1 3/4" D Shown in Pewter	HAP0425 4 1/4" L X 1 3/4" D Shown in Russette	HFP0385 2 1/2" L X 1 3/4" D Shown in Antique

AVAILABLE COLORS



RODDING



Use 3/4" ONLY FOR BACK RODS WITH INFINETTE CLIPS OR DOUBLE COMBO 25

- ALL MEASUREMENTS MUST BE FOR ROD LENGTH ONLY.
- MAXIMUM LENGTH FOR A SINGLE ROD IS 96".
- AFTER 84" A CENTER SUPPORT IS REQUIRED.
- RODS GREATER THAN 96" WILL BE SHIPPED IN 2 EQUAL PIECES.

SUPPORTS



HFP6175
ELYPTIC SUPPORT 6"
Use Infinette clips for double rod



HFP6145
ELYPTIC SUPPORT 4"
Use Infinette clips for double rod

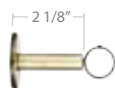

HFP6125
ELYPTIC SUPPORT 2"



HFP6165
LATERAL SUPPORT 25
Inside mount -
deduct 1/4" from rod per bracket.
Maximum length of rod is 72"



HFP6435
STYLIZED COMBO 25



HFP6475
DOUBLE COMBO 25



HFP6485
AVALON SUPPORT
Wall or ceiling mount



HFP6035
GINSA SUPPORT

OPTIONAL PRODUCTS



HFP5558
RING 55
Use Ring Clip 56
(Sold separately)



HFP5262
STEEL RING
Use Ring Clip 48
(Sold separately)
Liner included



HFP5282
STEEL RING WITH EYELET
Liner included



HMP7360 - 36"
HMP7480 - 48"
HMP7600 - 60"
ALUMINIUM FLUNG WANDS
AVAILABLE COLORS: BR, DA

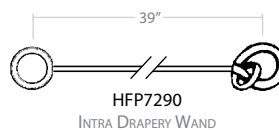

HFP7290
INTRA DRAPERY WAND



HFP7100 - 39"
FUSION FLUNG WAND
AVAILABLE COLORS: A, D, F, P, RS



HBP5560
RING CLIP 56



HBP5480
RING CLIP 48

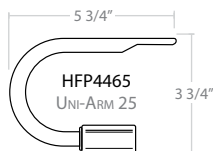

HFP4465
UNI-ARM 25



HFP4460
NEWTON TIEBACK
7" x 3 3/4"

INFINETTE CLIPS



HFP6712
REGULAR CLIP 3/4"
Attaches 3/4" diameter rods
to Elyptic Supports



HFP6722
BUTTERFLY CLIP 3/4"
Bridges 3/4" diameter rods
to Elyptic Supports



HFP6732
ALTERNATE CLIP
Attaches an alternate rod
to a Elyptic Support



HFP6742
ALTERNATE BUTTERFLY CLIP
Attaches an alternate rod
to a Elyptic Support

i Available colors for **finials** are identified in **RED TEXT**.

METRO • 1 1/8" DIAMETER



BALL 28

BARO 28

EMPIRE

EXCENTRIX

LINEA

OVAL 28

TRANS LU

HFP0048

3 3/8" L x 2 3/8" D
Shown in Antique

HAP0328

4 1/4" L x 2 3/8" D
Shown in Russette
A, DW, RS

HFP0548

7/8" L x 1 5/8" D
Shown in Chrome

HAP0318

4" L x 2 3/4" D
Shown in Antique
A, DW, RS

HFP0568

4" L x 2" D
Shown in Stainless

HFP0468

2 1/8" L x 2 1/8" D
Shown in Distressed Wood

HFP0538

4" L x 2 1/8" D
Shown in Stainless

AVAILABLE COLORS



A
ANTIQUE



CR
CHROME



DW
DISTRESSED WOOD



RS
RUSSETTE



S
STAINLESS

RODDING



HFTS3008
STEEL TUBE

- ALL MEASUREMENTS MUST BE FOR ROD LENGTH ONLY.
- MAXIMUM LENGTH FOR A SINGLE ROD IS 96".
- AFTER 84" A CENTER SUPPORT IS REQUIRED.
- RODS GREATER THAN 96" WILL BE SHIPPED IN 2 EQUAL PIECES.

SUPPORTS



HFP6128
STAHL SUPPORT 2"



HFP6148
STAHL SUPPORT 4"



HFP6178
STAHL SUPPORT 6"



HFP6168
LATERAL SUPPORT 28
Inside mount -
deduct 1/4" from rod per bracket.
Maximum length of rod is 72"

OPTIONAL PRODUCTS



HFP5458
METRO RING
Eyelet included

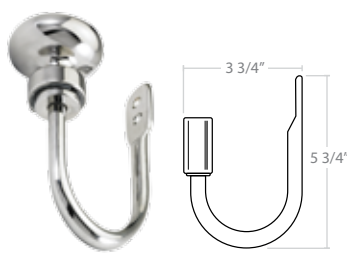

HFP4468
UNI-ARM 28



HMP7360 - 36"
HMP7480 - 48"
HMP7600 - 60"
ALUMINIUM FLING WANDS

AVAILABLE COLORS: BR, DA



EURO-SCOPE DOUBLE ROD UPGRADE

i Ensembles include: rodding, clic glides, and all necessary mounting hardware.

AVAILABLE COLORS: BR, DA, F, W

SIZE UP TO	36"	48"	60"	72"	84"	96"	*108"	*120"	*132"	*144"	*156"
SPLICE	0	0	0	0	0	0	1	1	1	1	1
HAND DRAWN	HEH4030	HEH4040	HEH4050	HEH4060	HEH4070	HEH4080	HEH4090	HEH4100	HEH4110	HEH4120	HEH4130
ONE WAY	HEO4030	HEO4040	HEO4050	HEO4060	HEO4070	HEO4080	HEO4090	HEO4100	HEO4110	HEO4120	HEO4130
CENTER DRAW	HEC4030	HEC4040	HEC4050	HEC4060	HEC4070	HEC4080	HEC4090	HEC4100	HEC4110	HEC4120	HEC4130

* RODS LONGER THAN 106" WILL BE SHIPPED IN TWO EQUAL PIECES TO AVOID HIGH TRANSPORT COSTS, BUT CAN BE ORDERED IN ONE PIECE WITH EXTRA SHIPPING AND HANDLING CHARGES.

PLEASE SPECIFY IF ONE PIECE IS REQUESTED.

i Available colors for **finials** are identified in **RED TEXT**.

WROUGHT IRON • 1 1/2" DIAMETER



ACCENT	ARON	ELFIN	GARIBALDI	MELROSE	SINGULAR	TAMA 40	TAP
HFP0024	HTP0204	HTP0284	HTP0304	HTP0274	HFP0074	HTP0294	HFP0014
3 5/8" L x 2 1/2" D	4" L x 2 3/4" D	4" L x 2 3/4" D	3 3/4" L x 2 5/8" D	4 3/4" L x 3 1/8" D	6" L x 2 3/8" D	4 1/4" L x 2 7/8" D	1/2" L x 1 5/8" D
Shown in Russette A, D, F, P, RS	Shown in Distressed Wood AS, DW, MR	Shown in Maroon AS, DW, MR	Shown in Pewter A, F, P, RS	Shown in Antique Silver AS, DW, MR	Shown in Pewter A, D, F, P, RS	Shown in Distressed Wood AS, DW, MR	Shown in Antique A, D, F, P, RS

AVAILABLE COLORS



COLOR FOR CERTAIN FINIALS ONLY



RODDING



HFTS3004
STEEL TUBE

- ALL MEASUREMENTS MUST BE FOR ROD LENGTH ONLY.
- MAXIMUM LENGTH FOR A SINGLE ROD IS 96".
- AFTER 84" A CENTER SUPPORT IS REQUIRED.
- RODS GREATER THAN 96" WILL BE SHIPPED IN 2 EQUAL PIECES.

SUPPORTS

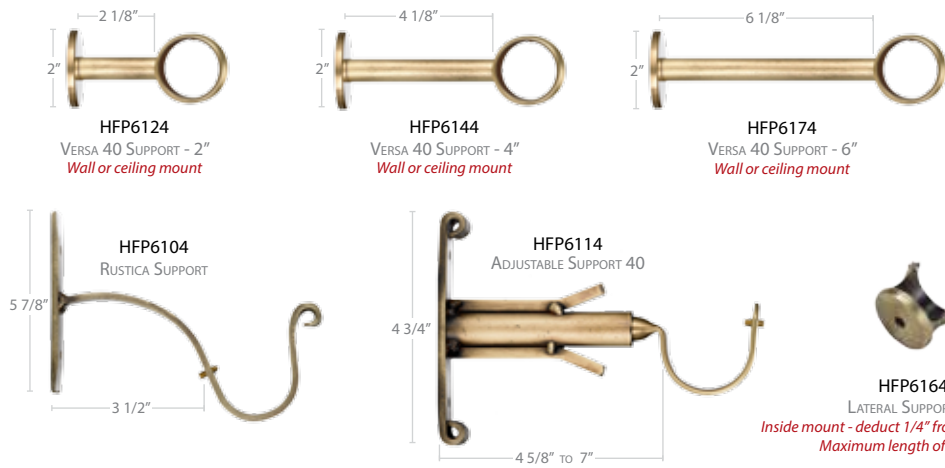

OPTIONAL PRODUCTS



HMP7360 - 36"
HMP7480 - 48"
HMP7600 - 60"
ALUMINUM FLING WANDS

AVAILABLE COLORS: BR, DA



HFP7100 - 39"
FUSION FLING WAND

AVAILABLE COLORS:
A, D, F, P, RS



HFP5824
RING 82
Use Ring Clip 83
(sold separately)



HFP5604
STEEL RING 40
With Eyelet
Liner included



HBP5830
RING CLIP 83



HFP4400
PASSAMA TIEBACK

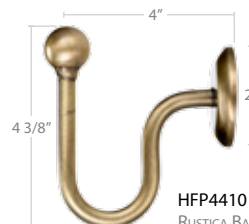

HFP4410
RUSTICA BALL TIEBACK



HFP4020
GANCHO HOOK

INFINETTE INSTALLATIONS



BUTTON

HBP0300
Ø 7/8"



CORD

HFP0820
Ø 2 1/2"



STAR

HFP0740
Ø 2 7/8"



FANETTE

HFP0720
Ø 2 3/4"



FORBIN

HFP0600
Ø 3"



FRANKI

HFP0750
Ø 2 3/4"



GRAPPA

HFP0620
Ø 3 1/2"



HORIZON

HFP0860
Ø 2 3/4"



LILLIANE

HFP0630
Ø 3 1/2"



LOUIS XVI

HBP0390
Ø 2 5/8"



LOUIS XV

HBP0310
Ø 2 3/4"



MANHATTAN

HFP0610
Ø 3"



PETALINE

HFP0640
Ø 3 1/2"



WAVES

HFP0760
Ø 2 3/4"

AVAILABLE COLORS



A
ANTIQUE



D
DESERT



F
FOSSIL



P
PEWTER



RS
RUSSETTE

RODDING

HFTS3007
STEEL TUBE - Ø 5/8"



Over 72" requires a center support

HFTS3002
STEEL TUBE - Ø 3/4"



Over 84" requires a center support

HIA1328



ADJUSTABLE ROD KIT 28" to 48"
Infinette Clips are included

HIA1348 48" to 84"
HIA1366 66" to 120"



ADJUSTABLE ROD KIT
Center support and
Infinette Clips are included

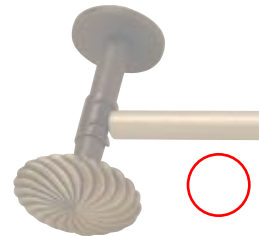

SUPPORTS

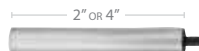

HFP4027 - 2"
HFP4047 - 4"
EXTENDER FOR POST COMPLETE



HFP4002 - 2"
HFP4004 - 4"
POST COMPLETE

SMALL: 1 7/8" to 2 3/8"
MEDIUM: 3 1/2" to 5 1/4"
LARGE: 6 1/4" to 7 1/2"



HFP6107 - 5/8" SUPPORT SMALL
HFP6307 - 5/8" SUPPORT MEDIUM
HFP6707 - 5/8" SUPPORT LARGE

Use as a center support instead of a medallion with post.



HFP6117 - 5/8"
HFP6112 - 3/4"
CRADLE
Cradle used as a rod support with Post Complete



HFP6137 - 5/8"
HFP6132 - 3/4"
CLOSED CRADLE
Closed Cradle is used as a rod support with Post Complete. Ideal for ceiling installations.



HFP6127 - 2"
HFP6147 - 4"
360° BRACKET WITH POST
Use for lateral, ceiling or angled installations

OPTIONAL PRODUCTS



HAP7707 - 5/8"
HAP7702 - 3/4"
SAN FRANCISCO CORNER



HFP5207
RING EURO 20
Use Ring Clip 48



HFP5347
RING EURO 34
Use Ring Clip 48



HFP5262
STEEL RING
Use Ring Clip 48 (Liner included)



HFP5282
STEEL RING WITH EYELET
Liner included



HFP7017 - 5/8"
HFP7012 - 3/4"
NYLON PLUG



HAA1635
RING WITH CLIP
Bag of 10



HBP5480
RING CLIP 48



HAA1625
RING WITH EYELET
Bag of 10

INFINETTE CLIPS



HFP6713 - 1/2"
HFP6717 - 5/8"
HFP6712 - 3/4"
REGULAR CLIP
Attaches rods to a Post Complete



HFP6723 - 1/2"
HFP6727 - 5/8"
HFP6722 - 3/4"
BUTTERFLY CLIP
Bridges rods to a Post Complete



HFP6732
ALTERNATE CLIP
Attaches an alternate rod to a Post Complete



HFP6742
ALTERNATE BUTTERFLY CLIP
Attaches an alternate rod to a Post Complete

BRASS COLLECTION • 1" DIAMETER



ENDCAP 25

HBP0115
1" L x 1 1/8" D
Shown in Brass
Available colors: B, K, N



REGENT

HBP0015
1 7/8" L x 1 1/16" D
Shown in Nickel
Available colors: B, K, N



BRAVA

HBP0215
2" L x 3" D
Shown in Brass
Available colors: B, K, N



FUEGO

HBP0105
4 1/2" L x 2" D
Shown in Brass
Available colors: B, K, N

CREATE YOUR FINIALS WITH PIECES IN BRASS, NICKEL OR ONYX!



KOSMO

HBA0415
1 7/8" L x 1 1/16" D
Combination shown:
Brass, Onyx, Brass (BKB)



URBAN

HBA0445
3" L x 1 5/8" D
Combination shown:
Nickel, Brass, Nickel (NBN)



MASONIC

HBA0505
2" L x 3" D
Combination shown:
Nickel, Onyx, Nickel, Onyx (NKNK)

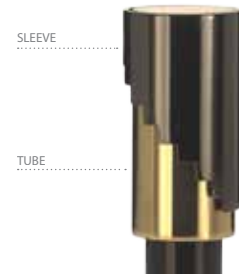

ESCALA

HBA0405
3" L x 1 5/8" D
Combination shown:
Onyx, Brass (KB)

AVAILABLE COLORS FOR BRASS PRODUCTS

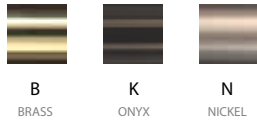

B BRASS
K ONYX
N NICKEL

AVAILABLE COLORS FOR WOOD RODS



CM CHERRY
WN WALNUT

RODDING



HBT3005 - BRASS TUBE



HBTW3005 - WOOD POLE

- ALL MEASUREMENTS MUST BE FOR ROD LENGTH ONLY.
- MAXIMUM LENGTH FOR A SINGLE ROD IS 96".
- AFTER 84" A CENTER SUPPORT IS REQUIRED.
- RODS GREATER THAN 96" WILL BE SHIPPED IN 2 EQUAL PIECES.

SUPPORTS

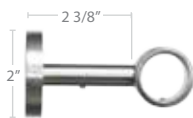

HBP6205 — SUPPORT 2"
HBP6225 — CENTER SUPPORT 2"



HBP6405 — SUPPORT 4 3/4"
HBP6425 — CENTER SUPPORT 4 3/4"



HBP6505
DOUBLE SUPPORT



HBP6605
STUDIO

Inside mount - deduct 3/16" from rod per bracket. Maximum length of rod is 72"

AVAILABLE COLORS: B, N

OPTIONAL PRODUCTS



HBP5558
RING 55
Use Ring Clip 56 (sold separately)



HBP5560
RING CLIP 56



HBP5478
CABLE RING
Use Ring Clip 48 (sold separately)



HBP5480
RING CLIP 48



Available colors: B, N

HBP4772 - 2"
HBP4774 - 3 3/8"
HBP4776 - 6"
BRAVA HOOK



Available color: A

HBP4782 - 2"
HBP4786 - 6"
LIBERTY HOOK



Available color: A

HBP4792 - 2"
HBP4794 - 4"
HBP4796 - 6 3/4"
LOUIS HOOK



Available color: A

HBP4751 - 1"
HBP4752 - 1 1/2"
HBP4754 - 2"
TRADITIONAL HOOK

BRASS COLLECTION • 1 1/8" DIAMETER



ENDCAP 28

HBP0208

1" L x 1 1/4" D

Shown in Brass

Available colors: B, N



BALBINA

HBP0138

3 1/4" L x 2 3/8" D

Shown in Brass

Available colors: B, N



CHALICE

HBP0238

2 1/2" L x 2 1/4" D

Shown in Nickel

Available colors: B, N



CALIENTE

HBP0108

4 1/8" L x 2" D

Shown in Brass

Available colors: B, N



SHIITAKE

HBP0098

2" L x 2 1/8" D

Shown in Nickel

Available colors: B, N



SYLO

HBP0268

2 1/4" L x 2 1/4" D

Shown in Nickel

Available colors: B, N



CORONA

HBP0058

4 1/2" L x 2 1/2" D

Shown in Brass

Available colors: A, B



LIBERTI

HBP0158

4 1/2" L x 2 3/4" D

Shown in Brass

Available colors: B



LOUIS XVI

HBP0048

3 3/4" L x 2 5/6" D

Shown in Brass

Available colors: A, B



RODOPLISSÉ

HBP0068

3 1/8" L x 2 1/4" D

Shown in Brass

Available colors: B



SHERATON

HBP0168

4 1/2" L x 2 1/2" D

Shown in Brass

Available colors: B



TORSADE

HBP0188

2 3/4" L x 2 3/4" D

Shown in Brass

Available colors: B

AVAILABLE COLORS FOR BRASS PRODUCTS



B

BRASS



N

NICKEL

COLOR FOR CERTAIN FINIALS ONLY



A

ANTIQUE

AVAILABLE COLORS FOR WOOD RODS



CM

CHERRY



WN

WALNUT

RODDING



HBT3008 - BRASS TUBE



HBTW3008 - WOOD POLE

- ALL MEASUREMENTS MUST BE FOR ROD LENGTH ONLY.
- MAXIMUM LENGTH FOR A SINGLE ROD IS 96".
- AFTER 84" A CENTER SUPPORT IS REQUIRED.
- RODS GREATER THAN 96" WILL BE SHIPPED IN 2 EQUAL PIECES.

SUPPORTS



HBP6308 — SUPPORT 3"
HBP6328 — CENTER SUPPORT 3"



HBP6508 — SUPPORT 4 7/8"
HBP6528 — CENTER SUPPORT 4 7/8"



HBP6808 — SUPPORT 7 1/4"
HBP6818 — CENTER SUPPORT 7 1/4"



HBP6608
STUDIO
Inside mount - deduct 3/16" from rod per bracket.
Maximum length of rod is 72"

OPTIONAL PRODUCTS



HBP5558
RING 55
Use Ring Clip 56 (sold separately)



HBP5560
RING CLIP 56



HBP5478
CABLE RING
Use Ring Clip 48 (sold separately)



HBP5480
RING CLIP 48



HBP4772 - 2"
HBP4774 - 3 3/8"
HBP4776 - 6"
BRAVA HOOK

Available colors: B, N



HBP4782 - 2"
HBP4786 - 6"
LIBERTI HOOK

Available color: A



HBP4792 - 2"
HBP4794 - 4"
HBP4796 - 6 3/4"
LOUIS HOOK

Available color: A



HBP4751 - 1"
HBP4752 - 1 1/2"
HBP4754 - 2"
TRADITIONAL HOOK

Available color: A

BRASS COLLECTION • 1 1/2" DIAMETER



BARTOLI

HBP0134

3 3/8" L x 2 1/2" D

Shown in Brass

Available colors: B, N



CALIX

HBP0144

3" L x 2 1/4" D

Shown in Nickel

Available colors: B, N



CORONET

HBP0174

3 1/8" L x 2 1/4" D

Shown in Brass

Available colors: B



FACETTE

HBP0074

4 1/2" L x 2 1/2" D

Shown in Brass

Available colors: B



LOUIS XV

HBP0024

4 3/4" L x 2 3/4" D

Shown in Brass

Available colors: B



SCEPTRE

HBP0244

4 1/2" L x 2 1/2" D

Shown in Brass

Available colors: A, B

CREATE YOUR FINIALS WITH PIECES IN BRASS OR NICKEL!

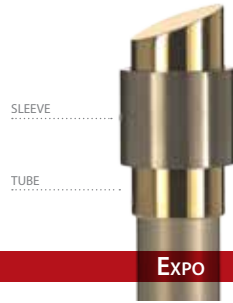

Expo

HBA0414

4" L x 2 1/8" D

Combination shown:

Tube in Brass, Sleeve in Nickel (BN)



ESCALA II

HBA0404

3 1/2" L x 2 1/8" D

Combination shown:

Sleeve in Nickel, Tube in Brass (NB)



OLYMPIC

HBA0424

3 1/2" L x 2 1/8" D

Combination shown:

Tube in Nickel, Rings in Brass (NB)

AVAILABLE COLORS



B

BRASS



N

NICKEL

COLOR FOR CERTAIN FINIALS ONLY



A

ANTIQUE

RODDING



HBT3004 - BRASS TUBE

- ALL MEASUREMENTS MUST BE FOR ROD LENGTH ONLY.
- MAXIMUM LENGTH FOR A SINGLE ROD IS 96".
- AFTER 84" A CENTER SUPPORT IS REQUIRED.
- RODS GREATER THAN 96" WILL BE SHIPPED IN 2 EQUAL PIECES.

SUPPORTS

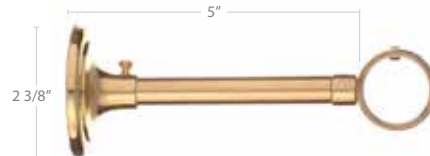

HBP6274 — SUPPORT 5"

HBP6284 — CENTER SUPPORT 5"

OPTIONAL PRODUCTS



HBP5824

RING 82

Use Ring Clip 83 (sold separately)



HBP5830

RING CLIP 83

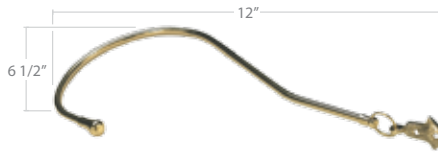

HBP4766

TUDOR TIEBACK
Available color: B



HBP4764.AL (LEFT)

HBP4764.AR (RIGHT)

MEDICI TIEBACK
Available color: A



HBP4772 - 2"
HBP4774 - 3 3/8"
HBP4776 - 6"
BRAVA HOOK

Available colors: B, N



HBP4782 - 2"
HBP4786 - 6"
LIBERTY HOOK

Available color: A



HBP4792 - 2"
HBP4794 - 4"
HBP4796 - 6 3/4"
LOUIS HOOK

Available color: A



HBP4751 - 1"
HBP4752 - 1 1/2"
HBP4754 - 2"
TRADITIONAL HOOK

Available color: A

A window with patterned curtains and a framed picture on the wall. The curtains have a repeating geometric pattern in shades of purple, blue, and white. The framed picture on the wall depicts a horse and rider in a field, with the text 'PHISH' and 'Vintage Performing Arts Co.' visible below the image.

“Urban offers hundreds of combinations with three simple numbers”

3, 5.5, 7.5

Claire Deco Inc.

CUSTOMER SERVICE: 1-514-340-1250 OR 1-800-361-4584

FAX 1-514-340-9423

www.clairedecoinc.com · info@clairedecoinc.com