

Forest Drapery Hardware

RETAIL PRICE GUIDE
VOLUME 19



TRACKS



METAL



WOOD



ROLLER SHADES



MOTORIZATION

THE WORLD BEHIND YOUR DRAPERIES

FOREST
DRAPERY HARDWARE

FOREST DRAPERY HARDWARE IS YOUR ONE STOP SHOP FOR DRAPERY

HARDWARE from high quality Forest Drapery Track Systems to beautiful decorative wood and metal pole and traversing collections to a variety of roller shades and motorized systems. Components featured in this catalog are stocked in our Atlanta warehouse ready to ship today. Assembled orders, built to your exact specifications, typically ship in 7-10 business days.



THE WORLD BEHIND YOUR DRAPERIES

WARRANTY & RETURNS: All returns must be approved prior to returning. A 25% restocking fee will be applied. No returns accepted after 30 days of receipt of order or on custom orders. Please inspect all packages upon receipt, note any loss or damage on the freight bill and immediately notify Forest Drapery Hardware. Claims must be reported within 3 business days. Forest Drapery Tracks are warranted for 10 years. All Forest Shuttle motors and the Forest Atlantis motor are warranted for 10 years. All other motors are warranted for one year. Forest Roller Shades are warranted for 1 year. Warranties do not apply to wear resulting from normal usage, damage from mishandling, abuse, or exposure due to climate conditions over which we have no control. No Forest products are warranted for outdoor use. All prices subject to change without notice. *Ripplefold is a trademark of Kirsch.

TABLE OF CONTENTS

TRACK, PANEL AND ROMAN BLIND SYSTEMS

CS Heavy Duty Track System	3-4
CL Heavy Duty Cam Lock Track System	5-6
CM Heavy Duty Ceiling Mount Track System	7-8
CCS Heavy Duty Corded Track System	9-10
MTS Medical Track System	11-12
KS Light-Medium Duty Klick System	13-14
DS Design System	15
DS XL Design System XL	16
RBS Roman Blind System	17
RBS XL Roman Blind System XL	18
PS Panel System	19-20
Bending & Curving	21-22
Batons	23
Workroom Components	24
Forest Easyflex FES System	24

DECORATIVE METAL HARDWARE

DRESDEN 3/4" Decorative Pole Sets	28
DRESDEN 1 1/8" Decorative Pole Sets	29-30
LISBON 1 3/16" Decorative Pole Sets	31-32
AVEIRO 1 3/16" Decorative Pole Sets	33-34
PORTO 3/4" Wrought Iron Pole Sets	35
PORTO 1 3/16" Wrought Iron Pole Sets	36
DRESDEN TRAVERSING 1 1/8"	39-40
NEW! DRESDEN CORDED 1 1/8" & 1 9/16"	41-42
DEVENTER CRS® TRAVERSING 1 1/8"	43-44
FRANKFURT TRAVERSING 1" Square Rail	45
STUTTGART TRAVERSING - 3 Contemporary Designs	
NEW! Flat Fascia	46
Rectangle Rail Hand Draw Traversing	47
C Rail Hand Draw Traversing	48
Oval Rail Hand Draw Traversing	49-50

DECORATIVE WOOD HARDWARE

VALENCIA 1 3/4" Pole Sets	53-54
SEVILLE 1 3/8" Pole Sets	55-56
CORDOBA 2" Pole Sets	57-58
GRANADA 2 3/4" Pole Sets	59-60
CORDOBA 2" & GRANADA 2 3/4" Traversing	61-62

ROLLER SHADES

Apollo Basic Roller Shades	65-68
Mercury Decorative Roller Shades	69-74
NEW! Climate Screen	75-76

MOTORIZATION

Forest SHUTTLE Motors	79-80
FMS Motorized Track System	81-82
FMS Plus Motorized Track System	83-84
RBS Motorized Roman Blind System	85
BCS Motorized Blind Contract System	86
DRESDEN Motorized Decorative Metal	87-90
CORDOBA & GRANADA Motorized Wood	91-92
NEW! MERCURY Motorized Roller Shades	93-96
ATLANTIS Motorized Heavy Duty Roller Shades	97-98

APPENDIX

Terms and Conditions	99
Warranty & Care Instructions and Child Safety	100
Ripplefold Carrier Counts	101-102
Marketing Support	103
Technical Support	104

A track for every occasion . . .
FOREST TRACK SYSTEMS

Forest Drapery Track Systems are installed worldwide in more than 75 countries, in both residential and commercial projects. Features include bending and curving options, easy installation, and ultra quiet operation.

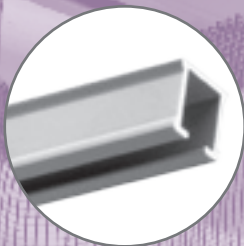

GFI[®]

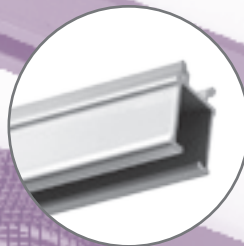

CL[®]

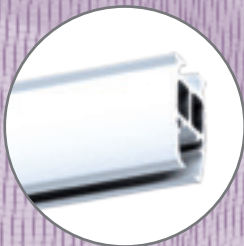

MTS[®]

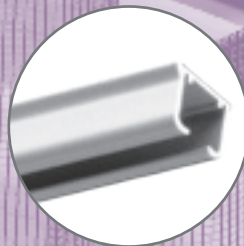

KS[®]



RBS[®]

*RBS can be **Motorized!***



RBS^{XL}

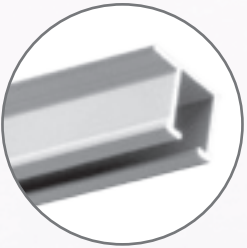

CM[®]



CCS[®]

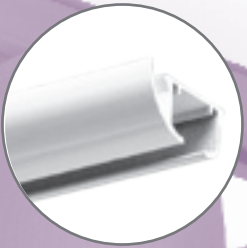

DS[®]



DSXL[®]

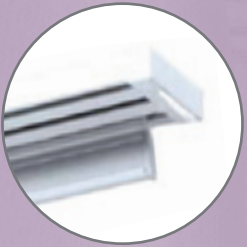

PS[®]



CS® - Contract System

The Hotel Track - Hand draw track system for hotels or any other heavy-duty use. Aluminum extrusion, powder coated and lubricated for wall or ceiling mount. Can be used with wood pole fascia or metal flat fascia. Available in -25 white, -59 black, -65 brown, and -90 silver.

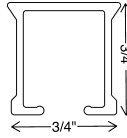

51012-25	white	12' x 20 tracks/bundle = 240'
51014-25	white	14' x 20 tracks/bundle = 280'
51016-25	white	16' x 20 tracks/bundle = 320'
51020-25	white	20' x 20 tracks/bundle = 400'
\$2.91/ft.		
51016-59	black	16' x 20 tracks/bundle = 320'
51020-59	black	20' x 20 tracks/bundle = 400'
51016-65	brown	16' x 20 tracks/bundle = 320'
51016-90	silver	16' x 20 tracks/bundle = 320'
\$3.20/ft.		

ASSEMBLED PRICING Includes track, carriers, masters, brackets and 36" fiberglass baton. Indicate pinch pleat, Ripplefold*, accordiafold or cubicle.

\$118.53 for the first 4 feet, \$11.66/additional foot. Colors other than white add 10%. Freight is additional.

BREAK PACK PRICING - Prices with this designation indicate a 20% up charge for broken pack quantities.



BEND/CURVE
PAGE 21

APPLICATION	PLEAT STYLE	STACKBACK	MOUNTING	MAX WEIGHT
Hand Draw	Ripplefold 6" per width		Wall	6 lbs/ft
One or Two Way	Pinch Pleat. 7" per width		Ceiling	Depending on application
	Cubicle 5" per width		Can be spliced	
	Accordiafold 5" per width			

TRACKS - CS

CS Carriers



2107-25 60% fullness, 2 5/8" OC
2106-25 80% fullness, 2 3/8" OC
2105-25 100% fullness, 2 1/8" OC
2108-25 120% fullness, 1 7/8" OC
 -59 Black + 10%
 Wheeled Connected Snap Carrier in plastic sleeve
 \$1.36 ea.
 \$1.14 ea./roll of 500



2006-25
 Wheeled Snap Carrier for accordiafold
 \$1.27 ea.
 \$1.06 ea./box of 500
2007-25
 Pendant for carrier
 \$0.20 ea.
 \$0.17 ea./box of 500



2004-25
 -59 Black + 10%
 Snap Carrier for accordiafold
 \$0.50 ea.
 \$0.42 ea./box of 500



2114-25 60% fullness, 2 5/8" OC
2111-25 80% fullness, 2 3/8" OC
2112-25 100% fullness, 2 1/8" OC
2115-25 120% fullness, 1 7/8" OC
 -59 Black + 10%
 Two-Piece Connected Snap Carrier w/ Square Base in plastic sleeve.
 Use 4 1/4" snap tape.
 \$1.10 ea.
 \$0.92 ea./roll of 500



52002-25
 -59 Black, -65 Brown + 10%
 Slim Line Ball Bearing Carrier
 \$0.61 ea.
 \$0.51 ea./box of 1000



52008-25
 -59 Black, -65 Brown +10%
 Slim Line Klick Carrier draperies hang to conceal track
 \$0.97 ea.
 \$0.80 ea./box of 250



52108-25
 -59 Black + 10%
 Stop Carrier prevents slide back
 \$1.97 ea.
 \$1.64 ea./box of 100



52003-25
 -65 Brown + 10%
 Economy Slide
 \$0.26 ea.
 \$0.22/box of 2000



52100-25
 Ball Bearing Carrier w/ Stainless Hook slim line - use w/ grommets
 \$1.67 ea.
 \$1.39 ea./box of 1000



52106-25
 Contract Klick Carrier w/ Stainless Hook use with grommets
 \$1.97 ea.
 \$1.64 ea./box of 100



9001-25
 J Hook, 1 1/8" use with **52106-XX**
 \$0.29 ea.
 \$0.24 ea./box of 1,000



52005-25
 Button Slide Carrier
 \$0.21 ea.
 \$0.18 ea./box of 1000



52105-25
 Button Slide Carrier w/ Hook
 \$0.65 ea.
 \$0.54 ea./box of 500



2202-25
 Button Slide Carrier w/ Breakaway Carrier
 \$1.51 ea.
 \$1.26 ea./bag of 5000

CS Masters

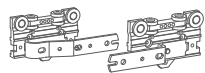

52502-25 Overlap R
52504-25 Underlap L
-59 Black + 10%
Standard Multi-Functional Master
Use stiffener w/ exposed baton or hooks w/ hidden baton
\$6.55 ea.
\$5.46 ea./box of 100

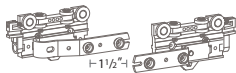

52502-25A Overlap R
52504-25A Underlap L
-59A Black + 10%
Standard Multi-Functional Master w/ snaps and baton adaptor
\$7.94 ea.
\$6.62 ea./box of 100

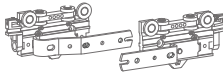

52502-25B Overlap R
52504-25B Underlap L
Standard Multi-Functional w/ baton adaptor for stiffener
\$6.55 ea.
\$5.46 ea./box of 50

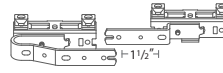

52508-25 Overlap R
52509-25 Underlap L
-59 Black, -65 Brown + 10%
Swivel Foot Multi-Functional Master
Use with bends and curves
\$11.55 ea.
\$9.62 ea./box of 100

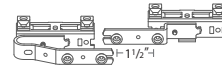

52508-25A Overlap R
52509-25A Underlap L
-59 Black, -65 Brown + 10%
Swivel Foot Multi-Functional Master w/ snaps
\$13.69 ea.
\$11.41 ea./box of 100



52501-25 Overlap R
52503-25 Underlap L
Stiffener Master
\$6.55 ea.
\$5.46 ea./box of 50



52401-25 Overlap R
52403-25 Underlap L
Stiffener Master w/ snaps and adaptor
\$8.03ea.
\$6.69 ea./box of 50



52410-25 Butt R
52409-25 Butt L
-59 Black + 10%
Standard Butt Master w/ snaps and for baton use
\$15.90 ea.
\$13.25 ea./box of 50

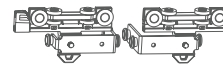

52411-25A Butt R
52412-25A Butt L
Wheeled Butt Master w/snap adaptor
Designed for hidden baton
\$28.09 ea.
\$23.41 ea./box of 50



52514-25 Overhead R
52515-25 Underhead L
Over the Top Baton Master
Designed for exposed baton
\$10.66 ea.
\$8.89 ea./box of 100

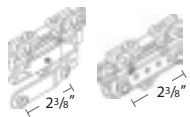

52601-25A Overlap R
52603-25A Underlap L
Extended Spacing Master w/ snaps and adaptor
\$5.31 ea.
\$4.42 ea./box of 100

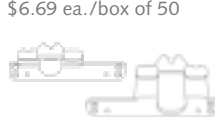

88809-23-00 Overlap R
88809-24-00 Underlap L
-59 Black + 10%
Plastic Snap Master
\$11.50 ea.
\$9.58 ea./box of 25



2552-25
6" Extension Arm for master
Use w/ two one-way draws
\$3.89 ea.
\$3.24 ea./box of 50

CS Brackets



3001-25
-59 Black, -65 Brown, -90 Silver + 10%
Regular Duty Ceiling
\$1.15 ea.
\$0.96 ea./box of 100



3002-25
Klick On Ceiling with steel spring clip for use with drop ceilings
\$1.43 ea.
\$1.19 ea./box of 100



3901-25
-59 Black, -65 Brown, -90 Silver + 10%
Ceiling Splice/Bracket
\$1.97 ea.
\$1.64 ea./box of 50

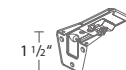

53202-25
-59 Black, -65 Brown, -90 Silver + 10%
3" Smart Klick Wall Bracket w/ wide base, adjusts 3-4.5"
\$2.91 ea.
\$2.43 ea./box of 100

CS Other Components



52301-25
-59 Blk, -65 Brn, -90 Slv + 10%
End Cap w/ Economy Slide
must add 2004-25 for Ripplefold*
\$1.06 ea.
\$0.88 ea./box of 400



52302-25 Right Return
52303-25 Left Return
End Cap w/ Return Plate, Snap for pinch pleat or Ripplefold*
\$2.02 ea.
\$1.69 ea./box of 100



2305-25
-59 Blk, -65 Brn, -90 Slv + 10%
Twist On End Stop
\$1.97 ea.
\$1.64 ea./box of 100



52307-90
End Lock
\$0.87 ea.
\$0.73 ea./box of 100

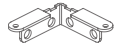

2308-25
Return Plate
reversible, 2 1/2" return
\$7.43 ea.
\$6.20 ea./box of 100



2551-25
Small Extension Arm
\$3.90 ea.
\$3.25 ea./box of 50



3003-25
-59 Black, -65 Brown, -90 Silver + 10%
Heavy Duty Ceiling w/ Smart Klick
\$1.97 ea.
\$1.64 ea./box of 100

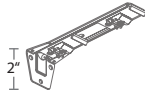

53206-25
-59 Black, -65 Brown, -90 Silver + 10%
6" Smart Klick Double Wall Bracket w/ wide base adjusts 2.5"-4" & 6"-7.5"
\$4.78 ea.
\$3.98 ea./box of 50



3280-25
-59 Black, -65 Brown, -90 Silver + 10%
3" Wall Bracket for Wood Poles, heavy duty projection 2 1/2"
\$10.85 ea.
\$9.04 ea./box of 20

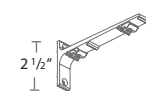

3281-25
-59 Black, -65 Brown + 10%
6" Double Wall Bracket for Wood Poles heavy duty projection 1 1/2", 5 1/2"
\$15.55 ea.
\$12.95 ea./box of 15



3903-25
-59 Blk, -65 Brn, -90 Slv + 10%
Track Connector and key
3904-00
\$16.68 ea.
\$13.90 ea./box of 10



54110-25
36" Fiberglass Baton w/ snap
\$6.89 ea.
\$5.74 ea./box of 100
See all batons p. 23



3284-25
-65 Brown, -90 Silver + 10%
10" Triple Wall Bracket for Wood Poles, heavy duty projection 2", 6 5/8", 9 5/16"
\$28.84 ea. or \$24.03 ea./10



3006-25
Suspension Bracket Tube & Top
39" extention
\$111.34 ea. 10/box



3009-25
Suspension Bracket Klick System Clip
\$2.22 ea.
\$1.85 ea./box of 50



CL - Cam Lock System

Aluminum extrusion, white, powder coated, lubricated for wall and ceiling mount. Designed for hotel use or any other heavy-duty application.

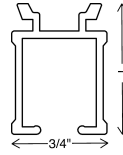

51512-25	white	12' x 20 tracks/bundle = 240'
51514-25	white	14' x 20 tracks/bundle = 280'
51516-25	white	16' x 20 tracks/bundle = 320'
51519-25	white	19' x 20 tracks/bundle = 380'
\$3.16/ft.		

ASSEMBLED PRICING includes track, carriers, masters, brackets and 36" fiberglass baton. Indicate pinch pleat, Ripplefold*, accordiafold or cubicle.

\$120.90 for the first 4 feet, \$11.90/additional foot. Freight is additional.

BREAK PACK PRICING - Prices with this designation indicate a 20% up charge for broken pack quantities.

APPLICATION	PLEAT STYLE	STACKBACK	MOUNTING	MAX WEIGHT
Hand Draw	Ripplefold*	... 6" per width	Wall	6 lbs/ft
One or Two Way	Pinch Pleat	... 7" per width	Ceiling	Depending on application
	Cubicle	... 5" per width	Can be spliced	
	Accordiafold	... 5" per width		

CL Carriers



2107-25 60% fullness, 2 5/8" OC
2106-25 80% fullness, 2 3/8" OC
2105-25 100% fullness, 2 1/8" OC
2108-25 120% fullness, 1 7/8" OC
 Wheeled Connected Snap Carrier in plastic sleeve
 \$1.36 ea.
 \$1.14 ea./roll of 500



2006-25
 Wheeled Snap Carrier for accordiafold
 \$1.27 ea.
 \$1.06 ea./box of 500
2007-25
 Pendant for carrier
 \$0.20 ea.
 \$0.17 ea./box of 500



2004-25
 Snap Carrier for accordiafold
 \$0.50 ea.
 \$0.42 ea./box of 500



2114-25 60% fullness, 2 5/8" OC
2111-25 80% fullness, 2 3/8" OC
2112-25 100% fullness, 2 1/8" OC
2115-25 120% fullness, 1 7/8" OC
 Two-Piece Connected Snap Carrier w/ Square Base
 In plastic sleeve. Use 4 1/4" snap tape.
 \$1.10 ea.
 \$0.92 ea./roll of 500



52002-25
 Slim Line
 Ball Bearing Carrier
 \$0.61 ea.
 \$0.51 ea./box of 1000



52008-25
 Slim Line Klick Carrier
 Draperies hang to conceal track
 \$0.97 ea.
 \$0.80 ea./box of 250



52108-25
 Stop Carrier prevents slide back
 \$1.97 ea.
 \$1.64 ea./box of 100



52003-25
 Economy Slide
 \$0.26 ea.
 \$0.22/box of 2000



52100-25
 Ball Bearing Carrier w/ Stainless Hook
 slim line for use w/ grommets
 \$1.67 ea.
 \$1.39 ea./box of 1000



52106-25
 Contract Klick Carrier w/ Stainless Hook
 use with grommets
 \$1.97 ea.
 \$1.64 ea./box of 100



9001-25
 J Hook, 1 1/8" use with 52106
 \$0.29 ea.
 \$0.24 ea./box of 1,000

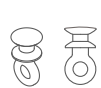

52005-25
 Button Slide Carrier
 \$0.21 ea.
 \$0.18 ea./box of 1000



52105-25
 Button Slide Carrier w/ Hook
 \$0.65 ea.
 \$0.54 ea./box of 500



2202-25
 Button Slide w/ Breakaway Carrier
 \$1.51 ea.
 \$1.26 ea./bag of 5000

CL Masters

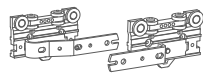

52502-25 Overlap R
52504-25 Underlap L
Standard Multi-Functional Master
Use stiffener w/ exposed baton
or hooks w/ hidden baton
\$6.55 ea.
\$5.46 ea./box of 100

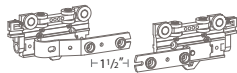

52502-25A Overlap R
52504-25A Underlap L
Standard Multi-Functional
Master w/ snaps and baton
adaptor
\$7.94 ea.
\$6.62 ea./box of 100

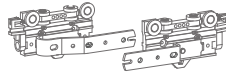

52502-25B Overlap R
52504-25B Underlap L
Standard Multi-Functional
w/ baton adaptor for stiffener
\$6.55 ea.
\$5.46 ea./box of 50



52501-25 Overlap R
52503-25 Underlap L
Stiffener Master
\$6.55 ea.
\$5.46 ea./box of 100



52401-25 Overlap R
52403-25 Underlap L
Stiffener Master
w/ snaps and adaptor
\$8.03 ea.
\$6.69 ea./box of 50



52410-25 Butt R
52409-25 Butt L
Standard Butt Master
w/ snaps and for baton use
\$15.90 ea.
\$13.25 ea./box of 50

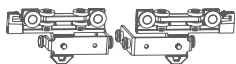

52411-25A Butt R
52412-25A Butt L
Wheeled Butt Master
w/snap adaptor
Designed for hidden baton
\$28.09 ea.
\$23.41 ea./box of 50



52514-25 Overhead R
52515-25 Underhead L
Over the Top Baton Master
Designed for exposed baton
\$10.66 ea.
\$8.89 ea./box of 100

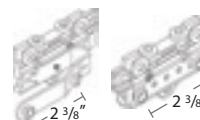

52601-25A Overlap R
52603-25A Underlap L
Extended Spacing Master
w/ snaps and adaptor
\$5.31 ea.
\$4.42 ea./box of 100

CL Brackets



53502-25
3" Wall Bracket
adjusts 3"- 4 1/2"
w/ metal cam lock
\$3.80 ea.
\$3.16 ea./box of 100



53506-25
6" Double Wall Bracket
adjusts 2 1/2"- 4" & 6"- 7 1/2"
w/ metal cam lock
\$4.67 ea.
\$3.89 ea./box of 50



53507-25
Ceiling Bracket
w/ metal cam lock
\$1.44 ea.
\$1.20 ea./box of 100

CL Other Components



52301-25
End Cap w/ Economy Slide
must add 2004-25 for Ripplefold*
\$1.06 ea.
\$0.88 ea./box of 400



52302-25 Right Return
52303-25 Left Return
End Cap w/ Return Plate & Snap
for pinch pleat or Ripplefold*
\$2.02 ea.
\$1.69 ea./box of 100



2305-25
Twist On End Stop
\$1.97 ea.
\$1.64 ea./box of 100



52307-90
End Lock
\$0.87 ea.
\$0.73 ea./box of 100



2308-25
Return Plate
reversible, 2 1/2" return
\$7.43 ea.
\$6.20 ea./box of 100



54110-25
36" Fiberglass Baton
w/ snap
\$6.89 ea.
\$5.74 ea./box of 100
See all batons p. 23



2551-25
Small Extension Arm
\$3.90 ea.
\$3.25 ea./box of 50



CM[®] - CEILING MOUNT

Heavy duty for direct ceiling mount - holes every 16". Aluminum extrusion, white.

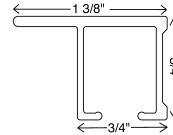

51212-25	white	12' x 20 tracks/bundle = 240'
51214-25	white	14' x 20 tracks/bundle = 280'
51216-25	white	16' x 20 tracks/bundle = 320'
\$3.20/ft.		

ASSEMBLED PRICING includes track, carriers, masters, and 36" fiberglass baton. Indicate pinch pleat, Ripplefold*, accordiafold or cubicle.

\$103.09 for the first 4 feet, \$8.55/additional foot. Freight is additional.

BREAK PACK PRICING - Prices with this designation indicate a 20% up charge for broken pack quantities.

APPLICATION	PLEAT STYLE	STACKBACK	MOUNTING	MAX WEIGHT
Hand Draw	Ripplefold* 6" per width		Direct Ceiling	6 lbs/ft
One or Two Way	Pinch Pleat 7" per width		Cannot be Spliced	Depending on application
	Cubicle 5" per width			
	Accordiafold 5" per width			

CM Carriers



2107-25 60% fullness, 2 5/8" OC
2106-25 80% fullness, 2 3/8" OC
2105-25 100% fullness, 2 1/8" OC
2108-25 120% fullness, 1 7/8" OC
 Wheeled Connected Snap Carrier in plastic sleeve
 \$1.36 ea.
 \$1.14 ea./roll of 500



2006-25
 Wheeled Snap Carrier for accordiafold
 \$1.27 ea.
 \$1.06 ea./box of 500
2007-25
 Pendant for carrier
 \$0.20 ea.
 \$0.17 ea./box of 500



2004-25
 Snap Carrier for accordiafold
 \$0.50 ea.
 \$0.42 ea./box of 500

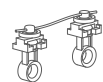

2114-25 60% fullness, 2 5/8" OC
2111-25 80% fullness, 2 3/8" OC
2112-25 100% fullness, 2 1/8" OC
2115-25 120% fullness, 1 7/8" OC
 Two-Piece Connected Snap Carrier w/ Square Base
 In plastic sleeve. Use 4 1/4" snap tape.
 \$1.10 ea.
 \$0.92 ea./roll of 500



52002-25
 Slim Line Ball Bearing Carrier
 \$0.61 ea.
 \$0.51 ea./box of 1000



52008-25
 Slim Line Klick Carrier
 Draperies hang to conceal track
 \$0.97 ea.
 \$0.80 ea./box of 250



52108-25
 Stop Carrier prevents slide back
 \$1.97 ea.
 \$1.64 ea./box of 100



52003-25
 Economy Slide
 \$0.26 ea.
 \$0.22/box of 2000



52100-25
 Ball Bearing Carrier w/ Stainless Hook
 slim line for use w/ grommets
 \$1.67 ea.
 \$1.39 ea./box of 1000



52106-25
 Contract Klick Carrier w/ Stainless Hook
 use with grommets
 \$1.97 ea.
 \$1.64 ea./box of 100



9001-25
 J Hook, 1 1/8" use with 52106
 \$0.29 ea.
 \$0.24 ea./box of 1,000



52005-25
 Button Slide Carrier
 \$0.21 ea.
 \$0.18 ea./box of 1000



52105-25
 Button Slide Carrier w/ Hook
 \$0.65 ea.
 \$0.54 ea./box of 500



2202-25
 Button Slide Carrier w/ Breakaway Carrier
 \$1.51 ea.
 \$1.26 ea./bag of 5000

CM Masters

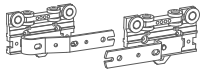

52502-25 Overlap R
52504-25 Underlap L
Standard Multi-Functional Master
Use stiffener w/ exposed baton
or hooks w/ hidden baton
\$6.55 ea.
\$5.46 ea./box of 100

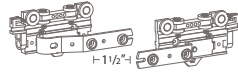

52502-25A Overlap R
52504-25A Underlap L
Standard Multi-Functional
Master w/ snaps and baton
adaptor
\$7.94 ea.
\$6.62 ea./box of 100

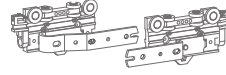

52502-25B Overlap R
52504-25B Underlap L
Standard Multi-Functional
w/ baton adaptor for stiffener
\$6.55 ea.
\$5.46 ea./box of 50



52501-25 Overlap R
52503-25 Underlap L
Stiffener Master
\$6.55 ea.
\$5.46 ea./box of 50



52401-25 Overlap R
52403-25 Underlap L
Stiffener Master
w/ snaps and adaptor
\$8.03 ea.
\$6.69 ea./box of 50



52410-25 Butt R
52409-25 Butt L
Standard Butt Master
w/ snaps and for baton use
\$15.90 ea.
\$13.25 ea./box of 50

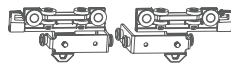

52411-25A Butt R
52412-25A Butt L
Wheeled Butt Master
w/snap adaptor
Designed for hidden baton
\$28.09 ea.
\$23.41 ea./box of 50



52514-25 Overhead R
52515-25 Underhead L
Over the Top Baton Master
Designed for exposed baton
\$10.66 ea.
\$8.89 ea./box of 100

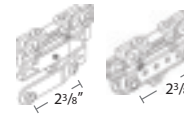

52601-25A Overlap R
52603-25A Underlap L
Extended Spacing Master
w/ snaps and adaptor
\$5.31 ea.
\$4.42 ea./box of 100

CM Other Components



52301-25
End Cap w/ Economy Slide
must add 2004-25 for Ripplefold*
\$1.06 ea.
\$0.88 ea./box of 400



52302-25 Right Return
52303-25 Left Return
End Cap w/ Return Plate & Snap
for pinch pleat or Ripplefold*
\$2.02 ea.
\$1.69 ea./box of 100



2305-25
Twist On End Stop
\$1.97 ea.
\$1.64 ea./box of 100



52307-90
End Lock
\$0.87 ea.
\$0.73 ea./box of 100



2308-25
Return Plate
reversible, 2 1/2" return
\$7.43 ea.
\$6.20 ea./box of 100



2551-25
Small Extension Arm
\$3.90 ea.
\$3.25 ea./box of 50



54110-25
36" Fiberglass Baton
w/ snap
\$6.89 ea.
\$5.74 ea./box of 100
See all batons p.23



CCS® - Contract Cord System

Aluminum extrusion, white, powder coated, lubricated, wall and ceiling mount with separate channels for use with cord. Can be used with wood pole fascia. Available in -25 white, -65 brown and -90 silver.

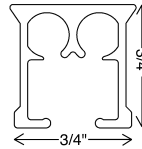

51112-25	white	12' x 20 tracks/bundle = 240'
51114-25	white	14' x 20 tracks/bundle = 280'
51116-25	white	16' x 20 tracks/bundle = 320'
51120-25	white	20' x 20 tracks/bundle = 400'
\$4.53/ft.		

51116-65	brown	16' x 20 tracks/bundle = 320'
51116-90	silver	16' x 20 tracks/bundle = 320'
\$4.98/ft		

ASSEMBLED PRICING includes track, carriers, masters, brackets, cord and tension pulley. Indicate pinch pleat, Ripplefold*, accordiafold or cubicle. Please call for price if bends, curves or other specifications are needed.

\$182.62 for the first 4 feet, \$15.57/additional foot. Colors other than white, +10%. Freight is additional.

BREAK PACK PRICING - Prices with this designation indicate a 20% up charge for broken pack quantities.

APPLICATION	PLEAT STYLE	STACKBACK	MOUNTING	MAX WEIGHT
Cord Draw	Ripplefold*6" per width		Wall	4 lbs/ft
One or Two Way	Pinch Pleat. . . .7" per width		Ceiling	Depending on application
Bead chain available	Accordiafold. . . .5" per width			



CHILD SAFETY
PAGE 100



BEND/CURVE
PAGE 21

TRACKS - CCS

CCS Carriers



2114-25 60% fullness, 2 5/8" OC
2111-25 80% fullness, 2 3/8" OC
2112-25 100% fullness, 2 1/8" OC
2115-25 120% fullness, 1 7/8" OC
 Two-Piece Connected Snap Carrier w/ Square Base
 In plastic sleeve. Use 4 1/4" snap tape.
 \$1.10 ea.
 \$0.92 ea./roll of 500



52008-25
-65 Brown +10%
 Slim Line Klick Carrier
 Draperies hang to conceal track
 \$0.97 ea.
 \$0.80 ea./box of 250



52108-25
 Stop Carrier
 prevents slide back
 \$1.97 ea.
 \$1.64 ea./box of 100



52003-25
-65 Brown + 10%
 Economy Slide
 \$0.26 ea.
 \$0.22/box of 2000



52004-25
 Low Profile Ball Bearing
 \$1.36 ea.
 \$1.14 ea./box of 1000



52106-25
 Contract Klick Carrier
 w/ Stainless Hook
 use with grommets
 \$1.97 ea.
 \$1.64 ea./box of 100



52005-25
 Button Slide Carrier
 \$0.21 ea.
 \$0.18 ea./box of 1000



52105-25
 Button Slide Carrier
 w/ Hook
 \$0.65 ea.
 \$0.54 ea./box of 500

CCS Masters

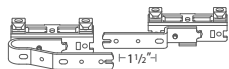

52508-25 Overlap R
52509-25 Underlap L
-65 Brown + 10%
Swivel Foot Multi-Functional Master
Use with bends and curves
\$11.55 ea.
\$9.62 ea./box of 100

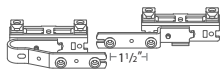

52508-25A Overlap R
52509-25A Underlap L
-65 Brown + 10%
Swivel Foot Multi-Functional Master w/ snaps
\$13.69 ea.
\$11.41 ea./box of 100



52410-25 Butt R
52409-25 Butt L
Standard Butt Master w/ snaps and for baton use
\$15.90 ea.
\$13.25 ea./box of 50

CCS Brackets



3001-25
-65 Brown + 10%
Regular Duty Ceiling
\$1.15 ea.
\$0.96 ea./box of 100



3002-25
Click On Ceiling with steel spring clip for use with drop ceilings
\$1.43 ea.
\$1.19 ea./box of 100



3003-25
-65 Brown + 10%
Heavy Duty Ceiling w/ Smart Klick
\$1.97 ea.
\$1.64 ea./box of 100



3006-25
Suspension Bracket Tube & Top
39" extension
\$111.34 ea. 10/box



3009-25
Suspension Bracket Klick System Clip
\$2.22 ea.
\$1.85 ea./box of 50



53202-25
-65 Brown + 10%
3" Smart Klick Wall Bracket w/ wide base adjusts 3"-4 1/2"
\$2.91 ea.
\$2.43 ea./box of 100

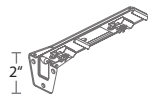

53206-25
-65 Brown + 10%
6" Smart Klick Double Wall Bracket w/ wide base adjusts 2 1/2"-4" & 6"-7 1/2"
\$4.78 ea.
\$3.98 ea./box of 50



3280-25
-65 Brown + 10%
3" Wall for Wood Poles heavy duty projection 2 1/2"
\$10.85 ea.
\$9.04 ea./box of 20

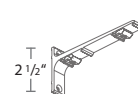

3281-25
-65 Brown + 10%
6" Double Wall for Wood Poles heavy duty projection 1 1/2", 5 1/2"
\$15.55 ea.
\$12.95 ea./box of 15



3284-25
-65 Brown + 10%
10" Triple Wall Bracket for Wood Poles, heavy duty projection 2", 6 5/8", 9 5/16"
\$28.84 ea.
\$24.03 ea./box of 10

CCS Other Components



3903-25
-65 Brown + 10%
Track Connector and key 3904-00
\$16.68 ea.
\$13.90 ea./box of 10



3901-25
-65 Brown + 10%
Ceiling Splice/Bracket
\$1.97 ea.
\$1.64 ea./box of 50



52804-25
CCS Return Insert with snap or hook
\$5.45 ea.
\$4.54 ea./box 25



52801-25
-65 Brown, -90 Silver + 10%
End Pulley 2 1/4" Reversible, use on right or left
\$10.85 ea.
\$8.38 ea./box 25



52801-25A Right End Pulley w/ Snap
52801-25B Left End Pulley w/ Snap
2 1/4" Reversible, for Ripplefold*
\$10.94 ea.
\$9.12 ea./box 25



52803-25
-65 Brown, -90 Silver + 10%
Small End Pulley 1 1/2" Reversible, use with Butt Masters and one-way draw
\$10.05 ea.
\$8.38 ea./box 25



52510-25
-65 Brown + 10%
Cord Connector
\$2.13 ea.
\$1.78 ea./box 100



2305-25
-65 Brown, -90 Silver + 10%
Twist On End Stop use with curved tracks
\$1.97 ea.
\$1.64 ea./box of 100



9004-25
3.2mm Cord 273.4 yds./roll
\$1.83/yd.
\$1.52/yd. for 273.4 yards



49500-00
Tension Device For child safety
\$7.67 ea.
\$6.39 ea./box 250



MTS® - Medi Track System

Aluminum extrusion, white, powder coated, lubricated for wall or ceiling mount.
For heavy duty applications at 8 lbs/ft.



51623-25 white 23' x 10 tracks/bundle = 230'
\$11.06/ft.

ASSEMBLED PRICING includes track, carriers, masters, brackets and 36" fiberglass baton. Indicate pinch pleat, Ripplefold*, accordiafold or cubicle.

\$194.94 for the first 4 feet, \$25.54/additional foot.
Freight is additional.

BREAK PACK PRICING - Prices with this designation indicate a 20% up charge for broken pack quantities.

APPLICATION	PLEAT STYLE	STACKBACK	MOUNTING	MAX WEIGHT
Hand Draw	Ripplefold 6" per width		Wall	8 lbs/ft
One or Two Way	Pinch Pleat 7" per width		Ceiling	
	Cubicle 5" per width		Can be spliced	

MTS Carriers



2004-25
Snap Carrier
for accordiafold
\$0.50 ea.
\$0.42 ea./box of 500



2114-25 60% fullness, 2 5/8" OC
2111-25 80% fullness, 2 3/8" OC
2112-25 100% fullness, 2 1/8" OC
2115-25 120% fullness, 1 7/8" OC
Two-Piece Connected Snap Carrier
w/ Square Base
In plastic sleeve. Use 4 1/4" snap tape
\$1.10 ea.
\$0.92 ea./roll of 500



52008-25
Slim Line Klick Carrier
Draperies hang to
conceal track
\$0.97 ea.
\$0.80 ea./box of 250



52003-25
Economy Slide
\$0.26 ea.
\$0.22/box of 2000



52004-25
Low Profile
Ball Bearing Carrier
\$1.36 ea.
\$1.14 ea./box of 1000



52110-25
CRS Carrier
UV-proof, synthetic material
\$0.42 ea.
\$0.35 ea./box of 500



2001-25
Klick Carrier
for pinch pleat
\$0.50 ea.
\$0.42 ea./box of 500



1 3/4" from
top of track
to bottom
of J hook.
2201-25
Klick Carrier
w/ Stainless Hook
Use with grommets
\$1.32 ea.
\$1.10 ea./box of 100



1 1/8"
52106-25
Contract Klick Carrier
w/ Stainless Hook
use with grommets
\$1.97 ea.
\$1.64 ea./box of 100



9001-25
J Hook, 1 1/8"
use with 52106
\$0.29 ea.
\$0.24 ea./box of 1,000



52005-25
Button Slide Carrier
\$0.21 ea.
\$0.18 ea./box of 1000



52105-25
Button Slide Carrier
w/ Hook
\$0.65 ea.
\$0.54 ea./box of 500



2202-25
Button Slide
w/ Breakaway Carrier
\$1.51 ea.
\$1.26 ea./bag of 5000

MTS Masters

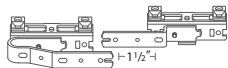

52508-25 Overlap R
52509-25 Underlap L
Swivel Foot Multi-Functional Master
Use with bends and curves
\$11.55 ea.
\$9.62 ea./box of 100

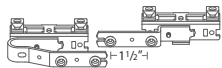

52508-25A Overlap R
52509-25A Underlap L
Swivel Foot Multi-Functional Master
w/ snaps
\$13.69 ea.
\$11.41 ea./box of 100



52410-25 Butt R
52409-25 Butt L
Standard Butt Master
w/ snaps and for baton use
\$15.90 ea.
\$13.25 ea./box of 50



88809-23-00 Overlap R
88809-24-00 Underlap L
Plastic Snap Master
\$11.50 ea.
\$9.58 ea./box of 25

MTS Brackets



3800-25
MTS Wall Bracket
To install the rod inside a frame
\$11.55 ea.
\$9.65 ea./box of 100



3006-25
Suspension Bracket Tube & Top
39" extension
\$111.34 ea. 10/box
3007-25
Suspension Bracket Insert Screw
\$7.20 ea.
\$6.00 ea./box of 100



3008-25
Suspension Bracket Top
\$40.18 ea.
\$33.48 ea./box of 25
3009-25
Suspension Bracket
Klick System Clip
\$2.22 ea.
\$1.85 ea./box of 50

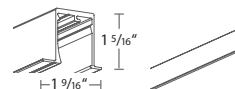

51723-25
Recess Profile, 23'
\$14.63/ft. **51724-25**
Recess Profile Fixing Strip, 23'
\$3.08/ft.



53914-25
Recess Profile Wedge
\$4.30 ea.
\$3.58 ea./box of 10



3001-25
Regular Duty Ceiling
\$1.15 ea.
\$0.96 ea./box of 100



3002-25
Klick On Ceiling
with steel spring clip
for use with drop ceilings
\$1.43 ea.
\$1.19 ea./box of 100



3003-25
Heavy Duty Ceiling
w/ Smart Klick
\$1.97 ea.
\$1.64 ea./box of 100



3901-25
Ceiling Splice/Bracket
\$1.97 ea.
\$1.64 ea./box of 50

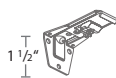

53202-25
3" Smart Klick Wall Bracket
w/ wide base
adjusts 3"-4 1/2"
\$2.91 ea.
\$2.43 ea./box of 100

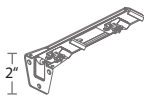

53206-25
6" Smart Klick Double Wall
Bracket w/ wide base
adjusts 2 1/2"-4" & 6"-7 1/2"
\$4.78 ea.
\$3.98 ea./box of 50

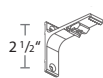

3280-25
3" Wall Bracket
heavy duty
projection 2 1/2"
\$10.85 ea.
\$9.04 ea./box of 20



3281-25
6" Double Wall Bracket
heavy duty
projection 1 1/2", 5 1/2"
\$15.55 ea.
\$12.95 ea./box of 15



3284-25
10" Triple Wall Bracket
heavy duty
proj 2", 6 5/8", 9 5/16"
\$28.84 ea.
\$24.03 ea./ box of 10

MTS Other Components



3801-25
MTS End Cap for Open End
\$5.70 ea.
\$4.75 ea./box of 200



3802-25
MTS End Cap for T-Connection
\$5.70 ea.
\$4.75 ea./box of 20



2305-25
Twist On End Stop
\$1.97 ea.
\$1.64 ea./box of 100



3803-25
MTS Track Connector
\$9.60 ea.
\$8.00 ea./box of 100



54110-25
36" Fiberglass Baton
w/ snap
\$6.89 ea.
\$5.74 ea./box of 100
See all batons p. 23



KS[®] - Klick System

Aluminum extrusion, powder coated, lubricated for wall or ceiling mount. For light to medium weight draperies – residential and cubicle use. Available in -25 white, -59 black, -65 brown, -90 silver, and -95 beige. Additionally, many colors are available for special order at a minimum of 10,000 ft.

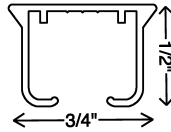

1013-25	white	13' 1" x 20 tracks/bundle = 262.46'
1016-25	white	16' 4" x 20 tracks/bundle = 328.08'
1019-25	white	19' 8" x 20 tracks/bundle = 393.70'
\$3.47/ft.		
1016-59	black	16' 4" x 20 tracks/bundle = 328.08'
1016-65	brown	16' 4" x 20 tracks/bundle = 328.08'
1016-90	silver	16' 4" x 20 tracks/bundle = 328.08'
1016-95	beige	16' 4" x 20 tracks/bundle = 328.08'
\$3.81/ft.		

ASSEMBLED PRICING Includes track, carriers, masters, brackets and 36" fiberglass baton. Indicate pinch pleat, Ripplefold*, accordiafold or cubicle. Please call for price if bends, curves or other specifications are needed.

\$102.19 for the first 4 feet, \$11.87/additional foot. Colors other than white, +10%. Freight is additional.

BREAK PACK PRICING - Prices with this designation indicate a 20% up charge for broken pack quantities.

APPLICATION	PLEAT STYLE	STACKBACK	MOUNTING	MAX WEIGHT
Hand Draw	Ripplefold 5" per width		Wall	3 lbs/ft
One or Two Way	Pinch Pleat. 6" per width		Ceiling	
	Cubicle. 5" per width		Can be spliced	



TRACKS - KS

KS Carriers



2001-25
-59 Black, -65 Brown,
-90 Silver + 10%
Klick Carrier
for pinch pleat
\$0.50 ea.
\$0.42 ea./box of 500



2002-25
-59 Black, -65 Brown,
-90 Silver + 10%
Shirrtape Carrier
\$0.48 ea.
\$0.40 ea./box of 500



2003-25
-59 Black + 10%
Stop Carrier
Klickable
Prevents slide back
\$0.91 ea.
\$0.76 ea./box of 250



2004-25
-59 Black + 10%
Snap Carrier
for accordiafold
\$0.50 ea.
\$0.42 ea./box of 500

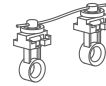

2114-25 60% fullness, 2 5/8" OC
2111-25 80% fullness, 2 3/8" OC
2112-25 100% fullness, 2 1/8" OC
2115-25 120% fullness, 1 7/8" OC
-59 Black + 10%
Two-Piece Connected Snap Carrier
w/ Square Base
In plastic sleeve. Use 4 1/4" snap tape
\$1.10 ea.
\$0.92 ea./roll of 500



52003-25
-65 Brown + 10%
Economy Slide
\$0.26 ea.
\$0.22/box of 2000



52004-25
Low Profile
Ball Bearing Carrier
\$1.36 ea.
\$1.14/box of 1000



1 3/4" from
top of track
to bottom
of J hook.
2201-25
-59 Black, -65 Brown + 10%
Klick Carrier
w/ Stainless Hook
Use with grommets
\$1.32 ea.
\$1.10/box of 100



52005-25
Button Slide Carrier
\$0.21 ea.
\$0.18 ea./box of 1000



52105-25
Button Slide Carrier
w/ Hook
\$0.65 ea.
\$0.54 ea./box of 500

KS Masters



2525-25 Overlap R
2526-25 Underlap L
-59 Black, -65 Brown + 10%
 Universal Low Profile Master
2527-25 Overlap L
2528-25 Underlap R
 \$11.50 ea.
 \$9.58 ea./box of 25



52410-25 Butt R
52409-25 Butt L
-59 Black + 10%
 Standard Butt Master
 w/ snaps and for baton use
 \$15.90 ea.
 \$13.25 ea./box of 100



2540-25 Overlap R
2541-25 Underlap L
 Low Profile Snap Master
 for straight track only
 \$6.55 ea.
 \$5.46 ea./box of 100

KS Brackets



3001-25
-59 Black, -65 Brown,
-90 Silver + 10%
 Regular Duty Ceiling
 \$1.15 ea.
 \$0.96 ea./box of 100



3002-25
 Klick On Ceiling
 with steel spring clip
 for use with drop ceilings
 \$1.43 ea.
 \$1.19 ea./box of 100



3003-25
-59 Black, -65 Brown,
-90 Silver + 10%
 Heavy Duty Ceiling
 w/ Smart Klick
 \$1.97 ea.
 \$1.64 ea./box of 100



3901-25
-59 Black, -65 Brown,
-90 Silver + 10%
 Ceiling Splice/Bracket
 \$1.97 ea.
 \$1.64 ea./box of 50



53202-25
-59 Black, -65 Brown,
-90 Silver + 10%
 3" Smart Klick Wall
 Bracket w/ wide base
 adjusts 3"-4 1/2"
 \$2.91 ea.
 \$2.43 ea./box of 100

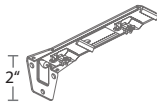

53206-25
-59 Black, -65 Brown,
-90 Silver + 10%
 6" Smart Klick Double Wall
 Bracket w/ wide base
 adjusts 2 1/2"-4" & 6"-7 1/2"
 \$4.78 ea.
 \$3.98 ea./box of 50

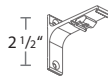

3280-25
-59 Black, -65 Brown,
-90 Silver + 10%
 3" Wall for Wood Poles
 heavy duty
 projection 2 1/2"
 \$10.85 ea.
 \$9.04 ea./box of 20

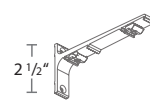

3281-25
-59 Black, -65 Brown + 10%
 6" Double Wall
 for Wood Poles
 heavy duty
 projection 1 1/2", 5 1/2"
 \$15.55 ea.
 \$12.95 ea./box of 15



3284-25
-65 Brown, -90 Silver + 10%
 10" Triple Wall
 for Wood Poles
 heavy duty
 projection 2", 6 5/8", 9 5/16"
 \$28.84 ea.
 \$24.03 ea./box of 10

KS Other Components



2309-25
-90 Silver + 10%
 End Stop Multifunctional
 \$1.11 ea.
 \$0.93 ea./box of 100



2304-65
 Twist End Stop with Cap
 \$1.37 ea.
 \$1.73 ea./box of 100



2306-59
 Twist End Stop with Cap
 \$2.26 ea.
 \$1.89 ea./box of 100



2305-25
-59 Black, -65 Brown,
-90 Silver + 10%
 Twist On End Stop
 \$1.97 ea.
 \$1.64 ea./box of 100



52307-90
 End Lock
 \$0.87 ea.
 \$0.73 ea./box of 100

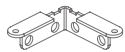

2308-25
 Return Plate
 reversible, 2 1/2" return
 \$7.43 ea.
 \$6.20 ea./box of 100



3905-25
-59 Black, -65 Brown,
-90 Silver + 10%
 Track Connector and key **3904-00**
 \$8.97 ea.
 \$7.47 ea./box of 50



54110-25
 36" Fiberglass Baton
 w/ snap
 \$6.89 ea.
 \$5.74 ea./box of 100
 See all batons p. 23



DS® - Design System

Elegant hand draw system for all types of medium weight draperies.
Aluminum extrusion, white, powder coated, lubricated for wall and ceiling mount.

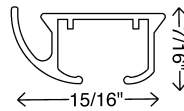

1116-25 white 16' 4" x 20 tracks/bundle = 326.7'
\$5.43/ft.

ASSEMBLED PRICING includes track, carriers, masters, brackets and 36" fiberglass baton. Indicate pinch pleat, Ripplefold*, accordiafold or cubicle.

\$104.80 for the first 4 feet, \$11.32/additional foot. Freight is additional.

BREAK PACK PRICING - Prices with this designation indicate a 20% up charge for broken pack quantities.

APPLICATION	PLEAT STYLE	STACKBACK	MOUNTING	MAX WEIGHT
Hand Draw	Ripplefold6" per width		Wall	3 lbs/ft
One or Two Way	Pinch Pleat7" per width		Ceiling	Depending on application
	Cubicle5" per width			
	Accordiafold5" per width		Can be spliced	

DS Components



2001-25
Klick Carrier for PP
\$0.50 ea.
\$0.42 ea./box of 500
2201-25
Klick Carrier w/ Hook
\$1.32 ea.
\$1.10/box of 100



2002-25
Shirrtape Carrier
\$0.48 ea.
\$0.40 ea./box of 500



2003-25
Stop Carrier
Klickable
Prevents slide back
\$0.91 ea.
\$0.76 ea./box of 250



2004-25
Snap Carrier
for accordiafold
\$0.50 ea.
\$0.42 ea./box of 500



2114-25 60% fullness, 2 5/8" OC
2111-25 80% fullness, 2 3/8" OC
2112-25 100% fullness, 2 1/8" OC
2115-25 120% fullness, 1 7/8" OC
Two-Piece Connected Snap Carrier w/ Square Base
In plastic sleeve. Use 4 1/4" snap tape.
\$1.10 ea.
\$0.92 ea./roll of 500



52003-25
Economy Slide
\$0.26 ea.
\$0.22/box of 2000



52005-25
Button Slide Carrier
\$0.21 ea.
\$0.18 ea./box of 1000



52105-25
Button Slide Carrier
w/ Hook
\$0.65 ea.
\$0.54 ea./box of 500



2525-25 Overlap R
2526-25 Underlap L
2527-25 Overlap L
2528-25 Underlap R
Universal Low Profile
\$11.50 ea.
\$10.54 ea./box of 25



2540-25 Overlap R
2541-25 Underlap L
Low Profile Snap Master
for straight track only
\$6.55 ea.
\$5.46 ea./box of 100



B8809-23-00 Overlap R
B8809-24-00 Underlap L
Plastic Snap Master
\$11.50 ea.
\$9.58 ea./box of 25



52410-25 Butt R
52409-25 Butt L
Standard Butt Master
w/ snaps
for use with baton
\$15.90 ea.
\$13.25 ea./box of 100



3001-25
Regular Duty Ceiling
\$1.15 ea.
\$0.96 ea./box of 100



3002-25
Klick On Ceiling
with steel spring clip
for use with drop ceilings
\$1.43 ea.
\$1.19 ea./box of 100



3003-25
Heavy Duty Ceiling
w/ Smart Klick
\$1.97 ea.
\$1.64 ea./box of 100

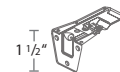

53202-25
3" Smart Klick
Wall Bracket w/ wide base
adjusts 3"-4 1/2"
\$2.91 ea.
\$2.43 ea./box of 100

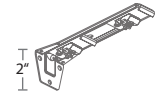

53206-25
6" Smart Klick Double
Wall Bracket w/ wide base
adjusts 2 1/2-4" & 6-7 1/2"
\$4.78 ea.
\$3.98 ea./box of 50

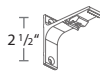

3280-25
3" Wall Bracket
heavy duty
projection 2 1/2"
\$10.85 ea.
\$9.04 ea./box of 20

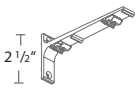

3281-25
6" Double Wall Bracket
heavy duty
projection 1 1/2", 5 1/2"
\$15.55 ea.
\$12.95 ea./box of 15



3284-25
10" Triple Wall Bracket
heavy duty
projection 2", 6 5/8",
9 5/16"
\$28.84 ea.
\$24.03 ea./box of 10



2305-25
Twist On End Stop
\$1.97 ea.
\$1.64 ea./box of 100



2310-25
DS End Cap w/ screw
\$1.89 ea.
\$1.58 ea./box of 10



54110-25
36" Fiberglass Baton
w/ snap
\$6.89 ea.
\$5.74 ea./box of 100
See all batons p. 23



DS XL® - Design System XL

An elegantly shaped track. Use as a standard hand draw system with ripplefold or pinch pleat carriers. The Forest Easy Flex System is a good match allowing for easily adjusted fold depth. Install the DSXL track without any visible brackets - works with both Klick brackets and swivel brackets.

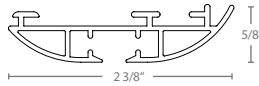

2119-25 white 19' 8" x 20 tracks/bundle = 393.7'
\$11.52/ft.

ASSEMBLED PRICING includes track, carriers, masters, brackets and 36" fiberglass baton. Indicate pinch pleat, Ripplefold*, accordiafold or cubicle.

\$223.04 for the first 4 feet, \$30.84/additional foot. Freight is additional.

BREAK PACK PRICING - Prices with this designation indicate a 20% up charge for broken pack quantities.

APPLICATION	PLEAT STYLE	STACKBACK	MOUNTING	MAX WEIGHT
Hand Draw	Ripplefold	6" per width	Wall	3 lbs/ft
One or Two Way	Pinch Pleat	7" per width	Ceiling	Depending on application
	Cubicle	5" per width		
	Accordiafold	5" per width		

DSXL Components



2001-25
Klick Carrier for PP
\$0.50 ea.
\$0.42 ea./box of 500
2201-25
Klick Carrier w/ Hook
\$1.32 ea.
\$1.10/box of 100



2002-25
Shirrtape Carrier
\$0.48 ea.
\$0.40 ea./box of 500



2003-25
Stop Carrier
Klickable
Prevents slide back
\$0.91 ea.
\$0.76 ea./box of 250



2004-25
Snap Carrier
for accordiafold
\$0.50 ea.
\$0.42 ea./box of 500



2114-25 60% fullness, 2 5/8" OC
2111-25 80% fullness, 2 3/8" OC
2112-25 100% fullness, 2 1/8" OC
2115-25 120% fullness, 1 7/8" OC
Two-Piece Connected Snap Carrier w/ Square Base
In plastic sleeve. Use 4 1/4" snap tape.
\$1.10 ea.
\$0.92 ea./roll of 500



52003-25
Economy Slide
\$0.26 ea.
\$0.22/box of 2000



52005-25
Button Slide Carrier
\$0.21 ea.
\$0.18 ea./box of 1000



52105-25
Button Slide Carrier
w/ Hook
\$0.65 ea.
\$0.54 ea./box of 500



2525-25 Overlap R
2526-25 Underlap L
2527-25 Overlap L
2528-25 Underlap R
Universal Low Profile Master
\$11.50 ea.
\$9.58 ea./box of 25

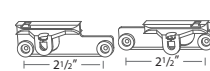

2540-25 Overlap R
2541-25 Underlap L
Low Profile Snap Master
for straight track only
\$6.55 ea.
\$5.46 ea./box of 100



B8809-23-00 Overlap R
B8809-24-00 Underlap L
Plastic Snap Master
\$11.50 ea.
\$9.58 ea./box of 25

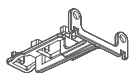

9040-25 Overlap R/L
FES Master
\$4.63 ea.
\$3.86/box of 25



2300-25
Klick On Ceiling Bracket
\$1.22 ea.
\$1.01/box of 200



2301-25
Wall Bracket w/ Swivel
\$54.49 ea.
\$45.41/box of 5



2400-25
DSXL End Cap
\$2.16 ea.
\$1.80/box of 20



54110-25
36" Fiberglass Baton
w/ snap
\$6.89 ea.
\$5.74 ea./box of 100
See all batons p. 23



RBS® - Roman Blind System

Most durable and functional roman blind hardware on the market. White aluminum extrusion, powder coated. Wall or ceiling mount. Integrated velcro tape.

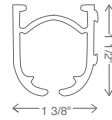

41019-25 white 19' x 10 tracks/bundle = 190'
\$6.84/ft.

RBS ASSEMBLED PRICING - please specify endless chain drop length, wall or ceiling mount, counterweights, control side, number of cord roll supports and any other components needed. Counterweights will be sent only upon request and at no extra charge.

\$118.61 for the first 3 feet, \$2.51/additional inch. Freight is additional.

BREAK PACK PRICING - Prices with this designation indicate a 20% up charge for broken pack quantities.



CHILD SAFETY
PAGE 100

MOTORIZED
PAGE 85

APPLICATION	SHADE STYLE	MOUNTING	MAX WEIGHT
Chain Operated	Roman, Balloon, etc.	Wall Ceiling Cannot be spliced	1:4 gear up to 18 lbs. 1:2 gear up to 14 lbs. 1:1 gear up to 10 lbs.

RBS Components

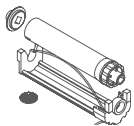

49003-25
Cord Roll Support w/ Cord
12' drop length
\$4.91 ea.
\$4.09 ea./box of 100

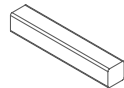

41119-90
19' Rod
aluminum 3/16" x 3/16"
\$2.42/ft.
\$2.02/ft. for bundle of 5

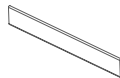

49005-25
Counterweight, 19'
aluminum 1" x 1/8"
\$2.24/ft.
\$1.79/ft. for bundle of 20



43202-25
Swivel Wall Bracket
\$2.05 ea.
\$1.71 ea./box of 100



43003-25
Swivel Ceiling Bracket
\$2.32 ea.
\$1.93 ea./box of 100

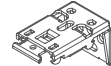

43033-25
Klick Wall Bracket
\$2.32 ea.
\$1.93 ea./box of 200



43034-25
Hidden Klick Multi Bracket
\$2.32 ea.
\$1.93 ea./box of 100

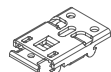

43004-25
Klick Ceiling Bracket
\$2.32 ea.
\$1.93 ea./box of 100



49008-25
Shade Leveler
\$0.50 ea.
\$0.42 ea./box of 1000



31116-25
Velcro Profile w/
Hook Tape, 13.1'
\$4.22/ft.
\$3.52/ft. for bundle of 20

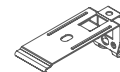

49090-25
Valance Bracket
attaches to velcro profile
\$2.66 ea.
\$2.22 ea./box of 50



49091-25
Valance Corners
\$3.88 ea.
\$3.23 ea./box of 250



39007-25
Velcro Tape
27 yds. per roll
\$25.19/roll



49006-25
Fiberglass Spines, 19'
3/16" diameter
\$0.56/ft.
\$0.40/ft. for bundle of 250



49014-25
Plastic Snap Ring
\$0.11 ea.
\$0.09 ea./box of 5000



49013-25
Plastic Ring Cord Guide
\$0.11 ea.
\$0.09 ea./box of 5000



49400-25
Shroud
73 yds. per roll
\$220.44/roll



49500-00
Tension Device
for child safety
\$7.67 ea.
\$6.39 ea./box of 100



Endless Chain, white
-90 Nickel (29"-69"), -95
Beige, -99 Ivory +10%
Drop lengths available:
49020-25 29" \$2.01 ea
49021-25 39" \$2.33 ea

49022-25 49" \$2.88 ea
49023-25 59" \$3.20 ea
49024-25 69" \$3.37 ea
49025-25 79" \$3.46 ea
49026-25 89" \$3.59 ea
49027-25 99" \$3.88 ea
100 pcs/bag



49126-25
Metal Ball Chain
500 ft. per roll
\$372.75/roll



76047-90
Metal Ball Chain Stopper
\$0.50 ea.

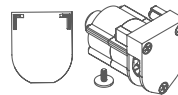

Control Unit w/ End
Cap & Retaining Ring
heavy duty, self-braking
42311-25
1:4 gear to 18 lbs.



42312-25
1:2 gear to 14 lbs.
42310-25
1:1 gear to 10 lbs.
\$15.23 ea.
\$12.69/box of 100



RBS XL® - Roman Blind System

White aluminum extrusion, powder coated. Wall or ceiling mount. Integrated velcro tape.

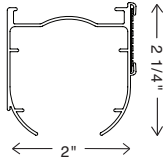

44019-25 white 19' x 10 tracks/bundle = 190'
\$10.08/ft.

RBS XL ASSEMBLED PRICING - please specify endless chain drop length, wall or ceiling mount, counterweights, control side, number of cord roll supports and any other components needed. Counterweights will be sent only upon request and at no extra charge.

\$144.08 for the first 4 feet, \$3.18/additional inch. Freight is additional.

BREAK PACK PRICING - Prices with this designation indicate a 20% up charge for broken pack quantities.



CHILD SAFETY
PAGE 100

APPLICATION	SHADE STYLE	MOUNTING	MAX WEIGHT
Chain Operated	Roman, Balloon, etc.	Wall Ceiling Cannot be spliced	1:4 gear up to 24 lbs.

RBS XL Components

<p>44003-25 RBS XL Cord Roll Support \$7.41 ea. \$6.17 ea./box of 100</p>	<p>41119-90 19' Rod aluminum 3/16" x 3/16" \$2.42/ft. \$2.02/ft. for bundle of 5</p>	<p>49005-25 Counterweight, 19' aluminum 1" x 1/8" \$2.24/ft. \$1.79/ft. for bundle of 20</p>	<p>44004-90 RBS XL Ceiling Bracket nickel plated \$3.37 ea. \$2.81 ea./box of 100</p>	<p>44033-90 RBS XL Wall Bracket nickel plated \$8.81 ea. \$7.34 ea./box of 100</p>	<p>31116-25 Velcro Profile w/ Hook Tape, 13.1' \$4.22/ft. \$3.52/ft. bundle of 20</p>
<p>49008-25 Shade Leveler \$0.50 ea. \$0.42 ea./box of 1000</p>	<p>49090-25 Valance Bracket attaches to velcro profile \$2.66 ea. \$2.22 ea./box of 50</p>	<p>49091-25 Valance Corners \$3.88 ea. \$3.23 ea./box of 250</p>	<p>39007-25 Velcro Tape 27 yds. per roll \$24.95/roll</p>	<p>49006-25 Fiberglass Spines, 19' 3/16" diameter \$0.56/ft. \$0.40/ft. bundle of 250</p>	<p>49014-25 Plastic Snap Ring \$0.11 ea. \$0.09 ea./box 5000</p>
<p>49013-25 Plastic Ring Cord Guide \$0.11 ea. \$0.09 ea./box of 5000</p>	<p>49400-25 Shroud 73 yds. per roll \$220.44/roll</p>	<p>49500-00 Tension Device for child safety \$7.67 ea. \$6.39 ea./box of 100</p>	<p>Endless Chain, white -95 Beige, -99 Ivory +10% Drop lengths available: 49020-25 29" \$2.01 ea 49021-25 39" \$2.33 ea 49022-25 49" \$2.88 ea</p>	<p>49023-25 59" \$3.20 ea 49024-25 69" \$3.37 ea 49025-25 79" \$3.46 ea 49026-25 89" \$3.59 ea 49027-25 99" \$3.88 ea 100 pcs/bag</p>	
<p>44311-25 RBS XL Control Unit w/ End Cap & Screw 1:4 gear to 24 lbs. \$20.17 ea. \$16.81 ea./box of 100</p>					



PS® - Panel System

A stylish alternative to vertical blinds that uses flat panels of fabric. Aluminum extrusion, white, powder coated, wall or ceiling mount.

5/8"  **31219-25**
2 channel 19' x 5 tracks p/bundle = 95' \$5.67/ft.

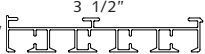

5/8"  **31319-25**
3 channel 19' x 5 tracks p/bundle = 95' \$7.12/ft.

5/8"  **31419-25**
4 channel 19' x 5 tracks p/bundle = 95' \$9.54/ft.

5/8"  **31519-25**
5 channel 19' x 5 tracks p/bundle = 95' \$11.40/ft.

ASSEMBLED PRICING includes track, brackets, and 36" fiberglass baton. Price may vary depending on specifications other than indicated. Counterweights will be sent only upon request and at no extra charge. Crating and freight are additional.

- 2 channel \$166.97/first 4' \$26.33/each additional ft.
- 3 channel \$188.65/first 4' \$31.08/each additional ft.
- 4 channel \$222.45/first 4' \$37.41/each additional ft.
- 5 channel \$258.71/first 4' \$41.11/each additional ft.

 **BREAK PACK PRICING**  - Prices with this designation indicate a 20% up charge for broken pack quantities.

APPLICATION	MOUNTING	MAX WEIGHT
Hand Draw	Wall	10 lbs/panel
One or Two Way	Ceiling	depending on application

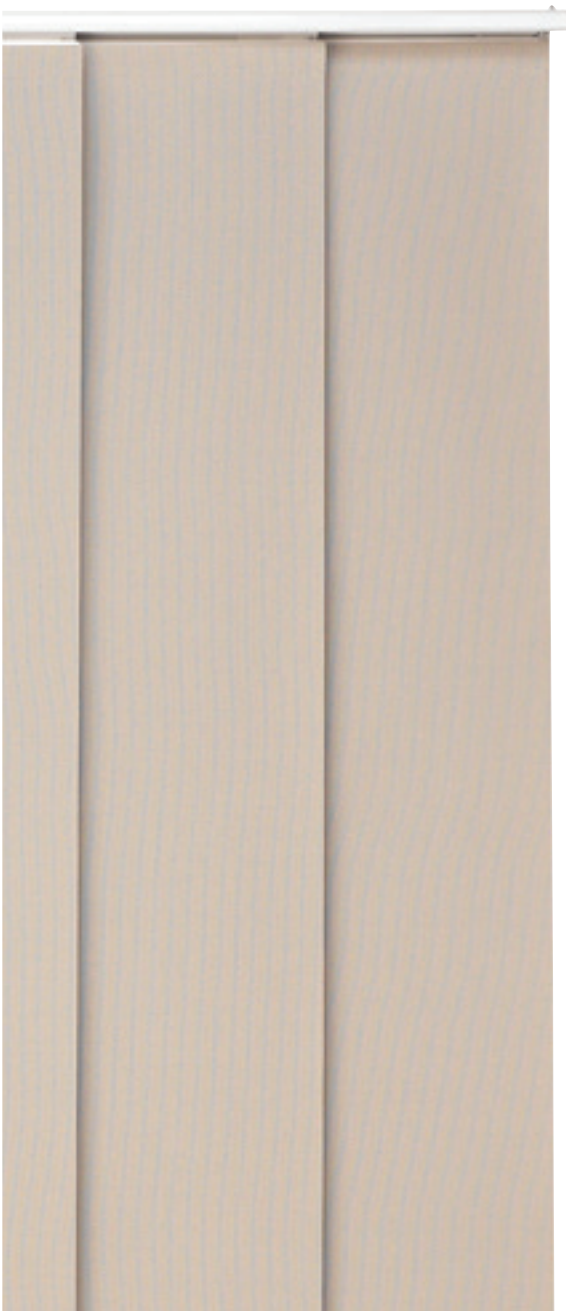

PS Components



32310-25
2-Channel End Cap
Requires end cap cover \$0.94 ea. \$0.78 ea./box of 500

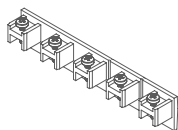

32311-25
3, 4 & 5-Channel End Cap
Requires end cap cover \$1.52 ea. \$1.27 ea./box of 300



32312-25
2-Channel Cover for End Cap & Pulley
\$0.56 ea. \$0.46 ea./box of 600

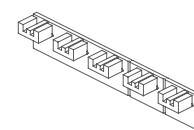

32309-25
3, 4 & 5-Channel Cover for End Cap & Pulley
\$0.97 ea. \$0.80 ea./box of 600



31116-25
Velcro Profile w/ Hook Tape, 13.1'
\$4.22/ft. \$3.52/ft. for bundle o

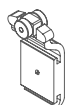

32007-25
Wheeled Carrier connects profile to track
\$1.26 ea. \$1.05 ea./box of 500



32510-25
Baton Adaptor use on leading panel
\$1.16 ea. \$0.97 ea./box of 500



33202-25
Catcher, T-Angle for all but stationary panel
\$0.56 ea. \$0.46 ea./box of 500



33203-25
Stopper, A-Angle for all but lead panel
\$0.56 ea. \$0.46 ea./box of 500



33204-25
L End Stop for stationary panel
\$0.56 ea. \$0.46 ea./box of 500



33209-25
Reverse L Stop for lead panel
\$0.56 ea. \$0.46 ea./box of 500



33208-25
Stationary Set Screw locks side panel in place
\$0.48 ea. \$0.40 ea./box of 500



33003-25
Swivel Ceiling Bracket for 2, 3 & 4 Channel
\$0.97 ea. \$0.80 ea./box of 200

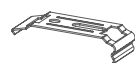

Klick On Ceiling Bracket/Splice
33002-25 2, 3 & 4 Channel
\$1.22 ea. \$1.01 ea./box of 200
33004-25 5 Channel
\$1.85 ea. \$1.54 ea./box of 200

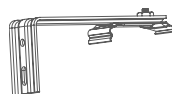

Wall Bracket
33005-25 2, 3 & 4 Channel
\$2.95 ea. \$2.46 ea./box of 200
33006-25 5 Channel
\$3.61 ea. \$3.01 ea./box of 200



39007-25
Velcro Tape 27 yds. per roll
\$24.95/roll

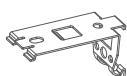

39090-25
Valance Bracket Does not fit 5-channel
\$2.69 ea. \$2.24 ea./box of 50



49091-25
Valance Corners To connect profile returns
\$3.88 ea. \$3.23 ea./box of 500



54110-25
36" Fiberglass Baton w/ snap
\$6.89 ea. \$5.74 ea./box of 100
See all batons p. 23

Custom Bending & Curving

Template at actual size is required. Bending and continuous curving is not available on poles and rods finished in Polished Chrome or with a Wood Foil.

Bend & Curve Tracks



CS – pages 3-4



CCS – pages 9-10



KS – pages 13-14



FMS – pages 81-82

Bend & Curve H-Rail Traversing Collections



DRESDEN TRAVERSING Collection
pages 39-40

Polished Chrome and Wood Foil finishes cannot be bent or curved.



DEVENTER CRS TRAVERSING Light Duty Collection
pages 43-44

Pricing

Per Bend: \$40.00

Continuous Curve: \$25.00

Additional crating charges apply.

Actual Size Template is Required

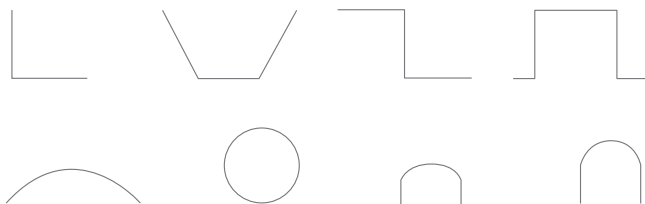

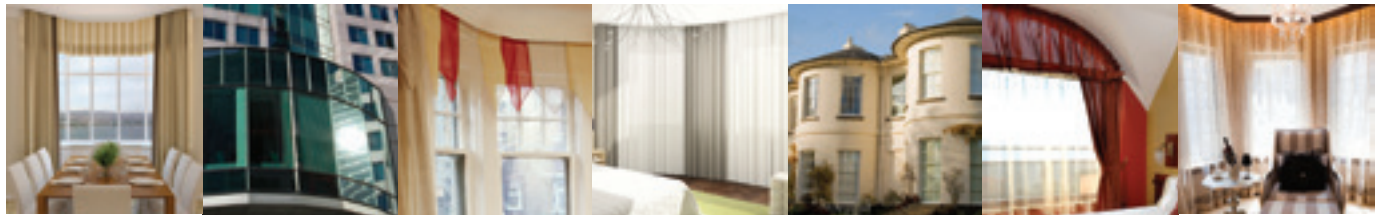

Curvers, Benders, Strips and Wheels for Forest Tracks



55001-00
CS Bender 8" Complete Set
Includes:
55300-00 CS 8" Bending Wheel
55302-00 CS Bending Strip Set
55100 CS Guide Wedge - Large
55101-00 CS Guide Wedge - Small
\$5,889.26 /set

55302-00
CS Bending Strip, 4'
\$121.40 ea.

55301-00
CS Bending Wheel
\$694.71 ea.

5305-00
CS/CCS/FMS Curving Wheel
\$1,778.69 ea.

55100-00
CS Bending Guide Wedge Large
55101-00
CS Bending Guide Wedge Small
*Call sales for pricing



55303-00
CCS Bending Strip, 4'
\$121.40 ea.

5305-00
CS/CCS/FMS Curving Wheel
\$1,778.69 ea.



5002-00
KS Bender Complete Set
Includes:
5302-00 KS Bending Strip
5307-00 KS Guide Wedge
\$1,422.96 /set

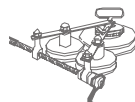

5003-00
KS Continuous Curver Set
\$997.20 ea.

5304-00
KS Curving Wheel
\$1,665.28 ea.

5302-00 KS Bending Strip, 2'
\$24.70 ea.
5303-00 KS Curving Strip, 10'
\$86.82 ea.

5307-00
KS Bending Guide Wedge
*Call sales for pricing



55306-00
FMS Bending Strip, 2'
\$55.27 ea.

55307-00
FMS Curving Strip, 23'
\$211.44 ea.

5305-00
CS/CCS/FMS Curving Wheel
\$1,778.69 ea.

Bending & Curving Strips and Wheels for Dresden and Deventer CRS H-Rail

55314-00
H-Rail Bending Strip
\$154.13

55310-00
H-Rail Bending Wheel
\$2,358.41 ea.

55313-00
H-Rail Curving Strip
\$107.57

55311-00
H-Rail Curving Wheel
\$1,097.76

55315-00
H-Rail Bending Guide Wedge Large
55316-00
H-Rail Bending Guide Wedge Small
*Call sales for pricing

Other Curving Products



5004-00
Electronic Continuous Curver
110 volt curver for accurate
& high output curving
\$18,278.52 ea.



55304-00
Curving Strip "T", 23'
\$121.40

Batons

Acrylic & Fiberglass Batons and Components

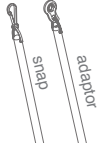

3/8" Fiberglass Baton
Must order screw separately

36"
54110-25 White w/ snap
54310-25 White w/ adaptor
\$6.89 ea. or \$5.74 ea./box 100

54110-59 Black w/ snap
54110-90 Silver w/ snap
\$12.04 ea. or \$10.03 ea./box 100

48"
54111-25 White w/ snap
54311-25 White w/ adaptor
\$9.16 ea. or \$7.63 ea./box 100

54111-59 Black w/ snap
54111-90 Silver w/ snap
\$14.35 ea. or \$11.96 ea./box 100

60"
54112-25 White w/ snap
54312-25 White w/ adaptor
\$14.38 ea. or \$11.98 ea./box 100

54112-59 Black w/ snap
54112-90 Silver w/ snap
\$18.81 ea. or \$15.68 ea./box 100

72"
54113-25 White w/ snap
54313-25 White w/ adaptor
\$16.63 ea. or \$13.86 ea./box 100

54113-59 Black w/ snap
54113-90 Silver w/ snap
\$21.84 ea. or \$18.20 ea./box 100



1/2" Acrylic Baton
Must order screw separately

54510-00 36" w/ snap
54710-00 36" w/ adaptor
\$9.86 ea.
\$8.21 ea./box of 100

54511-00 48" w/ snap
54711-00 48" w/ adaptor
\$19.28 ea.
\$16.06 ea./box of 100

54512-00 60" w/ snap
54712-00 60" w/ adaptor
\$21.60 ea.
\$18.00 ea./box of 100

54513-00 72" w/ snap
54713-00 72" w/ adaptor
\$28.84 ea.
\$24.03 ea./box of 100

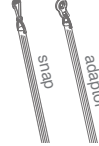

1/2" Acrylic Fluted Baton

54610-00 36" w/ snap
54810-00 36" w/ adaptor
\$9.86 ea.
\$8.21 ea./box of 100

54611-00 48" w/ snap
54811-00 48" w/ adaptor
\$19.28 ea.
\$16.06 ea./box of 100

54612-00 60" w/ snap
54812-00 60" w/ adaptor
\$21.60 ea.
\$18.00 ea./box of 100

54613-00 72" w/ snap
54813-00 72" w/ adaptor
\$28.84 ea.
\$24.03 ea./box of 100



ADA Acrylic Baton

54911-00 48" w/ adaptor
\$51.28 ea.
\$42.73 ea./box of 20

54912-00 60" w/ adaptor
\$59.38 ea.
\$49.48 ea./box of 20



9013-00
Baton Holder
clear acrylic
\$1.83 ea.



54001-16
Baton Snap
\$0.31 ea.



9015-00
Hex Head
Shoulder Screw
for baton w/ adaptor
\$0.33 ea.



54000-16
D-Ring
\$0.58 ea.

BREAK PACK PRICING

Components with this designation will have a 20% up charge for broken pack quantities.

Decorative Metal & Wood Batons



29MWAND-XX
40" Metal Baton
see all finishes p. 31
\$75.40 ea.



29AWAND-16
40" Round Metal Baton
Stainless Steel
\$79.38 ea.

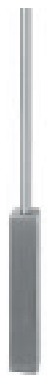

29SWAND-16
40" Square Metal Baton
Stainless Steel
\$83.57 ea.



29IWAND-XX
40" Wrought Iron Baton
see all finishes p. 35
\$67.11 ea.



19WWAND-XX
40" Wood Baton
see all finishes p. 58
\$17.76 ea. unfinished
\$21.87 ea. finished
\$40.72 ea. antiqued



19CWAND-XX
40" Modern Baton
see all finishes p. 58
\$17.76 ea. unfinished
\$21.87 ea. finished
\$40.72 ea. antiqued

Workroom Components



9009-00
Large Stiffener w/ grommet
Adjustable for ceiling or wall
\$1.05 ea.
\$0.87 ea./bag of 500



9011-00
Small Stiffener w/ grommet
For sheers
\$0.87 ea.
\$0.73 ea./bag 1000



9003-25
1" Snap Tape for Ripplefold*
4 1/4" OC spacing
\$4.74/yd.
\$3.95/yd. for 100 yard roll



9006-25
Snap Tape for accordiafold
7 1/2" OC spacing
\$3.76/yd.
\$3.13/yd. for 100 yard roll



9007-25
Snap Tape for accordiafold
8 1/2" OC spacing
\$3.76/yd.
\$3.13/yd. for 100 yard roll



9008-25
Snap Tape
for accordiafold
10" OC spacing
\$3.76/yd.
\$3.13/yd. for 100 yard roll

BREAK PACK PRICING - Components with this designation will have a 20% up charge for broken pack quantities.



FES® - Forest Easyflex System

Fold depth is fully customizable with Easyflex tape and carriers. Ceiling space required is equal to the spacing between the hook placement in the Easyflex tape.

Fits all Forest Tracks.

BREAK PACK PRICING - Components with this designation will have a 20% up charge for broken pack quantities.

FES Components



Wheeled Connected Snap
Carrier in plastic sleeve
2107-25 60%, 2 5/8" OC
2106-25 80%, 2 3/8" OC
2105-25 100%, 2 1/8" OC
2108-25 120%, 1 7/8" OC
\$1.36 ea.
\$1.14 ea./box of 500



Two-Piece Connected
Snap w/ Square Base
in plastic sleeve
2114-25 60%, 2 5/8" OC
2111-25 80%, 2 3/8" OC
2112-25 100%, 2 1/8" OC
2115-25 120%, 1 7/8" OC
\$1.10 ea.
\$0.92 ea./box of 500



52410-25 Butt R
52409-25 Butt L
Standard Butt Master
w/ snaps, for baton use
\$15.90 ea.
\$13.25 ea./box of 50



B8809-23-00 Overlap R
B8809-24-00 Underlap L
Plastic Snap Master
\$11.50 ea.
\$9.58 ea./box of 25



9037-25
Easyflex Hook
\$0.49 ea.
\$0.41 ea./box 500



9039-25
Easyflex End Hook
\$0.25 ea.
\$0.20 ea./box 1000

9036-00
Easyflex Tape
3" wide, 9/16" spacing
\$3.90 yd.
\$3.24 yd./roll 100 yds

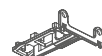

9040-25 Overlap R/L
FES Master
\$4.63 ea.
\$3.86 ea./box of 25

Dresden

3/4" & 1 1/8" Brass Pole Sets
1 1/8" Baton Draw Traversing
1 1/8" & 1 9/16" Cord Draw Traversing



MOTORIZED
PAGE 87

Lisbon

1 3/16" Brass Pole Sets



Aveiro

1 3/16" Steel Pole Sets



Porto

3/4" & 1 3/16"
Wrought Iron Pole Sets



Quality and style in
DECORATIVE METAL COLLECTIONS

Forest Decorative Metal Collections offer the perfect combination of style and functionality. From contemporary to traditional designs, these collections include hand drawn pole sets or traversing rail sets. The 1 1/8" Dresden Collection is also offered as a motorized system on pages 87-90.

Deventer 

1 1/8" Traversing Rod Sets



Frankfurt

1" Traversing Square Rail



Stuttgart

Flat Fascia, Traversing C,
Oval and Rectangle Rail Sets



Forest Pole Sets Overview

Dresden Collection

3/4" & 1 1/8" Brass Pole Sets

Pages 28-30



Lisbon Collection

1 3/16" Brass Pole Sets

Pages 31-32

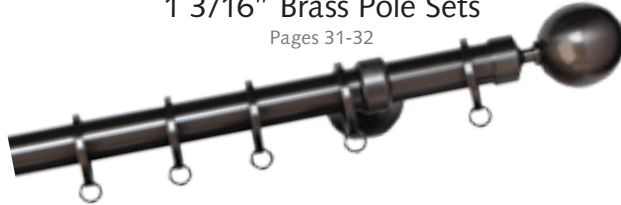

Aveiro Collection

1 3/16" Stainless Steel Pole Sets

Page 33-34



Porto Collection

3/4" & 1 3/16 Wrought Iron Pole Sets

Pages 35-36



Dresden Collection

3/4" Brass Pole Sets

Recommended weight is 4 lbs/ft. depending on application.



Available Finishes XX = finish color

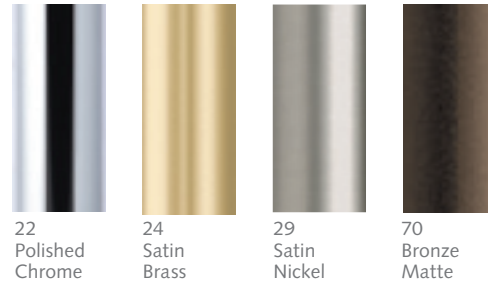

3/4" Dresden Components



B801-20-XX
3/4" Brass Pole, 16' 4"
\$22.04/ft.



B124020-XX
End Cap Finial
\$36.13 ea.

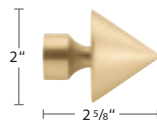

B3357-XX
Riva Finial
\$117.44 ea.

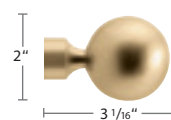

B3363-XX
Alassio Finial
\$145.24 ea.

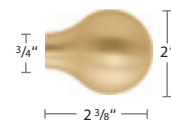

B3448-20-XX
Gota Finial
\$133.26 ea.



B3447-20-XX
Selva Finial
\$108.78 ea.



B124120-XX
Alea Finial
\$21.76 ea.

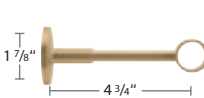

B11950-20-XX
Single Bracket
\$123.46 ea.

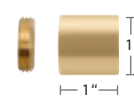

B122020-XX
Inside Mount Bracket
\$66.25 ea.

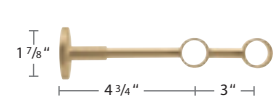

B11952-20-XX
Double Bracket
\$186.69 ea.

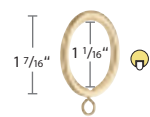

B125620-XX
Ring w/ Eyelet & Plastic Insert
\$7.60 ea.

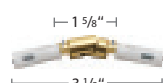

B122920-XX
Swivel Elbow
\$147.54 ea.



2020SPL-23
Splice
\$12.70 ea.

Dresden Collection

1 1/8" Brass Pole Sets with Finials or a French Return

Recommended weight is 4 lbs/ft. depending on application.



Available Finishes XX = finish color

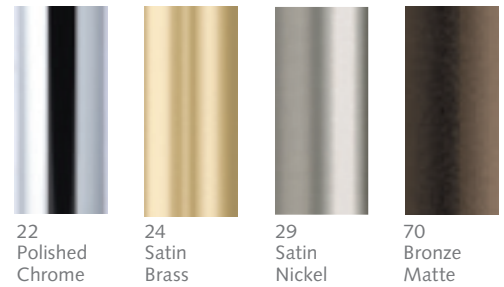

METAL - 1 1/8" Dresden Pole Sets

1 1/8" Dresden Pole, Brackets, Rings and Connectors



B801-28-XX
1 1/8" Brass Pole, 16' 4"
\$25.05/ft.



B11950-28-XX
Single Bracket
Wall or Ceiling
\$195.72 ea.

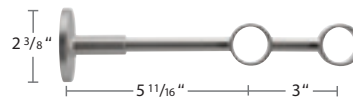

B11952-28-XX
Double Bracket
Wall
\$270.99 ea.



B11598-28-L-XX
B11598-28-R-XX
French Return
3 1/8" P
\$161.28 ea.

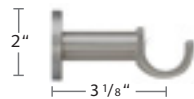

B400-80-XX
Support Bracket
for French Return
\$150.47 ea.



B11970-100-XX
Classic Single Bracket
Wall or Ceiling
\$147.54 ea.



B11970-2-100-XX
Classic Double Bracket
Wall
\$177.65 ea.



B122028-XX
Inside Mount Bracket
\$84.31 ea.

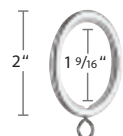

B125630-XX
Ring w/ Eyelet
Includes Plastic Insert
\$10.60 ea.

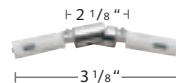

B122928-XX
Swivel Elbow
\$160.27 ea.



2030SPL-23
Splice
\$12.70 ea.

29 Satin Nickel Dresden Pole with French Return



22 Polished Chrome Dresden Pole with Ardea Finial and Socket



24 Satin Brass Dresden Pole with Pescara Finial



70 Bronze Matte Dresden Pole with Allesandria Finial

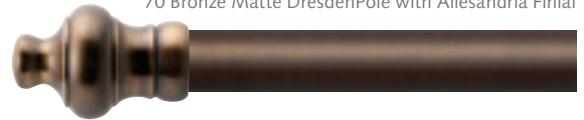

1 1/8" Dresden Finials

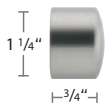

B124028-XX
End Cap Finial
\$42.16 ea.

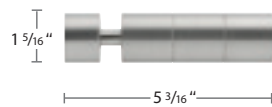

B690-XX
Pescara Finial
\$237.88 ea.

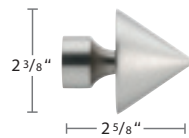

B3356-XX
Riva Finial
\$198.73 ea.

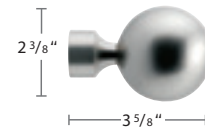

B3362-XX
Alasiao Finial
\$240.87 ea.

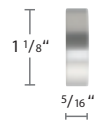

B124128-XX
Alea Finial
\$59.82 ea.

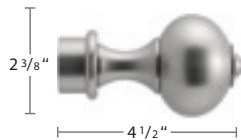

B650-XX
Verona Finial
\$326.34 ea.

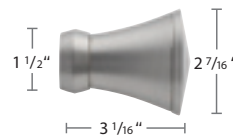

B610-XX
Napoli Finial
\$299.15 ea.

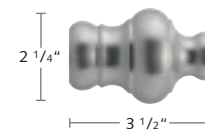

B129328-XX
Allesandria Finial
\$112.59 ea.

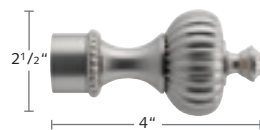

B660-XX
Roma Finial
\$422.05 ea.

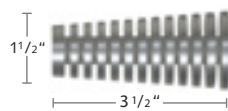

B3521-28-XX
Ischia Finial
\$206.72 ea.

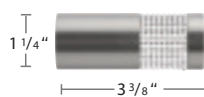

B315-28-XX
Largo Finial
\$338.71 ea.

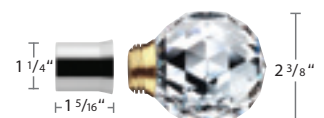

B3389-100
Ardea Finial
\$402.37 ea.
B3389/1-XX
Socket for Ardea Finial
\$80.91 ea.

Lisbon Collection

1 3/16" Brass Pole Sets with Finials or a French Return

Recommended weight is 4 lbs/ft. depending on application.



Available Finishes XX = finish color

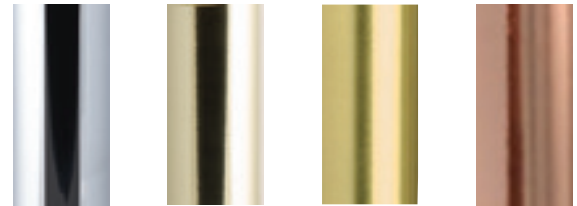

22 Polished Chrome 23 Polished Brass 24 Satin Brass 27 Rose Gold

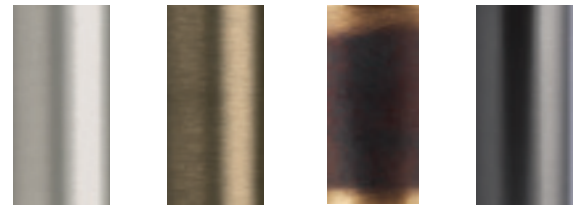

29 Satin Nickel 32 Antique Bronze 66 French Bronze 89 Graphite

METAL – 1 3/16" Lisbon Pole Sets

1 3/16" Lisbon Pole and Finials



2030SMP-XX
1 3/16" Brass Pole, 16'
\$34.44/ft.

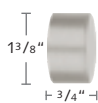

2130END-XX
End Cap Finial
\$20.65 ea.

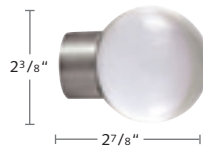

2130ACR-XX
Acrylic Ball Finial
\$65.27 ea.

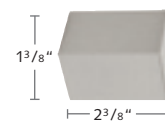

2130BLO-XX
Block Finial
\$51.79 ea.

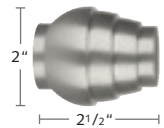

2130TIE-XX
Tier Finial
\$54.72 ea.

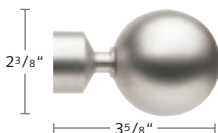

2130VEL-XX
Velate Finial
\$60.99 ea.

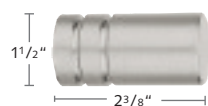

2130CIL-XX
Cilindro Finial
\$57.72 ea.

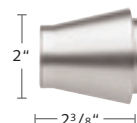

2130INC-XX
Inca Finial
\$57.98 ea.

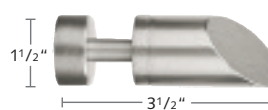

2130SLA-XX
Slant Finial
\$41.90 ea.

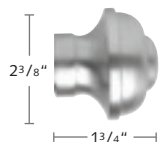

2130TOS-XX
Toscana Finial
\$43.22 ea.

22 Polished Chrome Lisbon Pole with French Return



24 Satin Brass Lisbon Pole with French Return



27 Rose Gold Lisbon Pole with Velate Finial



66 French Bronze Lisbon Pole with Toscana Finial



29 Satin Nickel Lisbon Pole with Velate Finial

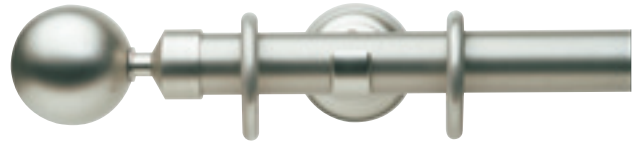

1 3/16" Lisbon Brackets, Rings, Splice, Baton and Holdback

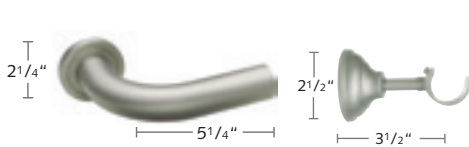

2230FRE-XX
French Return
Wall Bracket, 3 1/2" P
\$63.58 ea.

2230TOL-XX
Toledo Open
Wall Bracket
\$52.12 ea.



2230CIR-XX
Irati Closed
Ceiling Bracket
\$54.03 ea.

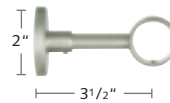

2230IRA-XX
Irati Closed
Wall Bracket
\$61.91 ea.

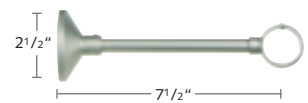

2230EVI-XX
Viana Extended Closed
Wall Bracket
\$56.99 ea.

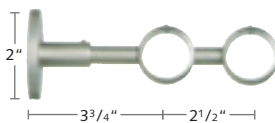

2230DIR-XX
Double Irati
Wall Bracket
Not for use w/ grommets
\$67.53 ea.



2230OIM-XX
Open Inside Mount
Wall Bracket
\$29.52 ea.

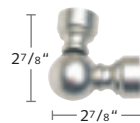

2130SWI-XX
Swivel Corner
Connector
\$68.82 ea.

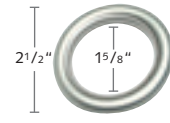

2330SHR-XX
Plastic Lined
Smooth Hollow Ring
w/ Clip-on Eyelet
\$5.12 ea.



2330FRI-XX
Flat Ring
\$9.65 ea.



2030SPL-23
Pole Splice
\$12.70 ea.



29MWAND-XX
Metal Control Baton 40"
\$75.40 ea.
See all batons p. 23

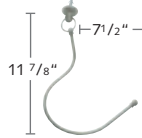

26SWING-XX
Swing Holdback
\$72.64 ea.

Aveiro Collection

1 3/16" Stainless Steel Pole Sets

Recommended weight is 4 lbs./ft. depending on application.



Available Finishes XX = finish color



METAL – 1 3/16" Aveiro Pole Sets

1 3/16" Aveiro Pole & Finials



2030SMP-XX
1 3/16" Stainless Pole, 16'
A304, 0.8mm
\$31.34/ft.

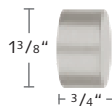

2130END-XX
End Cap Finial
\$20.65 ea.

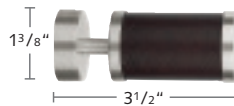

2130CLM-16 Round Brn
2130CLB-16 Round Blk
only in -16 Stainless Steel
\$88.94 ea.

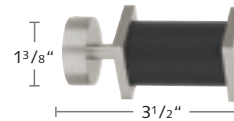

2130CUM-16 Square Brn
2130CUB-16 Square Blk
only in -16 Stainless Steel
\$88.66 ea.

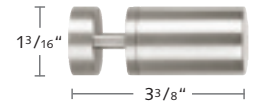

2130ROL-XX
Steel Rollend Finial
\$67.21 ea.

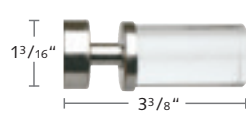

2130ROL-00 Stainless
2130ROL-25c, 87c, 88c
Clear Rollend Finial
\$78.07 ea.



2130ACR-XX
Acrylic Ball Finial
\$65.27 ea.

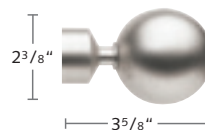

2130VEL-XX
Velate Finial
\$60.99 ea.

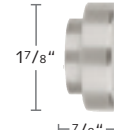

2130POP-XX
Pop Finial
\$50.01 ea.

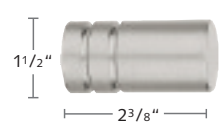

2130CIL-XX
Cilindro Finial
\$57.72 ea.

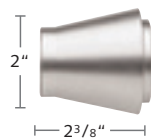

2130INC-XX
Inca Finial
\$57.98 ea.

87 Bronze Brilliant Aveiro Pole with French Return

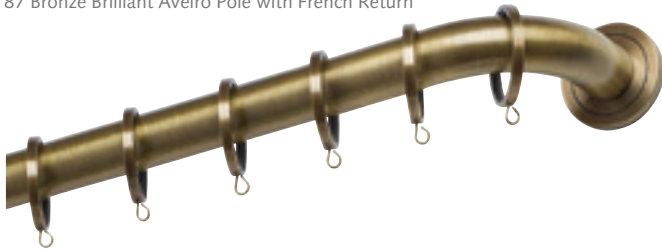

16 Stainless Steel Aveiro Pole with Square Black Finsel



16 Stainless Steel Aveiro Pole with End Cap Finsel



16 Stainless Steel Aveiro Pole with Clear Rollenbild Finsel

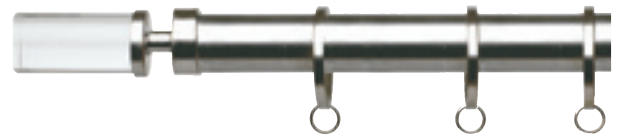

1 3/16" Aveiro Brackets, Ring, Splice and Batons



2230FRE-XX
French Return, 3 1/2" P
\$63.58 ea.

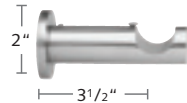

2230CYL-XX
Cylinder Wall Bracket
\$84.64 ea.

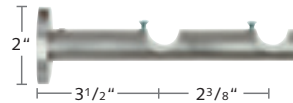

2230DCB-XX
Cylinder Double Wall Bracket
Not for use w/ grommets
\$138.39 ea.

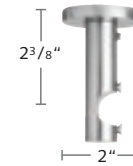

2230CEI-XX
Cylinder Ceiling Bracket
\$93.89 ea.

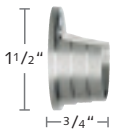

2230OIM-XX
Open Inside Mount
Bracket
\$29.52 ea.

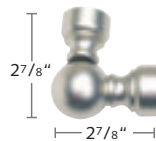

2130SWI-XX
Swivel Corner
Connector
\$68.82 ea.

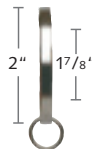

2330FRI-XX
Flat Ring
w/ Plastic Insert
\$9.65 ea.



2030SPL-23
Pole Splice
\$12.70 ea.



29AWAND-16
Round Baton 40"
\$79.38 ea.
29SWAND-16
Square Baton 40"
\$83.57 ea.

See all batons p. 23

Porto Collection

3/4" & 1 3/16 Wrought Iron Pole Sets

Recommended weight is 4 lbs/ft. depending on application.



Available Finishes XX = finish color



33
Black Silver



35
Grey Copper



37
Sand Gold

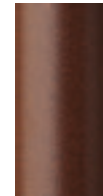

38
Rust



40
Graphite Rust



59
Black

3/4" Porto Wrought Iron Components



2020SIR-XX
3/4" Wrought Iron Pole, 13'
\$7.07/ft.

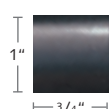

2120IEN-XX
End Cap Finial
\$10.65 ea.

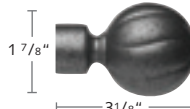

2120BOL-XX
3/4" Bola Finial
\$30.59 ea.

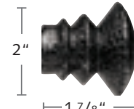

2120EVE-XX
3/4" Everest Finial
\$28.75 ea.



2120BER-XX
3/4" Berry Finial
\$19.33 ea.



2120CAR-XX
3/4" Caracola Finial
\$30.58 ea.

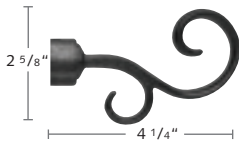

2120TRO-XX
3/4" Troia Finial
\$21.38 ea.



2120MAR-XX
3/4" Marte Finial
\$19.33 ea.



2220ILA-XX
Inside Mount Bracket
\$15.01 ea.



2220CEI-XX
Ceiling Bracket
\$24.71 ea.

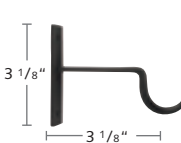

2220YOR-XX
York Single Open
Bracket
\$25.97 ea.

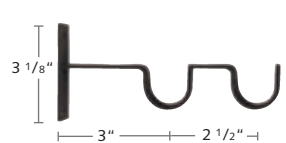

2220DYO-XX
York Double Open Bracket
\$34.62 ea.

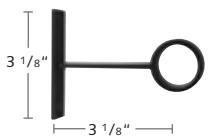

2220CYR-XX
York Single Closed
Bracket
\$28.58 ea.

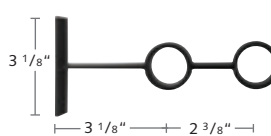

2220DCY-XX
York Double Closed
Bracket
\$38.08 ea.



2120SWI-XX
Swivel Corner
Connector
\$53.37 ea.

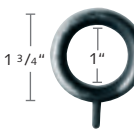

2320IRI-XX
Smooth Ring
w/ Plastic Insert
\$4.07 ea.



2020SPL-23
Pole Splice
\$12.70 ea.



29IWAND-XX
Iron Control Baton
Length: 40"
\$67.11 ea.
See all batons p. 23

METAL - 3/4" Porto Wrought Iron Pole Sets

37 Sand Gold Porto Pole with Caracola Finial



35 Grey Copper Porto Pole with Bola Finial



38 Rust Porto Pole with Berry Finial



40 Graphite Rust Porto Pole with Troia Finial

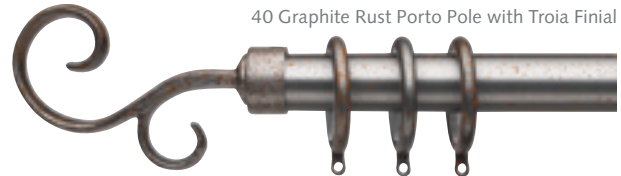

1 3/16" Porto Wrought Iron Components



2130SIR-XX
1 3/16" Wrought Iron Pole, 13'
\$9.58/ft.

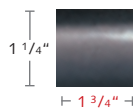

2130IEN-XX
1 3/16" End Cap Finial
\$12.12 ea.

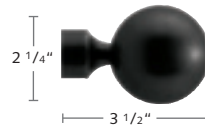

2130BAL-XX
1 3/16" Ball Finial
\$52.97 ea.

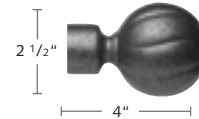

2130BOL-XX
1 3/16" Bola Finial
\$52.98 ea.

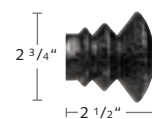

2130EVE-XX
1 3/16" Everest Finial
\$31.95 ea.

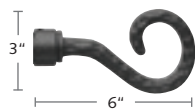

2130BER-XX
1 3/16" Berry Finial
\$21.48 ea.

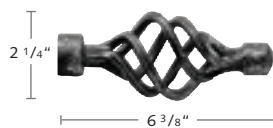

2130CAR-XX
1 3/16" Caracola Finial
\$55.31 ea.

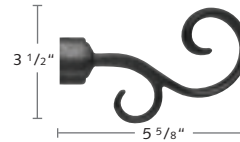

2130TRO-XX
1 3/16" Troia Finial
\$23.75 ea.



2130MAR-XX
1 3/16" Marte Finial
\$21.48 ea.



2230FRT-XX
French Return Bracket
3 3/8" P
\$32.08 ea.



2230ILA-XX
Lateral Bracket
\$15.98 ea.



2230CEI-XX
Ceiling Bracket
\$25.16 ea.

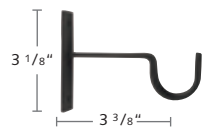

2230YOR-XX
York Single Open Bracket
\$25.97 ea.

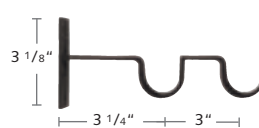

2230DYO-XX
York Double Open Bracket
\$34.62 ea.

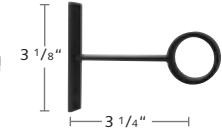

2230CYR-XX
York Single Closed Bracket
\$28.58 ea.

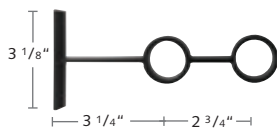

2230DCY-XX
York Double Closed Bracket
\$38.08 ea.



2130SWI-XX
Swivel Corner Connector
\$84.50 ea.

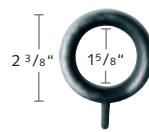

2330IRI-XX
Smooth Ring w/ Plastic Insert
\$8.05 ea.



2030SPL-23
Pole Splice
\$12.70 ea.



29IWAND-XX
Iron Control Baton
Length: 40"
\$67.11 ea.
See all batons p. 23

Forest Traversing Sets Overview

Dresden Baton Draw Traversing

1 1/8" Brass
Pages 39-40



Dresden Cord Draw Traversing *NEW SIZE!*

1 1/8" and 1 9/16" Brass
Pages 41-42

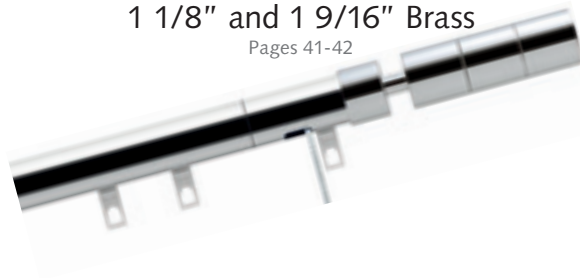

Deventer CRS® Traversing

1 1/8" Aluminum
Pages 43-44



Frankfurt Square Rail Traversing

1" Brass
Pages 45



Forest Traversing Sets Overview

Stuttgart Flat Fascia for Traversing *NEW!*

Aluminum

Page 46



Stuttgart Rectangle Rail Traversing

1 5/8" Brass

Page 47



Stuttgart C Rail Traversing

2 3/4" Stainless Steel

Page 48

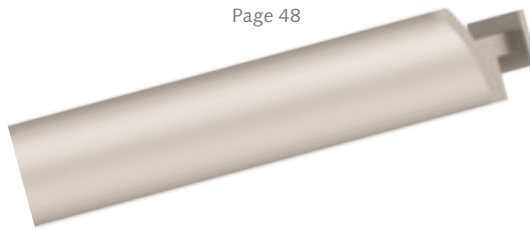

Stuttgart Oval Rail Traversing

1 1/2" & 2 3/4" Brass

Page 49-50



Dresden Traversing Collection

1 1/8" Baton Draw Sets

Recommended weight is 4 lbs/ft. depending on application.



ASSEMBLED PRICING includes rail, end cap finial, carriers, end stop, masters, single brackets and 36" fiberglass baton (see all batons p. 93 of Appendix). Indicate pinch pleat or Ripplefold*. Double sets are available.

\$650.38 for the first 4 feet, \$99.20/additional foot. Freight is additional.

BREAK PACK PRICING - Components with this designation will have a 20% up charge for broken pack quantities.

Bracket Count: Up to 60" = 2 brackets 121-180" = 4 brackets
61-120" = 3 brackets 181-240" = 5 brackets

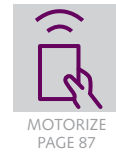

1 1/8" Traversing Dresden Finials & French Return

<p>B808-28-XX/XXX 1 1/8" Aluminum H-Rail, 19' \$30.87/ft. foiled 222, 223, 224 \$25.73/ft. all other finishes</p>	<p>B124028-XX End Cap Finial \$42.16 ea.</p>	<p>B3356-XX Riva Finial \$198.73 ea.</p>	<p>B690-XX Pescara Finial \$237.88 ea.</p>	<p>B3362-XX Alassio Finial \$240.87 ea.</p>
<p>B124128-XX Alea Finial \$59.82 ea.</p>	<p>B650-XX Verona Finial \$326.34 ea.</p>	<p>B610-XX Napoli Finial \$299.15 ea.</p>	<p>B129328-XX Alessandria Finial \$112.59 ea.</p>	<p>B660-XX Roma Finial \$422.05 ea.</p>
<p>B3521-28-XX Ischia Finial \$206.72 ea.</p>	<p>B315-28-XX Largo Finial \$338.71 ea.</p>	<p>B3389-100 Ardea Finial must use with socket \$402.37 ea.</p>	<p>B3389/1-XX Socket for Ardea Finial \$80.91 ea.</p>	<p>B11598-28-L-XX B11598-28-R-XX French Return, 3 1/8" P \$153.59 ea.</p>

METAL – Dresden Traversing

223 Oak Foil Rail with 29 Satin Nickel Alassio Finial



70 Bronze Matte Rail with 70 Bronze Matte Roma Finial



22 Polished Chrome Rail with Ardea Finial and Socket



Available Finishes XX/XXX = finish color



22 Polished Chrome



24 Satin Brass



29 Satin Nickel



70 Bronze Matte



59 Black



222 Beech Rail Only



223 Oak Rail Only



224 Walnut Rail Only

1 1/8" Traversing Dresden Brackets, Carriers, Masters and Other Components

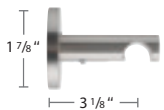

B11670-XX
Single Bracket
\$132.49 ea.



B11670-120-XX
Single Bracket
-22 Polished Chrome,
-29 Satin Nickel and -59 Black only
\$140.71 ea.

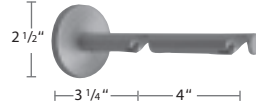

B11672-190-XX
Double Bracket
\$159.59 ea.

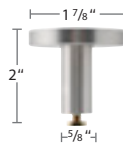

B11873-50-XX
Ceiling Bracket
\$96.35 ea.

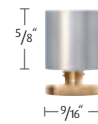

B11873-15-XX
Ceiling Bracket.
5/8" Extension
\$51.19 ea.

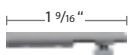

B11592-00
Flush Ceiling Bracket
\$21.90 ea.



2107-25 60% fullness, 2 5/8" OC
2106-25 80% fullness, 2 3/8" OC
2105-25 100% fullness, 2 1/8" OC
2108-25 120% fullness, 1 7/8" OC
-59 Black + 10%
Wheeled Connected Snap Carrier
in plastic sleeve
\$1.36 ea.
\$1.14 ea./roll of 500



52002-25
-59 Black, -65 Brown + 10%
Slim Line Ball Bearing Carrier
\$0.61 ea.
\$0.51 ea./box of 1000



V799-2-00
End Stop
\$0.80 ea.
\$0.66 ea./box of 100



B8809-23-00 Overlap R
B8809-24-00 Underlap L
-59 Black + 10%
Plastic Snap Master
\$11.50 ea.
\$9.58 ea./box of 25

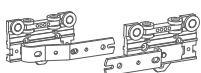

52502-25 Overlap R
52504-25 Underlap L
Standard Multi-Functional Master
Use stiffener w/ exposed baton
or hooks w/ hidden baton
\$6.55 ea.
\$5.46 ea./box of 100

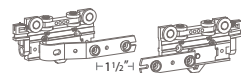

52502-25A Overlap R
52504-25A Underlap L
Standard Multi-Functional
Master w/ snaps
\$7.94 ea.
\$6.62 ea./box of 100



52411-25A Butt R
52412-25A Butt L
Wheeled Butt Master
w/snap adaptor
Designed for hidden baton
\$28.09 ea.
\$23.41 ea./box of 50



B122928-XX
Swivel Elbow
\$160.27 ea.



2551-25
Small Extension Arm
\$3.90 ea.
\$3.24 ea./box of 50

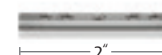

B899-3-00
Rail Connector
\$17.83 ea.

Dresden Corded Traversing Collection

1 1/8" & 1 9/16" Cord Draw Brass Pole Sets

Recommended weight is 4 lbs/ft. depending on application.

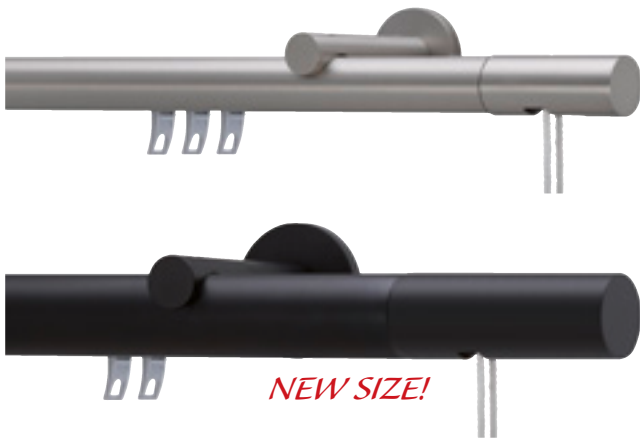

Available Finishes XX = finish color

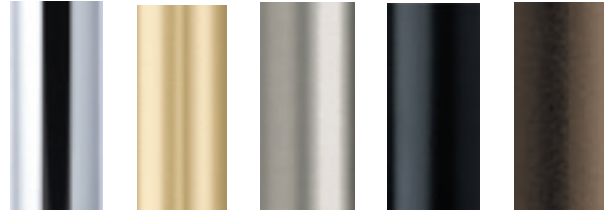

22 Polished Chrome
24 Satin Brass
29 Satin Nickel
59 Black
70 Matte Bronze

ASSEMBLED PRICING includes rail, cord pulley in finished housing (finials are optional for 1 1/8" and must be ordered separately), Klick carriers, masters, single brackets and child safety components. Freight is additional.

1 1/8" Corded Dresden - \$841.72 for the first 4 feet, \$104.85/additional foot.
1 9/16" Corded Dresden - \$1,042.05 for the first 4 feet, \$106.57/add'l foot.

Double sets are available. Please call sales for a quote, 866-823-3894.

Bracket Count:

Up to 60" = 2 brackets
61-120" = 3 brackets
121-180" = 4 brackets
181-240" = 5 brackets

BREAK PACK PRICING - Components with this designation will have a 20% up charge for broken pack quantities.



CHILD SAFETY
PAGE 100

1 1/8" Dresden Corded Components **FINIALS ARE OPTIONAL, NOT REQUIRED AND SHOULD BE ORDERED SEPARATELY.**



B809-28-XX
1 1/8" Brass Rail for Cord Draw
19' 7"
\$43.37/ft.



B11687-XX
Cord Pulley in finished housing
Finial not required
\$81.31 ea.



B124028-XX
End Cap Finial
\$42.16 ea.

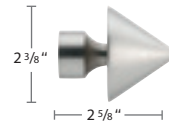

B3356-XX
Riva Finial
\$198.73 ea.

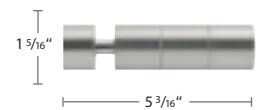

B690-XX
Pescara Finial
\$237.88 ea.

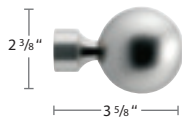

B3362-XX
Alassio Finial
\$240.87 ea.



B650-XX
Verona Finial
\$326.34 ea.



B610-XX
Napoli Finial
\$299.15 ea.

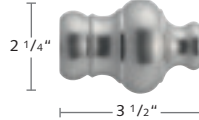

B129328-XX
Allessandria Finial
\$112.59 ea.

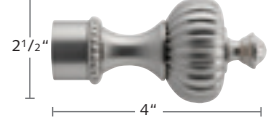

B660-XX
Roma Finial
\$422.05 ea.

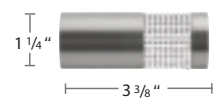

B315-28-XX
Largo Finial
\$338.71 ea.



B3389-100
Ardea Finial
must use with socket
\$402.37 ea.

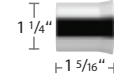

B3389/1-XX
Socket for Ardea Finial
\$80.91 ea.

1 1/8" Dresden Corded Components, continued

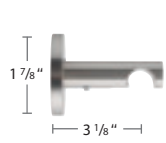

B11670-XX
Single Bracket
\$132.49 ea.

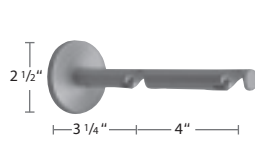

B11672-190-XX
Double Bracket
\$159.59 ea.

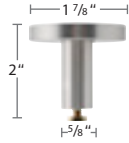

B11873-50-XX
Ceiling Bracket
\$96.35 ea.

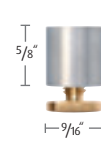

B11873-15-XX
Ceiling Bracket.
5/8" Extension
\$51.19 ea.

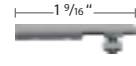

B11592-00
Flush Ceiling Bracket
\$21.90 ea.

1 9/16" Dresden Corded Components **CHOOSE A SATIN NICKEL OR BLACK FINISH, NO FINIALS AVAILABLE**

NEW SIZE!



B809-40-29, 59
1 9/16" Brass Rail for Cord Draw
19' 7"
\$47.29 ea.



B11687-40-29, 59
Cord Pulley in finished housing
\$134.67 ea.

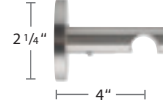

B40970-29, 59
Single Wall Bracket
\$142.65 ea.

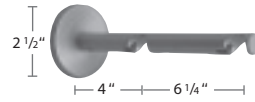

B40972-29, 59
Double Wall Bracket
\$174.35 ea.

Common Components - 1 1/8" & 1 9/16" Dresden Corded

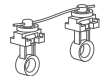

2114-25 60% fullness, 2 5/8" OC
2111-25 80% fullness, 2 3/8" OC
2112-25 100% fullness, 2 1/8" OC
2115-25 120% fullness, 1 7/8" OC
-59 Black +10%
Two-Piece Connected Snap Carrier
w/ Square Base, In plastic sleeve
use 4 1/4" snap tape
\$1.10 ea.
\$0.92 ea./roll of 500



52009-25
Ball Bearing Carrier
\$1.36 ea.
\$1.14 ea./roll of 250



52008-25
-59 Black, -65 Brown +10%
Slim Line Klick Carrier
Draperies hang to
conceal track
\$0.97 ea.
\$0.80 ea./box of 250

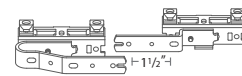

52508-25 Overlap R
52509-25 Underlap L
-59 Black + 10%
Cord Multi-Functional
Master
\$11.55 ea.
\$9.62 ea./box of 100

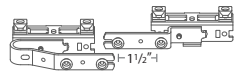

52508-25A Overlap R
52509-25A Underlap L
-59A Black + 10%
Cord Multi-Functional Master
w/ snaps
\$13.69 ea.
\$11.41 ea./box of 100



B8809-23-00 Overlap R
B8809-24-00 Underlap L
-59 Black + 10%
Plastic Snap Master
\$11.50 ea.
\$9.58 ea./box of 25



9004-25
3.2mm Cord
273.4 yds./roll
\$1.83/yd.
\$1.52/yd. for 273.4 yds



2805-25
Cord Connector
Connects cord to master
\$2.09 ea.
\$1.74 ea./box 100



49500-00
Tension Device
for child safety
\$7.67 ea.
\$6.39 ea./box 250

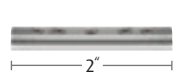

B899-3-00
Rail Connector
\$17.83 ea.



2551-25
Small Extension Arm
\$3.90 ea.
\$3.24 ea./box of 50

Deventer CRS® Traversing Collection

1 1/8" Light Duty H-Rail

Recommended weight is 3 lbs/ft. depending on application.



Available Finishes XX = finish color

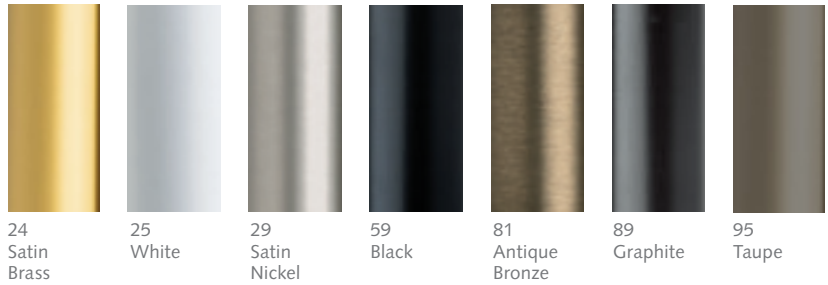

ASSEMBLED PRICING includes rail, end cap finial, carriers, end stop, masters, brackets and 36" fiberglass baton (see all batons p. 23). Indicate pinch pleat or Ripplefold.

\$517.29 for the first 4 feet, \$64.06/additional foot. Freight is additional.

Double sets are available. Please call sales for a quote, 866-823-3894.

Bracket Count:

Up to 60" = 2 brackets 121-180" = 4 brackets
61-120" = 3 brackets 181-240" = 5 brackets

BREAK PACK PRICING - Components with this designation will have a 20% up charge for broken pack quantities.



1 1/8" Deventer CRS Brackets



51419-XX
1 1/8" Aluminum CRS Rail, 19'
\$14.40/ft

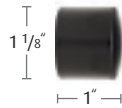

52430-XX
CRS End Cap Finial
\$36.07 ea. 10/box

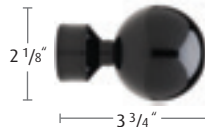

52431-XX
CRS Ball Finial
\$75.62 ea. 10/box

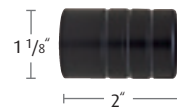

52432-XX
CRS Notched Finial
\$41.65 ea. 10/box



53401-XX
Single Bracket
3" P
\$52.14 ea. 2/box



53402-XX
Extended Single Bracket
4 3/4" P
\$68.64 ea. 2/box



53406-XX
Double Bracket
6" P
Do not use with Ripplefold
\$98.51 ea. 2/box



53407-XX
Extended Double Bracket
7 3/4" P
Use with Ripplefold
\$110.34 ea. 2/box

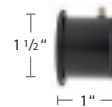

53412-XX
Inside Mount Bracket
\$82.44 ea. 2/box

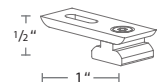

53408-90
Flush Ceiling Bracket
aluminum
\$24.03 ea. 100/box

METAL – Deventer CRS Traversing



59 Black Deventer CRS Rail with Ball End Cap in front and End Cap Finial in back



95 Taupe Deventer CRS Rail with End Cap Finial



29 Satin Nickel Deventer CRS Rail with Notched Finial



24 Satin Brass Deventer CRS Rail with Ball Finial



81 Antique Bronze Deventer CRS Rail with End Cap Finial

1 1/8" Deventer CRS Carriers, Masters and Other Components



52110-25
CRS Carrier
UV-proof, synthetic material
\$0.42 ea.
\$0.35 ea./box of 500



52002-25
-59 Black, -65 Brown + 10%
Slim Line Ball Bearing Carrier
\$0.61 ea.
\$0.51 ea./box of 1000



2107-25 60% fullness, 2 5/8" OC
2106-25 80% fullness, 2 3/8" OC
2105-25 100% fullness, 2 1/8" OC
2108-25 120% fullness, 1 7/8" OC
-59 Black + 10%
Wheeled Connected Snap Carrier
in plastic sleeve
\$1.36 ea.
\$1.14 ea./box of 1000

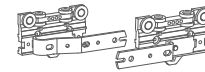

52502-25 Overlap R
52504-25 Underlap L
-59 Black + 10%
Standard Multi-Functional Master
Use stiffener w/ exposed baton
or hooks w/ hidden baton
\$6.55 ea.
\$5.46 ea./box of 100

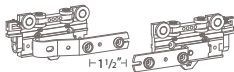

52502-25A Overlap R
52504-25A Underlap L
-59A Black + 10%
Standard Multi-Functional
Master w/ snaps
\$7.94 ea.
\$6.62 ea./box of 100

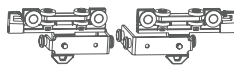

52411-25A Butt R
52412-25A Butt L
Wheeled Butt Master
w/snap adaptor
Designed for hidden baton
\$28.09 ea.
\$23.41 ea./box of 50



52420-25
Metal End Stop w/ Screw
For attaching one
carrier as end stop
\$13.19 ea. 100/box



53413-90
Rail Connector
aluminum, 3"
\$17.68 ea. 25/box



2551-25
Small Extension Arm
\$3.71 ea.
\$3.09 ea./box of 50

Frankfurt Traversing Collection

1" Square Rail Traversing Sets

Recommended weight is 4 lbs./ft. depending on application.



Available Finishes

XX = finish color

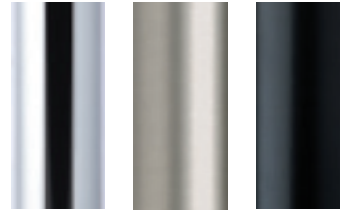

22
Polished
Chrome

29
Satin
Nickel

59
Black

ASSEMBLED PRICING includes rail, end cap finial, carriers, end stop, masters, single brackets and 36" fiberglass baton (see all batons p. 23). Indicate pinch pleat or Ripplefold. Freight is additional.

Square Rail - \$731.07 for the first 4 feet, \$146.01/additional foot.
Double sets are available. Please call sales for a quote, 866-823-3894.

Bracket Count:

Up to 60" = 2 brackets 121-180" = 4 brackets
61-120" = 3 brackets 181-240" = 5 brackets

BREAK PACK PRICING - Components with this designation will have a 20% up charge for broken pack quantities.

Frankfurt Square Rail Components



B8082525-XX
Square Rail, 19.7'
\$47.80/ft.



B1242525-XX
Fina End
Cap Finial
\$42.49 ea.



B11470-25-XX
Wall Bracket
\$174.20 ea.

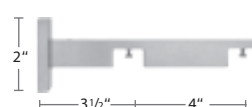

B11472-25-XX
Double Wall Bracket
\$229.94 ea.

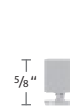

B11473-15-XX
Ceiling Bracket
5/8" Extension
\$83.61 ea.

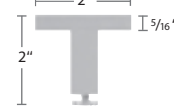

B11473-50-XX
Ceiling Bracket/
Invisible Wall Bracket
\$174.20 ea.



Bracket Extension
B11470-40-XX
\$52.26 ea.



2107-25 60% fullness, 2 5/8" OC
2106-25 80% fullness, 2 3/8" OC
2105-25 100% fullness, 2 1/8" OC
2108-25 120% fullness, 1 7/8" OC
-59 Black + 10%
Wheeled Connected Snap Carrier
in plastic sleeve
\$1.36 ea.
\$1.14 ea./roll of 500



52002-25
Slim Line Ball
Bearing Carrier
\$0.61 ea.
\$0.51 ea./box of 1000



V799-2-00
End Stop
\$0.80 ea.
\$0.66 ea./box of 100

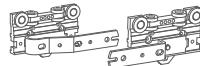

52502-25 Overlap R
52504-25 Underlap L
-59 Black +10%
Standard Multi-Functional Master
Use stiffener w/ exposed baton
or hooks w/ hidden baton
\$6.55 ea.
\$5.46 ea./box of 100



52502-25A Overlap R
52504-25A Underlap L
-59A Black +10%
Standard Multi-Functional
Master w/ snaps
\$7.94 ea.
\$6.62 ea./box of 100



B899-3-00
Rail Connector
\$17.83 ea.

Stuttgart Flat Fascia *NEW!*

1 3/8" Flat Fascia for use with single or double Forest CS Track Systems

Recommended weight is 6 lbs/ft. using Forest CS Track.



Use Flat Fascia with a single or double Forest CS Track System, pages 3-4.

Bracket Count:

Up to 60" = 2 brackets	121-180" = 4 brackets
61-120" = 3 brackets	181-240" = 5 brackets

Available Finishes

XX = finish color

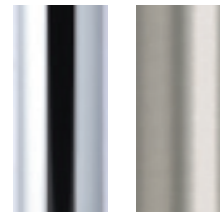

22
Polished
Chrome

29
Satin
Nickel

Flat Fascia Components



B80560070-XX
Flat Fascia Extrusion
\$44.58/ft.

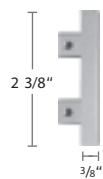

B12460070-XX
Sato End Cap Finial
\$50.91 ea.

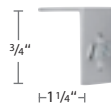

B11588-00
90° Ceiling Bracket
\$26.52 ea.

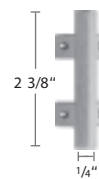

B11530-XX
90° Corner Bracket
\$64.19 ea.

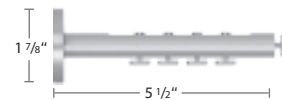

B11373-140-XX
Multi Wall Bracket
\$222.97 ea.

Stuttgart Traversing Collection

Rectangle Rail Traversing Sets

Recommended weight is 4 lbs./ft. depending on application.



Available Finishes

XX = finish color

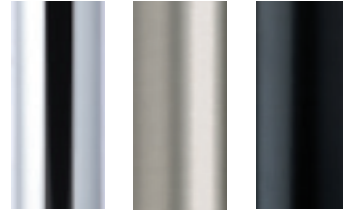

22 Polished Chrome
29 Satin Nickel
59 Black

ASSEMBLED PRICING includes rail, end cap finial, carriers, end stop, masters, single brackets and 36" fiberglass baton (see all batons p. 23). Indicate pinch pleat or Ripplefold. Freight is additional.

Stuttgart Rectangle Rail - \$780.59 for the first 4 feet, \$169.47/additional foot. Double sets are available. Please call sales for a quote, 866-823-3894.

Bracket Count:

Up to 60" = 2 brackets 121-180" = 4 brackets
61-120" = 3 brackets 181-240" = 5 brackets

BREAK PACK PRICING - Components with this designation will have a 20% up charge for broken pack quantities.

Stuttgart Rectangle Rail Components



B8084015-XX
Rectangle Rail, 19.7'
\$38.66/ft.

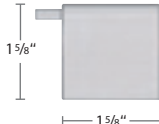

B11580-XX
Square Finial
\$111.41 ea.

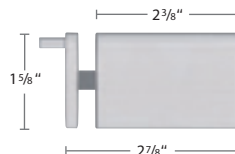

B11581-XX
Square Finial w/ Spacer
\$192.71 ea.

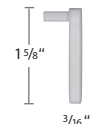

B1254015-XX
End Cap Finial
\$63.23 ea.

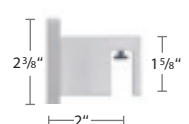

B11570-50-XX
Single Wall Bracket
\$173.20 ea.

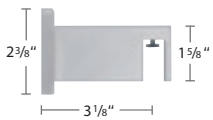

B11570-80-XX
Single Wall Bracket
\$204.75 ea.

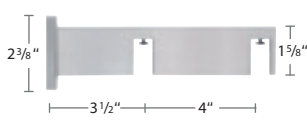

B11570-2-190-XX
Double Wall Bracket
\$245.69 ea.

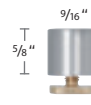

B11873-15-XX
Ceiling Bracket
5/8" Extension
\$51.19 ea.

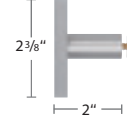

B11573-50-XX
Ceiling Bracket/
Invisible Wall Bracket
\$132.49 ea.



B1224015-XX
Inside Mount Bracket
\$108.40 ea.

Components for both Rectangle Rail and C Rail



Flush Ceiling Bracket
B11592-00 Rectangle Rail
\$21.90 ea.

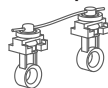

2114-25 60% fullness, 2 5/8" OC
2111-25 80% fullness, 2 3/8" OC
2112-25 100% fullness, 2 1/8" OC
2115-25 120% fullness, 1 7/8" OC
-59 Black +10%
Two-Piece Connected Snap Carrier
w/ Square Base In plastic sleeve, use 4 1/4" snap tape
\$1.10 ea. or \$0.92 ea./roll of 500



52002-25
-59 Black + 10%
Slim Line Ball Bearing Carrier
\$0.61 ea.
\$0.51 ea./box of 1000



V799-2-00
End Stop
\$0.80 ea.
\$0.66 ea./box of 100

Stuttgart Traversing Collection

C-Rail Traversing Sets

Recommended weight is 4 lbs/ft. depending on application.



Available Finishes

XX = finish color

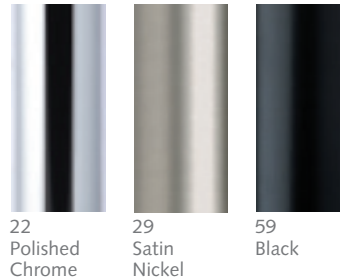

ASSEMBLED PRICING includes rail, end cap finial, carriers, end stop, masters, single brackets and 36" fiberglass baton (see all batons p. 23). Indicate pinch pleat or Ripplefold. Freight is additional.

Stuttgart C Rail - \$859.39 for the first 4 feet, \$110.63/additional foot.

Bracket Count:

Up to 60" = 2 brackets 121-180" = 4 brackets
61-120" = 3 brackets 181-240" = 5 brackets

BREAK PACK PRICING - Components with this designation will have a 20% up charge for broken pack quantities.

Stuttgart C-Rail Components

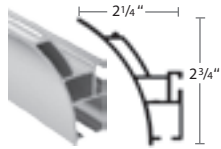

B8087057-XX
C Rail, 19.7'
\$68.46/ft.



B1247057-L-XX
B1247057-R-XX
Sala End Cap Finial
\$90.35 ea.

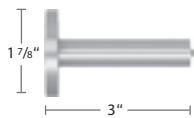

B11873-80-XX
Wall Bracket
\$135.87 ea.

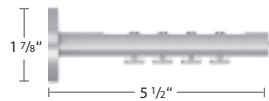

B11373-140-XX
Multi Wall Bracket
\$222.97 ea.



B11591-00
Flush Ceiling Bracket
\$31.57 ea.

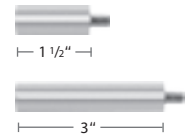

B11870-40-XX
1 1/2"
Bracket Extension
\$52.26 ea.
B11870-80-XX
3" Bracket Extension
\$59.23 ea.

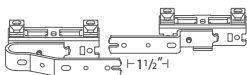

52508-25 Overlap R
52509-25 Underlap L
-59 Black + 10%
Swivel Foot Multi-Functional Master
\$11.55 ea.
\$9.62 ea./box of 100

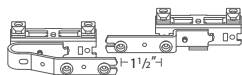

52508-25A Overlap R
52509-25A Underlap L
-59 Black + 10%
Swivel Foot Multi-Functional Master w/ snaps
\$13.69 ea.
\$11.41 ea./box of 100



52410-25 Butt R
52409-25 Butt L
-59 Black + 10%
Standard Butt Master w/ snaps and for baton use
\$15.90 ea.
\$13.25 ea./box of 50



88809-23-00 Overlap R
88809-24-00 Underlap L
-59 Black + 10%
Plastic Snap Master
\$11.50 ea.
\$9.58 ea./box of 25



8899-3-00
Rail Connector
\$17.83 ea.

Stuttgart Collection

1 1/2" and 2 3/4" Oval Rail Traversing Sets

Recommended weight is 4 lbs/ft. depending on application.



Available Finishes

XX = finish color

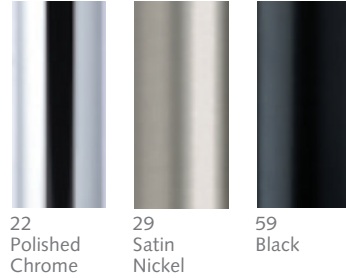

22
Polished
Chrome

29
Satin
Nickel

59
Black

ASSEMBLED PRICING includes rail, end cap finial, carriers, end stop, masters, single brackets and 36" fiberglass baton (see all batons p. 23). Indicate pinch pleat or Ripplefold. Freight is additional.

1 1/2" Oval Rail - \$633.50 for the first 4 feet, \$71.44/additional foot.
2 3/4" Oval Rail - \$732.80 for the first 4 feet, \$87.41/additional foot.
Double sets are available. Please call sales for a quote, 866-823-3894.

Bracket Count:

Up to 60" = 2 brackets 121-180" = 4 brackets
61-120" = 3 brackets 181-240" = 5 brackets

BREAK PACK PRICING - Components with this designation will have a 20% up charge for broken pack quantities.

Stuttgart 1 1/2" and 2 3/4" Oval Rail Components



B8084020-XX
1 1/2" Oval Rail, 19.7'
\$35.57/ft.

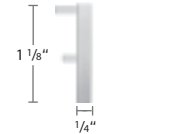

B1254022-XX
1 1/2" Sona End Cap
\$67.37 ea.

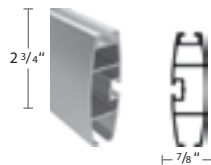

B8087022-XX
2 3/4" Oval Rail, 19.7'
\$51.01/ft.

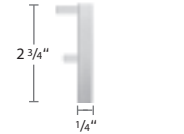

B1247022-XX
2 3/4" Sona End Cap
\$81.87 ea.

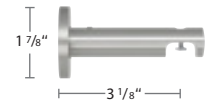

B11370-80-XX
Single Wall Bracket
\$92.93 ea.



B11592-00
Flush Ceiling Bracket
\$21.90 ea.

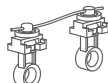

2114-25 60% fullness, 2 5/8" OC
2111-25 80% fullness, 2 3/8" OC
2112-25 100% fullness, 2 1/8" OC
2115-25 120% fullness, 1 7/8" OC
-59 Black +10%
Two-Piece Connected Snap Carrier
w/ Square Base In plastic sleeve, use 4 1/4" snap tape
\$1.10 ea. or \$0.92 ea./roll of 500



52002-25
Slim Line Ball Bearing Carrier
\$0.61 ea.
\$0.51 ea./box of 1000



V799-2-00
End Stop
\$0.80 ea.
\$0.66 ea./box of 100

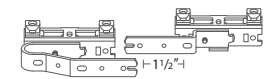

52508-25 Overlap R
52509-25 Underlap L
-59 Black + 10%
Swivel Foot Multi-Functional
Master
\$11.55 ea.
\$9.62 ea./box of 100



1 1/2" Oval Rail in 22 Polished Chrome with Sona End Cap



2 3/4" Oval Rail in 22 Polished Chrome with Sona End Cap

Pictured here is a 2 3/4" Stuttgart Oval Rail Traversing Set in finish 29 Satin Nickel with a Ripplefold sheer.

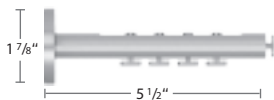

B11373-140-XX
Multi Wall Bracket
\$222.97

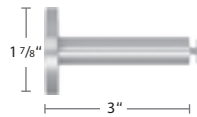

B11873-80-XX
Extended Wall/Ceiling Bracket
\$135.87 ea.

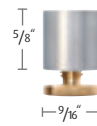

B11873-15-XX
Ceiling Bracket
5/8" Extension
\$51.19 ea.

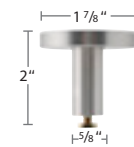

B11873-50-XX
Ceiling Bracket/
Invisible Wall Bracket
\$96.35 ea.



52508-25A Overlap R
52509-25A Underlap L
-59 Black + 10%
Swivel Foot Multi-Functional
Master w/ snaps
\$13.69 ea. 📦
\$11.41 ea./box of 100



52410-25 Butt R
52409-25 Butt L
-59 Black + 10%
Standard Butt Master
w/ snaps and for baton use
\$15.90 ea. 📦
\$13.25 ea./box of 50



B8809-23-00 Overlap R
B8809-24-00 Underlap L
-59 Black + 10%
Plastic Snap Master
\$11.50 ea. 📦
\$9.58 ea./box of 25

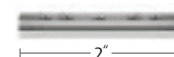

B899-3-00
Rail Connector
\$17.83 ea.

Strong and beautiful **DECORATIVE WOOD COLLECTIONS**

Forest offers four collections of solid wood drapery hardware for you to choose from. Our newest pole set collection, Valencia, is made of Ash wood with beautiful, bold grain and has a diameter of 1 3/4". Seville is a collection of poles in 1 3/8" diameter. The Cordoba collection with a 2" diameter is available in pole sets, traversing or as a motorized hardware solution. At 2 3/4", Granada is our largest diameter wood drapery hardware collection. Like Cordoba, Granada can be used as a pole set, traversing or a motorized treatment. For motorization options, see pages 91-92.

Valencia 1 3/4"

Pole Sets



Seville 1 3/8"

Pole Sets





Cordoba 2"

Pole Sets, Traversing & Motorized



Granada 2 3/4"

Pole Sets, Traversing & Motorized



Valencia Collection

1 3/4" Wood Pole Sets

Recommended weight is 4 lbs./ft. depending on application.



Ash wood from France gives this collection a beautifully grained appearance.



1045SWO-XX
1 3/4" Smooth Wood Pole
Stock Length: 8'
\$33.93/ft.

1 3/4" Valencia Finials

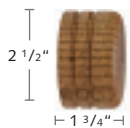

1145WEN-XX
End Cap Finial
\$10.12 ea.



1145SMO-XX
Smooth Ball Finial
\$22.00 ea.



1145RIN-XX
Ringed Ball Finial
\$22.00 ea.



1145GRA-XX
Granada Finial
\$17.33 ea.

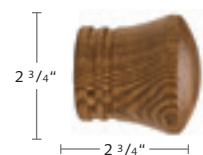

1145CAS-XX
Castell Finial
\$18.23 ea.

1 3/4" VALENCIA POLES 1 3/8" SEVILLE POLES 2" CORDOBA POLES 2 3/4" GRANADA POLES TRAVERSING

83 Tiger Oak Smooth Pole wth Smooth Ball Finial



84 Espresso Smooth Pole with End Cap Finial



80 Driftwood Smooth Pole with Castell Finial



81 Weathered Oak Smooth Pole with Granada Finial



82 Redwood Smooth Pole with Ringed Ball Finial



Available Finishes XX = finish color



80
Driftwood



81
Weathered Oak



82
Redwood



83
Tiger Oak



84
Espresso

1 3/4" Valencia Bracket & Ring

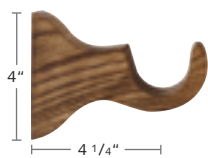

1245WBR-XX
Valencia Wall Bracket
\$36.16 ea.

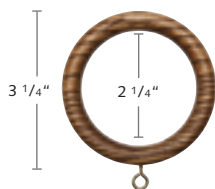

1345WRI-XX
Valencia Wood Ring
\$2.53 ea.

WOOD – 1 3/4" Valencia

Seville Collection

1 3/8" Wood Pole Sets

Recommended weight is 4 lbs/ft. depending on application.



1035SWO-XX
1 3/8" Smooth Wood Pole
Stock Length: 13'
\$7.09/ft.

1 3/8" Seville Finials

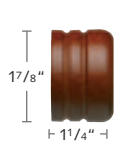

1135WEN-XX
End Cap Finial
\$6.36 ea.

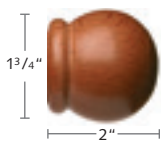

1135BOL-XX
Bola Finial
\$8.96 ea.

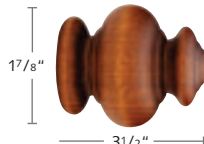

1135ODI-XX
Odiseia Finial
\$22.11 ea.

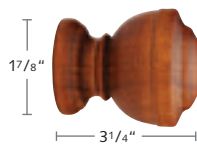

1135CAL-XX
Calice Finial
\$23.96 ea.

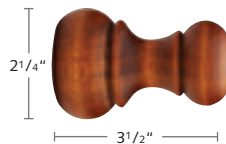

1135CAM-XX
Campina Finial
\$20.74 ea.

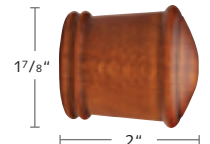

1135COR-XX
Corona Finial
\$11.25 ea.

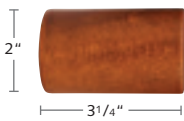

1135COU-XX
Country Finial
\$23.68 ea.

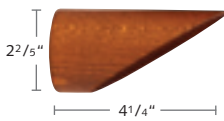

1135DEK-XX
Deka Finial
\$18.87 ea.

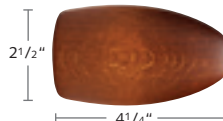

1135BAS-XX
Basic Finial
\$18.87 ea.

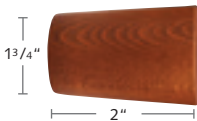

1135ZEN-XX
Zenith Finial
\$21.88 ea.



1135RED-XX
Redondo Finial
\$47.34 ea.

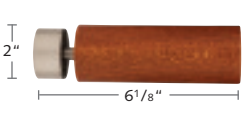

1135MOS-XX
Mossa Finial
\$49.31 ea.

WOOD - 1 3/8" Seville

1 3/4" VALENCIA POLES **1 3/8" SEVILLE POLES** 2" CORDOBA POLES 2 3/4" GRANADA POLES TRAVERSING



Available Finishes XX = finish color

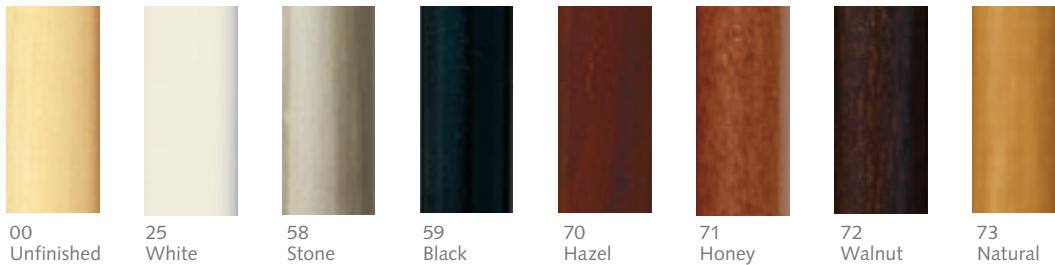

00 Unfinished 25 White 58 Stone 59 Black 70 Hazel 71 Honey 72 Walnut 73 Natural

1 3/8" Seville Brackets, Ring, Holdback and Batons



1235CYL-XX
Cylinder Bracket
\$13.30 ea.



1235CLA-XX
Classic Open Bracket
\$15.81 ea.

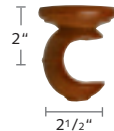

1235CEI-XX
Ceiling Bracket
\$13.34 ea.

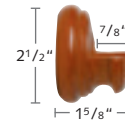

1235IMB-XX
Inside Mount Bracket
\$10.07 ea.

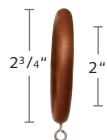

1335WRI-XX
1 3/8" Wood Ring w/ Eyelet
\$2.19 ea.

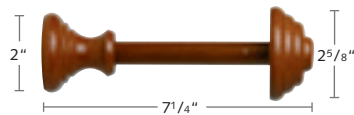

16WHOLD-XX
Wood Holdback
\$17.41 ea.



19WWAND-XX
40" Wood Baton
\$17.76 ea. unfinished
\$21.87 ea. finished

See all batons p. 23



19CWAND-XX
40" Modern Wood Baton
\$17.76 ea. unfinished
\$21.87 ea. finished

See all batons p. 23

Cordoba Collection

2" Wood Pole Sets

Recommended weight is 4 lbs/ft. depending on application.



1051SWO-XX
2" Smooth
Stock Length: 14'
\$15.89/ft. unfinished
\$18.02/ft. finished
\$26.99/ft. antiqued



1051RWO-XX
2" Reeded
Stock Length: 14'
Not available in finishes 37, 45 or 58
\$17.64/ft. unfinished
\$22.97/ft. finished



1051RSW-XX
2" Routed Smooth
Stock Length: 14'
\$17.64/ft. unfinished
\$22.97/ft. finished
\$29.86/ft. antiqued



1051RRW-XX
2" Routed Reeded
Stock Length: 14'
Not available in finishes 37, 45 or 58
\$21.09/ft. unfinished
\$25.10/ft. finished



MOTORIZED
PAGE 91

2" Cordoba Finials

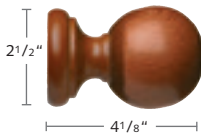

1151SMO-XX
Smooth Ball Finial
\$26.56 ea. unfinished
\$34.94 ea. finished

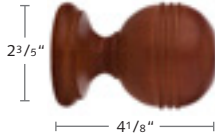

1151RIN-XX
Ringed Ball Finial
\$27.64 ea. unfinished
\$35.15 ea. finished
\$50.13 ea. antiqued

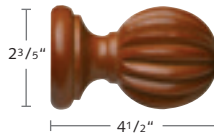

1151FLU-XX
Fluted Ball Finial
\$39.84 ea. unfinished
\$49.06 ea. finished



1151CUP-XX
Cup Finial
\$24.41 ea. unfinished
\$29.70 ea. finished

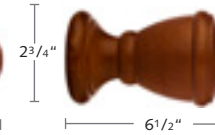

1151TRA-XX
Traditional Finial
\$24.41 ea. unfinished
\$29.70 ea. finished
\$44.48 ea. antiqued

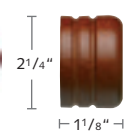

1151WEN-XX
End Cap Finial
\$10.41 ea. unfinished
\$13.00 ea. finished
\$17.17 ea. antiqued



1151TUD-XX
Tudor Finial
\$45.59 ea. unfinished
\$50.44 ea. finished



1151WIN-XX
Windsor Finial
\$42.53 ea. unfinished
\$52.61 ea. finished
\$74.33 ea. antiqued

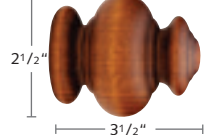

1151ODI-XX
Odiseia Finial
\$28.17 ea. unfinished
\$41.82 ea. finished

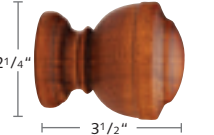

1151CAL-XX
Calice Finial
\$29.30 ea. unfinished
\$42.89 ea. finished

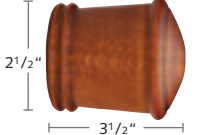

1151COR-XX
Corona Finial
\$27.43 ea. unfinished
\$40.81 ea. finished

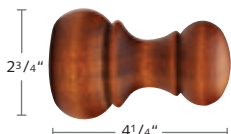

1151CAM-XX
Campina Finial
\$37.26 ea. unfinished
\$55.41 ea. finished



1151COU-XX
Country Finial
\$32.25 ea. unfinished
\$48.25 ea. finished



1151DEK-XX
Dekka Finial
\$33.92 ea. unfinished
\$50.38 ea. finished

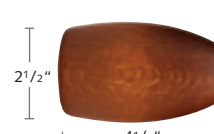

1151BAS-XX
Basic Finial
\$33.92 ea. unfinished
\$50.38 ea. finished



1151ZEN-XX
Zenith Finial
\$33.12 ea. unfinished
\$49.17 ea. finished

WOOD - 2" Cordoba

1 3/4" VALENCIA POLES 1 3/8" SEVILLE POLES **2" CORDOBA POLES** 2 3/4" GRANADA POLES TRAVERSING

71 Honey Smooth Pole with Zenith Finial



58 Stone Smooth Pole with Ringed Ball Finial

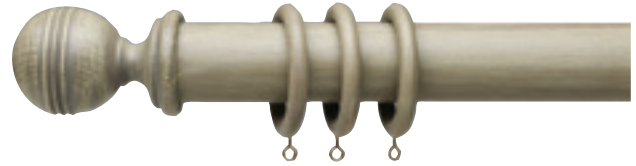

72 Walnut Reeded Pole with Odiseia Finial

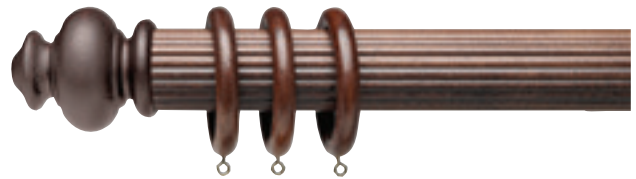

Available Finishes XX = finish color / *Not all components are stocked in Antiqued finishes. Please call for availability.

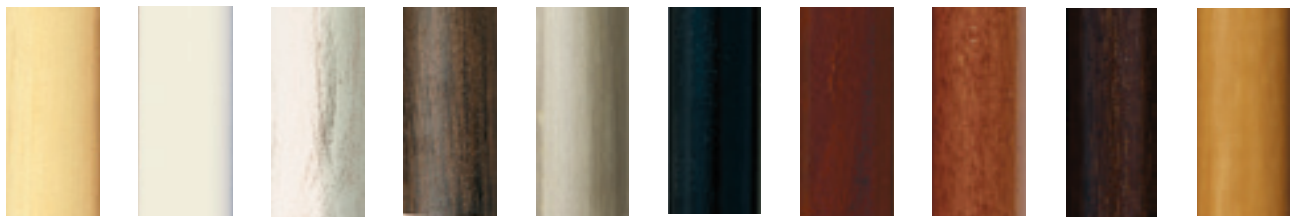

00 Unfinished	25 White	37 Sand Gold Antiqued* Smooth Poles Only	45 Leather Antiqued* Smooth Poles Only	58 Stone Smooth Poles Only	59 Black	70 Hazel	71 Honey	72 Walnut	73 Natural
------------------	-------------	--	--	-------------------------------------	-------------	-------------	-------------	--------------	---------------

2" Cordoba Brackets, Rings, Rosette and Batons

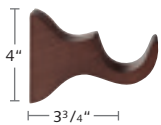

1251WBR-XX
Wood Bracket
\$29.28 ea. unfinished
\$36.16 ea. finished
\$52.93 ea. antiqued



1253WBR-XX
Extended Bracket
\$53.07 ea. unfinished
\$65.55 ea. finished



1251EUR-XX
Euro Wood Bracket
\$18.71 ea. unfinished
\$24.42 ea. finished
\$37.55 ea. antiqued

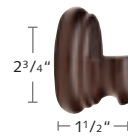

1251WIM-XX
Open Inside Mount
Bracket
\$22.39 ea. unfinished
\$27.63 ea. finished
\$39.94 ea. antiqued



1351WRI-XX
2" Wood Ring w/ Eyelet
\$3.79 ea. unfinished
\$5.10 ea. finished
\$8.37 ea. antiqued



14WLSHI-00
Rosette w/ Carved Post
\$22.18 ea. unfinished

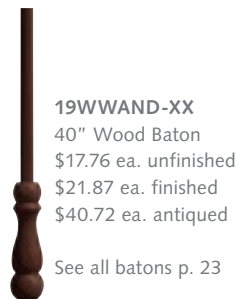

19WWAND-XX
40" Wood Baton
\$17.76 ea. unfinished
\$21.87 ea. finished
\$40.72 ea. antiqued

See all batons p. 23

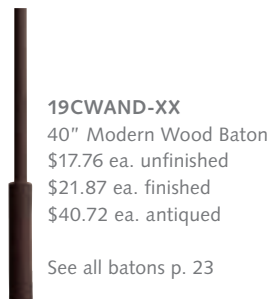

19CWAND-XX
40" Modern Wood Baton
\$17.76 ea. unfinished
\$21.87 ea. finished
\$40.72 ea. antiqued

See all batons p. 23

Granada Collection

2 3/4" Wood Pole Sets

Recommended weight is 4 lbs/ft. depending on application.



1072SWO-00
2 3/4" Smooth
Stock Length: 13'
\$29.98/ft.



1072RWO-00
2 3/4" Reeded
Stock Length: 13'
\$31.55/ft.



1072RSW-00
2 3/4" Routed Smooth
Stock Length: 13'
\$31.55/ft.



1072RRW-00
2 3/4" Routed Reeded
Stock Length: 13'
\$33.30/ft.



MOTORIZED
PAGE 91

2 3/4" Granada Finials



1172WEN-XX
End Cap Finial
\$12.77 ea.

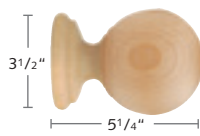

1172SMO-XX
Smooth Ball Finial
\$42.16 ea.

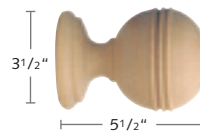

1172RIN-XX
Ringed Ball Finial
\$43.89 ea.

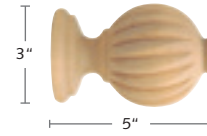

1172FLU-XX
Fluted Ball Finial
\$57.18 ea.

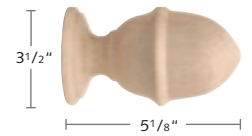

1172CUP-XX
Cup Finial
\$36.66 ea.

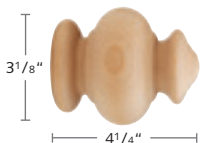

1172ODI-XX
Odiseia Finial
\$41.96 ea.

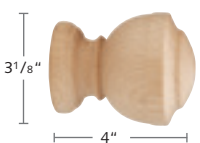

1172CAL-XX
Calice Finial
\$43.10 ea.



1172CAM-XX
Campina Finial
\$55.67 ea.

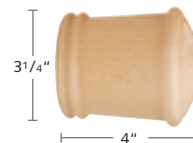

1172COR-XX
Corona Finial
\$40.95 ea.

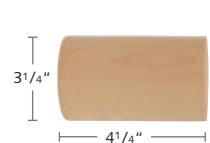

1172COU-XX
Country Finial
\$48.18 ea.

Available Finishes: 2 3/4" Granada Collection is stocked unfinished

Call sales to request a finish and pricing.



00
Unfinished

2 3/4" Granada Brackets / Ring / Rosette / Baton

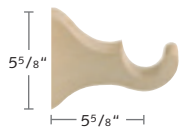

1272WBR-00
Wood Bracket
\$31.72 ea.



1272EUR-00
Euro Wood Bracket
\$37.79 ea.



1272WIM-00
Open Inside Mount Bracket
\$35.71 ea.

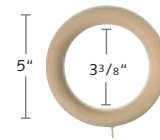

1372WRI-00
Wood Ring w/ Eyelet
\$14.91 ea.

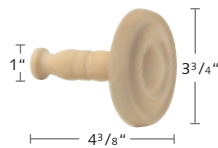

14WLSHI-00
Wood Rosette
w/ Carved Post
\$22.18 ea.



19WWAND-00
Wood Baton
Length: 40"
\$17.76 ea. unfinished
\$21.87 ea. finished
See all batons p. 23

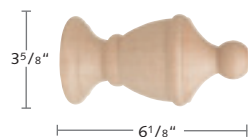

1172TRA-XX
Traditional Finial
\$58.61 ea.



1172TUD-XX
Tudor Finial
\$54.10 ea.



1172WIN-XX
Windsor Finial
\$78.10 ea.



1172ACO-XX
Acorn Finial
\$50.49 ea.

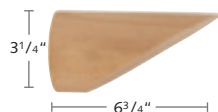

1172DEK-XX
Deka Finial
\$50.65 ea.



1172BAS-XX
Basic Finial
\$50.65 ea.



1172ZEN-XX
Zenith Finial
\$49.51 ea.

Traversing 2" Cordoba and 2 3/4" Granada

Hand, Baton or Cord Draw – Single or Double Treatment – With or Without C-Rings



ASSEMBLED PRICING includes wood pole fascia, assembled track, brackets, customer's choice of finials, c-ring where specified, and 36" fiberglass baton. Freight is additional.



MOTORIZED
PAGE 91

	Traversing first 4 feet	Traversing ea. add'l ft.	C-Ring first 4 feet	C-Ring ea. add'l ft.
2" Cordoba Single Unfinished	\$351.00	\$28.32	\$510.62	\$50.27
2" Cordoba Single Finished	\$415.03	\$34.65	\$619.74	\$63.43
2" Cordoba Double Unfinished	\$394.87	\$38.33	\$668.84	\$60.25
2" Cordoba Double Finished	\$449.44	\$44.64	\$780.09	\$73.42
2 3/4" Granada Single Unfinished	\$403.66	\$35.34	\$587.20	\$107.69
2 3/4" Granada Single Finished	\$477.30	\$47.00	\$712.70	\$116.14
2 3/4" Granada Double Unfinished	\$454.10	\$44.95	\$771.71	\$117.67
2 3/4" Granada Double Finished	\$528.99	\$57.92	\$897.11	\$129.43

2" Cordoba Available Finishes XX = finish color / *Not all components are stocked in Antiqued finishes. Please call for availability.



2 3/4" Granada Stocked Unfinished Only Call sales to request a finish color and for pricing.

00
Unfinished

Traversing 2" Cordoba and 2 3/4" Granada Finials

Additional finials can be found on page 57 (2" Cordoba) and page 59-60 (2 3/4" Granada).



Traversing 2" Cordoba and 2 3/4" Granada Pole Options



1051RSW-XX
2" CORDOBA Smooth
Stock Length: 14'

1072RSW-00
2 3/4" GRANADA Smooth
Stock Length: 13'



1051RRW-XX
2" CORDOBA Reeded
Stock Length: 14'

1072RRW-00
2 3/4" GRANADA Reeded
Stock Length: 13'

Traversing 2" Cordoba and 2 3/4" Granada Traversing Track Options

Use hand draw CS® Track in white, brown, black or silver with color coordinating components, or use cord draw CCS® Track in white, brown or silver with color coordinating components. Use pinch pleat or Ripplefold carriers with overlap or butt masters. To review all carrier and master options, go to pages 3-4 for CS and 9-10 for CCS.

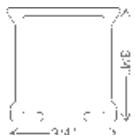
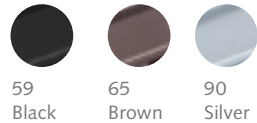

CS® - Contract System

The Hotel Track - Hand draw track system designed for hotels or any other heavy-duty use. Aluminum extrusion, powder coated and lubricated for wall mount. Available in -25 white, -59 black, -65 brown and -90 silver.



CCS® - Contract Cord System

Aluminum extrusion, white, powder coated, lubricated, wall mount, with separate channels for use with cord. Available in -25 white, -65 brown and -90 silver.

Traversing 2" Cordoba and 2 3/4" Granada Brackets & Wood Batons (order separately)



3280-25
-59 Black , -65 Brown,
-90 Silver
3" Wall Bracket
heavy duty
for wood poles
projection 2 1/2"

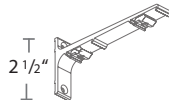

3281-25
-59 Black , -65 Brown
6" Double Wall Bracket
heavy duty
for wood poles
projection 1 1/2", 5 1/2"



3284-25
-65 Brown
10" Triple Wall Bracket
heavy duty
for wood poles
projection 2", 6 5/8", 9 5/16"



19WWAND-XX
40" Wood Baton
\$17.76 ea. unfinished
\$21.87 ea. finished
\$40.72 ea. antiqued

See all batons p. 23



19CWAND-XX
40" Modern Wood Baton
\$17.76 ea. unfinished
\$21.87 ea. finished
\$40.72 ea. antiqued

See all batons p. 23

Traversing 2" Cordoba and 2 3/4" Granada Optional C-Rings & Components

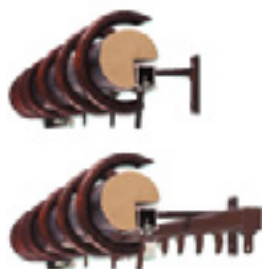

1352WRI-XX
C-Ring
with white, black
or brown carrier



52007-25
-59 Black , -65 Brown
C-Ring Carrier



52405-90 Overlap R
52406-90 Underlap L
-65 Brown
C-Ring Master Carrier

Fashion and functionality in window coverings . . . **FOREST ROLLER SHADES**

Forest Roller Shades are high quality for residential or commercial use. Apollo Basic Roller Shades are chain drawn and available in white, black or bronze. Forest Mercury Decorative Roller Shades are available in a variety of designer finishes. All roller shades can be fabricated with one of our in stock fabrics or choose from more than a hundred options in our Eclipse fabric book.

Apollo Basic Roller Shades

Direct, Double and Cassette Roller Shades



Climate Screen

Insulating Shades

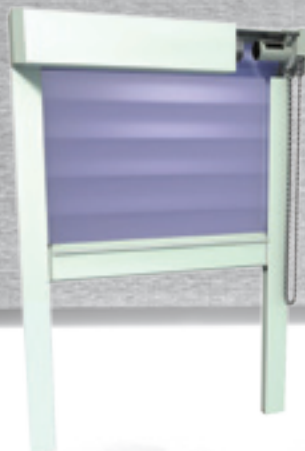

Mercury Decorative Roller Shades

Large Fascia, Direct, Basic, Semi Open, Square and Ultimate Mount Roller Shades



ROLLER SHADES



CHILD SAFETY
PAGE 100



APOLLO - Single Direct Mount

Forest Apollo - Single Direct Mount roller shades can be wall or ceiling mounted in a commercial or residential setting. Apollo uses a bidirectional clutch with a tube diameter of 1 1/2" (38 mm). The maximum weight is 8 lbs, 13 oz (4 kg).

ASSEMBLED PRICING includes one of our six stock fabrics, 1 1/2" / 38 mm tube, roller mechanism, direct mount brackets, bracket cover, bottom rail with end cap and child safety device. Side channels are additional. Freight is additional.

		WIDTH							
		24"	36"	48"	60"	72"	84"	96"	108"
LENGTH	24"	\$179.89	\$205.65	\$231.42	\$257.19	\$282.95	\$308.72	\$334.49	\$401.38
	36"	\$190.82	\$216.58	\$242.35	\$268.12	\$293.88	\$319.66	\$345.43	\$414.51
	48"	\$201.71	\$227.47	\$253.23	\$279.00	\$304.76	\$330.54	\$356.31	\$427.57
	60"	\$212.63	\$238.39	\$264.16	\$289.93	\$315.69	\$341.47	\$367.23	
	72"	\$223.51	\$249.28	\$275.05	\$300.81	\$326.58	\$352.35	\$378.13	
	84"	\$234.43	\$260.20	\$285.98	\$311.75	\$337.51			
	96"	\$245.32	\$271.08	\$296.86	\$322.62				
108"	\$256.25	\$282.02	\$307.79						



APOLLO - Double Direct Mount

Forest Apollo - Double Direct Mount roller shades can be wall or ceiling mounted in a commercial or residential setting. Apollo uses a bidirectional clutch with a tube diameter of 1 1/2" (38 mm). The maximum weight is 8 lbs, 13 oz (4 kg).

ASSEMBLED PRICING includes one of our six stock fabrics, 1 1/2" / 38 mm tube, roller mechanism, direct mount brackets, bracket cover, bottom rail with end cap and child safety device. Side channels are additional. Freight is additional.

		WIDTH							
		24"	36"	48"	60"	72"	84"	96"	108"
LENGTH	24"	\$359.77	\$411.31	\$462.84	\$514.37	\$565.91	\$617.44	\$668.98	\$802.77
	36"	\$381.63	\$433.17	\$484.70	\$536.24	\$587.77	\$639.32	\$690.86	\$829.02
	48"	\$403.41	\$454.94	\$506.46	\$557.99	\$609.53	\$661.08	\$712.61	\$855.14
	60"	\$425.25	\$476.78	\$528.32	\$579.85	\$631.39	\$682.94	\$734.45	
	72"	\$447.03	\$498.56	\$550.10	\$601.63	\$653.16	\$704.70	\$756.25	
	84"	\$468.87	\$520.40	\$571.96	\$623.49	\$675.02			
	96"	\$490.64	\$542.16	\$593.71	\$645.25				
108"	\$512.51	\$564.04	\$615.57						

Apollo Roller Shade Finish



25 White

Apollo Roller Shade Components – for Direct Mount



71119-90
1 1/2" / 38mm
19' Tube, aluminum
\$4.35/ft.



72309HD-25
Heavy Duty Clutch
w/ end plug
\$11.27/set, 1 set/box



72306-25
Multi-Purpose Bracket
steel, 2 pcs
\$3.95/set, 1 set/box



72304-25
Bracket Cover
\$1.92/set, 1 set/box



72305-25
Double Bracket
steel, 2 pcs
\$23.70/set, 1 set/box



810119-25
One Piece Inside Mount
Side Guide Profile, 19'
\$12.16/ft.

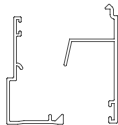

2 Piece Outside Mount
Side Channel
71619-25 Bottom
\$5.88/ft.
71719-25 Top
\$5.05/ft.



49018-25
Bead Chain, white
with spacers
\$0.54/yd.



Endless Chain
Nickel
49020-90, 29" \$2.21 ea.
49024-90, 69" \$3.71 ea.



79004-25
Chain Safety Device
includes 8' chain
\$4.58 ea. 1/box



79003-25
Chain Safety Device
\$2.25 ea. 1/box



42801-25
Chain Connector,
plastic
\$0.19 ea.



79002-25
Brush
for Bottom Rail
\$0.64/yd.



810219-25
Bottom Profile
\$4.27/ft.

Apollo Roller Shades - In Stock Fabric Options



74002-99
3% Solar Fabric
Off White
width = 118 in.
length = 27 yds.



74003-55
3% Solar Fabric
Light Grey
width = 98 in.
length = 32 yds.

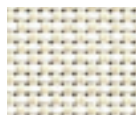

74004-97
3% Solar Fabric
Oyster
width = 98 in.
length = 30 yds.

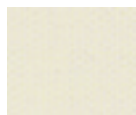

74001-98
Blackout Fabric
Ivory
width = 100 in.
length = 32 yds.

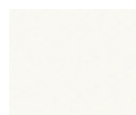

74005-01
Blackout Fabric
Frost
width = 118 in.
length = 30 yds.



74006-08
Blackout Fabric
Ash
width = 118 in.
length = 30 yds.



Hundreds of fabric options are available in our Eclipse fabric collection. Call sales for a quote.



CHILD SAFETY
PAGE 100

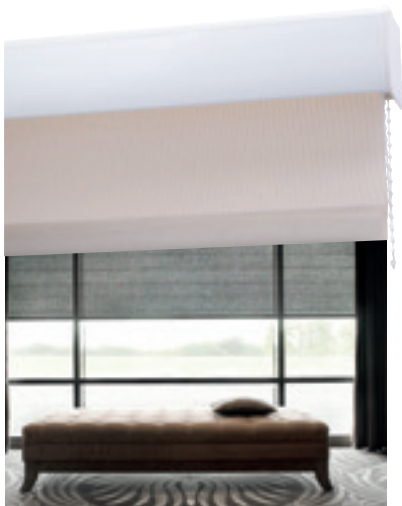

APOLLO - Cassette Mount

Forest Apollo - Cassette Mount roller shades are recommended for commercial or residential settings. Apollo uses a bidirectional clutch with a tube diameter of 1 1/2" (38 mm). The maximum weight is 8 lbs, 13 oz (4 kg).

ASSEMBLED PRICING includes one of our six stock fabrics, 1 1/2" / 38 mm tube, roller mechanism, direct mount brackets, bracket cover, bottom rail with end cap and child safety device. Side channels are additional. Freight is additional.

		WIDTH							
		24"	36"	48"	60"	72"	84"	96"	108"
LENGTH	24"	\$239.96	\$269.00	\$306.65	\$344.30	\$381.95	\$419.60	\$457.25	\$522.57
	36"	\$254.71	\$283.76	\$321.42	\$359.06	\$396.71	\$434.36	\$472.02	\$539.45
	48"	\$269.51	\$298.56	\$336.21	\$373.86	\$411.51	\$449.16	\$486.81	\$556.35
	60"	\$284.27	\$313.31	\$350.97	\$388.62	\$426.27	\$463.92	\$501.57	
	72"	\$299.06	\$328.10	\$365.76	\$403.41	\$441.05	\$478.71	\$516.37	
	84"	\$313.82	\$342.87	\$380.52	\$418.18	\$455.83			
	96"	\$328.62	\$357.66	\$395.31	\$432.97				
	108"	\$343.38	\$372.42	\$410.08					

Apollo Roller Shades - In Stock Fabric Options



74002-99
3% Solar Fabric
Off White
width = 118 in.
length = 27 yds.



74003-55
3% Solar Fabric
Light Grey
width = 98 in.
length = 32 yds.



74004-97
3% Solar Fabric
Oyster
width = 98 in.
length = 30 yds.

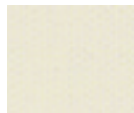

74001-98
Blackout Fabric
Ivory
width = 100 in.
length = 32 yds.

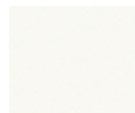

74005-01
Blackout Fabric
Frost
width = 118 in.
length = 30 yds.

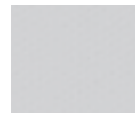

74006-08
Blackout Fabric
Ash
width = 118 in.
length = 30 yds.



Hundreds of fabric options are available in our Eclipse fabric collection. Call sales for a quote.

ROLLER SHADES - Apollo Cassette

Apollo Roller Shade Finish



25 White

Apollo Roller Shade Components – for Cassette Mount



71119-90
1 1/2" / 38 mm
19' Tube, aluminum
\$4.35/ft.



72309HD-25
Heavy Duty Clutch
w/ end plug
\$11.27/set, 1 set/box



72307-90
Wall Bracket
steel
\$9.25 ea.



72308-90
Ceiling Bracket
steel
\$3.62 ea.



71312-25
Cassette Headrail, 11'9"
\$5.87/ft.



72306-25
Multi-Purpose Bracket
steel, 2 pcs
\$3.95/set, 1 set/box



72314-25
Cassette Bracket Covers
plastic
\$7.88/set, 1 set/box



71412-25
Cassette Valance, 11'9"
aluminum, white
\$3.38/ft.



810119-25
One Piece Inside Mount
Side Guide Profile, 19'
\$12.16/ft.

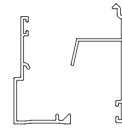

2 Piece Outside Mount
Side Channel
71619-25 Bottom
\$5.88/ft.
71719-25 Top
\$5.05/ft.



49018-25
Bead Chain, white
with spacers
\$0.54/yd.



Endless Chain
Nickel
49020-90, 29" \$2.21 ea.
49024-90, 69" \$3.71 ea.



79004-25
Chain Safety Device
includes 8' chain
\$4.58 ea. 1/box



79003-25
Chain Safety Device
\$2.25 ea. 1/box



42801-25
Chain Connector,
plastic
\$0.19 ea.



79002-25
Brush
for Bottom Rail
\$0.64/yd.



810219-25
Bottom Profile
\$4.27/ft.

ROLLER SHADES – Mercury Decorative

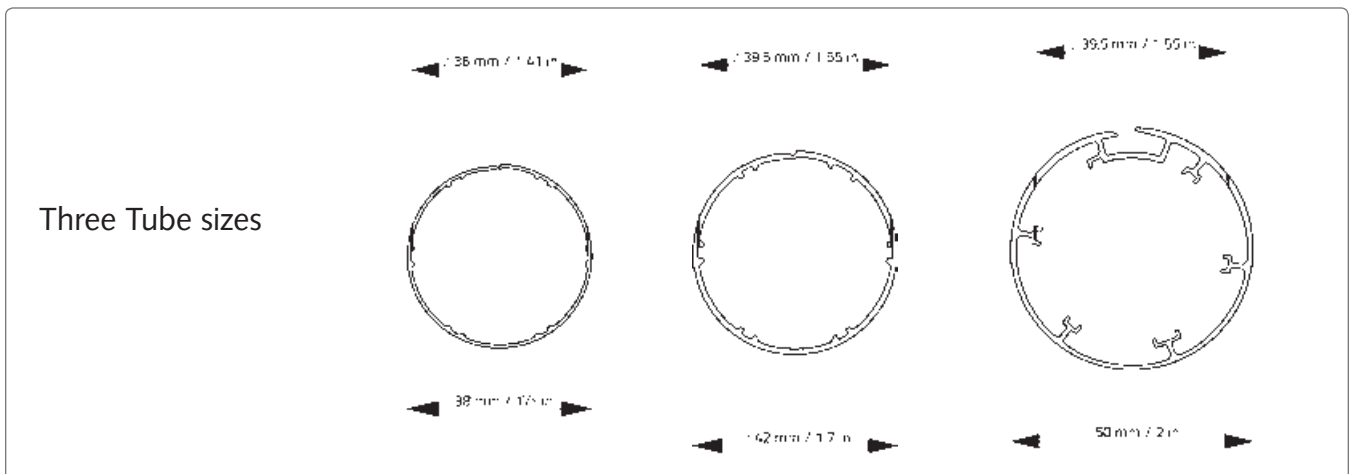
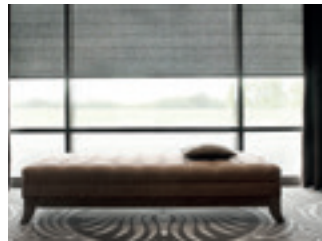



CHILD SAFETY
PAGE 100



MOTORIZED
PAGE 93

MERCURY Decorative Roller Shades

Forest Mercury Decorative Roller Shades are recommended for commercial or residential settings. Mercury Roller Shades use a bidirectional clutch with a tube diameters of 38mm, 42mm and 50mm. See pages 91-92 for information on Motorized Mercury Roller Shades.



LARGE FASCIA DOUBLE

Two shades behind one large fascia



DIRECT MOUNT

Easy, simple installation



BASIC MOUNT

Easy, simple installation



SEMI OPEN MOUNT

Luxury installation cassette



SQUARE MOUNT

Cassette is completely closed



ULTIMATE MOUNT

Designer look and finishes.

Mercury Roller Shades - In Stock Fabric Options



74002-99
3% Solar Fabric
Off White
width = 118 in.
length = 27 yds.



74003-55
3% Solar Fabric
Light Grey
width = 98 in.
length = 32 yds.



74004-97
3% Solar Fabric
Oyster
width = 98 in.
length = 30 yds.

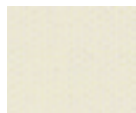

74001-98
Blackout Fabric
Ivory
width = 100 in.
length = 32 yds.

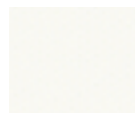

74005-01
Blackout Fabric
Frost
width = 118 in.
length = 30 yds.



74006-08
Blackout Fabric
Ash
width = 118 in.
length = 30 yds.



Hundreds of fabric options are available in our Eclipse fabric collection. Call sales for a quote.



MERCURY Decorative Roller Shades

ASSEMBLED PRICING includes one of our six stock fabrics, choice of 38mm tube, roller mechanism, brackets, bracket covers, and counterweight or bottom rail with end cap. Side channels are additional. Add 10% for 42mm and 15% for 50mm. Freight is additional.



CHILD SAFETY
PAGE 100



Mercury – Large Fascia Double

- Ideal for double treatment
- Complete blackout
- Heavy duty and quick, easy installation



MOTORIZED
PAGE 93

ASSEMBLED PRICING:

	WIDTH							
	24"	36"	48"	60"	72"	84"	96"	108"
24"	405.81	497.48	589.15	681.86	773.53	865.20	956.87	1048.54
36"	457.29	522.35	606.82	715.95	789.00	882.50	976.01	1069.51
48"	508.77	548.96	618.61	722.77	895.57	899.81	995.14	1090.48
60"	560.25	600.44	640.63	729.59	812.21	917.11	1014.28	
72"	611.73	651.92	692.11	733.34	823.04	934.42		
84"	663.21	703.40	743.59	784.82	825.01			
96"	714.69	754.88	795.07	836.30				
108"	766.17	806.36	846.55					

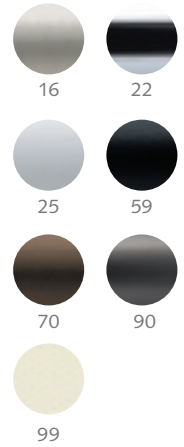

Mercury – Direct Mount

- End caps in designer colors
- Contemporary, clean look
- Easy Installation



MOTORIZED
PAGE 93

ASSEMBLED PRICING:

	WIDTH							
	24"	36"	48"	60"	72"	84"	96"	108"
24"	189.52	233.82	278.12	322.93	367.22	411.52	455.82	500.11
36"	215.26	245.51	292.02	339.07	374.57	419.75	464.93	510.12
48"	241.01	259.56	294.80	342.30	381.91	427.98	474.05	520.12
60"	266.75	285.30	303.86	345.53	385.58	436.21	483.17	
72"	292.49	311.05	329.60	348.67	390.73	444.44		
84"	318.24	336.79	355.35	374.41	392.97			
96"	343.98	362.54	381.09	400.16				
108"	369.72	388.28	406.83					

Mercury – Large Fascia Double Components

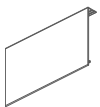

77010-25
Fascia Front, 19'
White
\$16.87/ft.

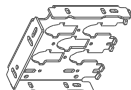

76050-25
Fascia Box Bracket
\$25.33 ea.



76051-90
Box Bracket
Attachment Adaptor
\$4.68/set

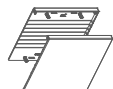

76052-25
Box Bracket
End Caps
\$9.03/set



76053-25
Chain Guide Adaptor
Long
\$2.36 ea.



76054-25
Chain Guide Adaptor
Medium
\$4.38 ea.

Mercury – Direct Mount Components

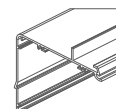

77004-25, 90
Base Profile Cassette, 19'
\$12.20/ft.

See page 74 for end cap options in metal or plastic.

Mercury Roller Shade Finishes

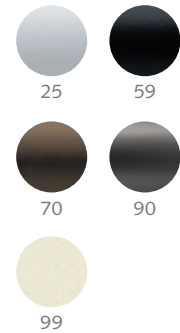
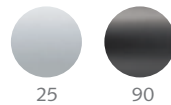
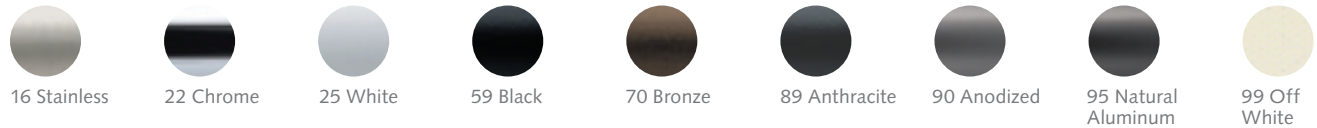

Mercury – Basic Mount

- Easy, simple installation
- Cover cap for screws
- Metal or plastic brackets



Mercury – Semi Open Mount

- Luxury installation cassette
- As a double, closes perfectly when blind is pulled down
- Almost no light gap on the top due to installation clip



ASSEMBLED PRICING:

LENGTH	WIDTH							
	24"	36"	48"	60"	72"	84"	96"	108"
24"	213.93	270.42	326.92	383.93	440.43	496.92	553.42	609.92
36"	239.66	283.94	343.27	403.13	449.24	506.87	564.49	622.13
48"	265.41	296.16	346.53	406.97	458.04	516.80	575.56	634.32
60"	291.15	321.91	352.66	410.80	462.45	526.74	586.64	
72"	316.90	347.66	378.41	409.68	468.62	536.69		
84"	342.64	373.39	404.15	435.41	473.26			
96"	368.38	399.14	429.89	461.16				
108"	394.13	424.88	455.64					

ASSEMBLED PRICING:

LENGTH	WIDTH							
	24"	36"	48"	60"	72"	84"	96"	108"
24"	231.54	291.90	352.26	413.13	473.50	533.86	594.23	654.58
36"	257.28	306.50	369.87	433.80	482.97	544.54	606.11	667.67
48"	283.03	317.65	373.40	437.92	492.44	555.22	617.99	680.77
60"	308.76	343.38	378.00	442.06	497.18	565.90	629.87	
72"	334.51	369.13	403.75	438.88	503.80	576.57		
84"	360.26	394.87	429.49	464.63	514.22			
96"	386.00	420.62	455.24	490.37				
108"	411.74	446.36	480.97					

Mercury – Basic Mount Components

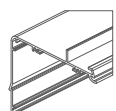

77004-25, 90
Base Profile Cassette, 19'
\$12.20/ft.

See page 74 for end cap options in metal or plastic.

Mercury – Semi Open Mount Components

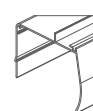

77008-25, 59, 70, 89, 99
Semi Open Cassette, 19'
\$15.30/ft.

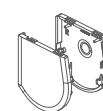

77007-25, 59, 70, 89, 99
Semi Open Cassette End Cap
\$7.61 ea.



MERCURY Decorative Roller Shades



CHILD SAFETY
PAGE 100

ASSEMBLED PRICING includes one of our six stock fabrics, choice of 38mm tube, roller mechanism, brackets, bracket covers, and counterweight or bottom rail with end cap. Side channels are additional. Add 10% for 42mm and 15% for 50mm. Freight is additional.

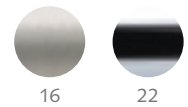
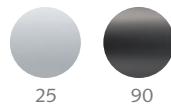

GREAT FEATURE!
Use the channel on the bottom of the profile to hang a sheer drapery!

Mercury – Square Mount

- Side guidance perfect for black-out
- Bottom bar sinks completely into cassette when shade is pulled up



MOTORIZED
PAGE 93

Mercury – Ultimate Mount

- Designer look
- A variety of metal finishes
- Matching bottom bar



MOTORIZED
PAGE 93

ASSEMBLED PRICING:

LENGTH	WIDTH							
	24"	36"	48"	60"	72"	84"	96"	108"
24"	261.95	337.31	412.67	488.53	563.89	639.25	714.61	789.96
36"	287.70	354.18	433.30	512.97	575.17	652.04	728.90	805.76
48"	313.45	363.06	437.43	517.85	586.45	664.82	743.19	821.56
60"	339.18	388.79	438.41	522.73	592.08	677.61	757.48	
72"	364.93	414.54	464.15	514.28	599.98	690.39		
84"	390.67	440.29	489.90	540.03	607.33			
96"	416.42	466.03	515.64	565.77				
108"	442.16	491.77	541.38					

ASSEMBLED PRICING:

LENGTH	WIDTH							
	24"	36"	48"	60"	72"	84"	96"	108"
24"	358.51	452.54	546.57	641.10	735.13	829.15	923.18	1,017.20
36"	384.26	475.17	573.89	673.16	749.83	845.73	941.64	1,037.55
48"	410.00	478.29	579.36	679.57	764.54	862.32	960.11	1,057.90
60"	435.74	504.02	572.30	685.99	771.89	878.90	978.57	
72"	461.49	529.77	598.05	666.84	782.18	895.48		
84"	487.23	555.51	623.79	692.59	791.31			
96"	512.98	581.26	649.54	718.34				
108"	538.71	606.99	675.28					

Mercury – Square Mount Components

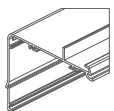

77004-25, 90
Base Profile Cassette, 19'
\$12.20/ft.



76022-25, 90
Square Cassette Cover, 19'
\$18.86/ft.

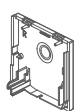

76023-25, 90
Square Cassette
End Cap, Right
\$4.21 ea.

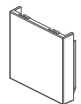

76024-25, 90
Square Cassette
End Cap, Right Chain
\$4.21 ea.

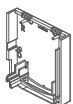

76025-25, 90
Square Cassette
End Cap, Left Chain
\$4.21 ea.

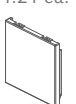

76048-25, 90
Square Cassette
End Cap, Left Chain
\$4.21 ea.

Mercury – Ultimate Mount Components

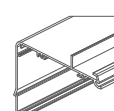

77004-90
Base Profile Cassette, 19'
\$12.20/ft.



77006-16, 22, 95
Ultimate Valance, 11'10"
\$31.97/ft.

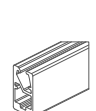

77005-16, 22, 95
Ultimate Bottom Rail
Square, 11'10"
\$12.36/ft.

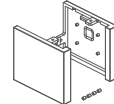

76028-16, 22, 95
Ultimate End Cap Set
\$67.64 ea.

Mercury Roller Shade Finishes

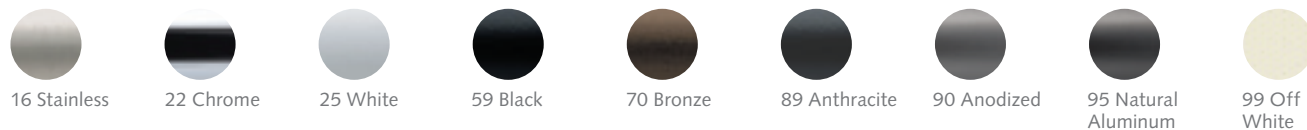

Mercury – Universal Components for all Mounting Types

					
77001-90 Aluminum Tube, 19' 50mm \$12.27/ft.	77002-90 Aluminum Tube, 19' 42mm \$8.77/ft.	77003-90 Aluminum Tube, 19' 38mm \$4.53/ft.	76003-25 Tube Adaptor 42mm \$1.43 ea.	76004- 25, 59, 70, 89, 99 Easy Mount Plug End 42mm \$2.87 ea.	76005- 25, 59, 70, 89, 99 Easy Mount Plug End 38mm \$2.26 ea.
					
77009- 25, 59, 70, 89, 90, 99 Double Roller Bottom Rail Tube \$10.15/ft.	76037- 16, 22, 95 End Cap for Double Roller Bottom Rail \$6.30/ft.	77005- 25, 59, 70, 89, 90, 99 Bottom Rail Square \$6.80/ft.	76021- 25, 59, 70, 89, 99 End Cap for Square Bottom Rail \$0.79 ea.	76002- 25, 59, 70, 89, 99 Fill up Ring \$1.27 ea.	76006- 25, 59, 70, 89, 99 End Cap Plastic \$2.39 ea.
					
76007- 16, 22, 23, 25, 62 End Cap Metal \$20.50 ea.	76008- 25, 59, 70, 89, 99 End Cap Recess Mount Plastic \$2.39 ea.	76009- 16, 22, 23, 25, 62 End Cap Recess Mount Metal \$20.50 ea.	76010- 25, 59, 70, 89, 99 Bracket Metal \$3.55 ea.	76011- 25, 59, 70, 89, 99 Screw Cap Plastic \$1.84 ea.	76012- 16, 22, 23, 25, 62 Screw Cap Metal \$9.68 ea.
					
76013- 25, 59, 70, 89, 99 Clutch Mechanism Plastic, 38mm \$19.13 ea.	76014- 16, 22, 23, 25, 62 Clutch Mechanism Metal, 38mm \$44.41 ea.	76015- 16, 22, 23, 25, 62 Clutch Mechanism Geared 1:5 Plastic, 38mm \$33.69 ea.	76016- 16, 22, 23, 25, 62 Clutch Mechanism Geared 1:1.5 Metal, 38mm \$54.60 ea.	76017- 25, 59, 70, 89, 99 Clutch Mechanism Geared 1:3 Plastic, 38mm \$33.69 ea.	76040-59 Roller Blind Mechanism Geared 1:15 38mm \$33.69 ea.
					
76018-90 Bracket Cassette Set Metal \$9.70 ea.	76019- 25, 59, 70, 89, 99 Installation Bracket Cassette \$6.90 ea.	76020-25, 90 Stability Block for Wall Mounting \$1.92 ea.	76029- 25, 59, 70, 89, 99 End Cap Set Day-n-Night Plastic \$16.95 ea.	76030- 25, 59, 70, 89, 99 Bracket Set Day-n-Night Metal \$57.73 ea.	76031- 25, 59, 70, 89, 99 Universal Bracket Day-n-Night Metal \$31.29 ea.
					
76032- 25, 59, 70, 89, 99 Intermediate Bracket w/ End Cap, Metal \$17.29 ea.	76033-59 Clip Mounting Support 42mm \$2.01 ea.	76035-00 Intermediate Connecting Pin, Flat \$18.10 ea.	76036-00 Intermediate Connecting Pin, Round \$18.10 ea.	76039-90 Brush for Cassette 4mm \$1.31 ea.	

CLIMATE SCREEN Insulating Roller Shades

Climate Screen by Forest offers a wide range of advanced daylight filter systems that are specially designed to minimize the entry of solar heat into a room. The unique features of the Climate Screen work bilaterally. In the summer the warmth will be kept out and in the winter the warmth will stay inside.

FOR USE IN:

Hotels, offices, homes, yachts, mobile homes and boats

BENEFITS:

- Optimum heat resistant effect
- Excellent insulating features
- Neutralize the heating effect of the sun's radiation
- Smooth and silent operation
- Available as a motorized or manually operated system
- Can be controlled by wall switch, remote control, etc.
- Easy to connect to automation systems
- Reduces energy costs
- Optimization of the work environment. Reduce reflection on computer monitors.
- Low maintenance. Highly durable and easy to clean.
- Is available with a wide range of options and finishes.



Climate Screen – Super Mini

- Left or right chain operation
- Extremely compact
- Mount inside or outside window casing
- Double sided tape can be used to mount inside metal or plastic window casings

ASSEMBLED PRICING:

		WIDTH				
		24"	36"	48"	60"	72"
LENGTH	24"	\$217.00	\$252.47	\$279.59	\$1,185.51	\$1,328.96
	36"	\$237.86	\$273.33	\$308.80	\$1,311.97	\$1,470.72
	48"	\$258.73	\$300.46	\$338.01	\$1,430.52	\$1,603.61
	60"	\$279.59	\$323.41	\$367.22	\$1,559.31	\$1,699.65
	72"	\$300.46	\$346.36	\$394.35	\$1,674.48	\$1,825.18



Climate Screen – Twin Mini

- Use the same or two different types of film
- Operation with two endless chains to control each film independently
- A blackout filter may be used

ASSEMBLED PRICING:

		WIDTH				
		24"	36"	48"	60"	72"
LENGTH	24"	\$356.79	\$411.04	\$459.03	\$509.11	\$2,101.98
	36"	\$390.18	\$448.60	\$504.93	\$567.53	\$2,343.21
	48"	\$423.56	\$490.33	\$555.01	\$619.69	\$2,558.56
	60"	\$459.03	\$529.97	\$603.00	\$682.29	\$2,817.01
	72"	\$492.41	\$571.70	\$648.90	\$746.97	\$3,084.06



Climate Screen Demo Units

Your Regional Sales Manager can bring in a Climate Screen demo to illustrate its great features. Demo units are also available for purchase.

- HANDHELD UNIT** \$100.00 each
- MOTORIZED UNIT** \$300.00 each

Climate Screen – Properties of Insulation



STANDARD SHADE FABRIC
75% of heat is transmitted
25% of heat is reflected



CLIMATE SCREEN MATERIAL
20.3% of heat is transmitted
79.7% of heat is reflected



CLIMATE SCREEN MATERIAL
100% of heat is retained

Climate Screen – Fabric Technical Data

FILM TYPE	BRONZE/SILVER		GREY/SILVER		WHITE/SILVER	SILVER/SILVER	
	60 in.	60 in.	65 in.	60 in.	60 in.	60 in.	60 in.
Film Width	60 in.	60 in.	65 in.	60 in.	60 in.	60 in.	60 in.
Item Number	2R-36680	10R-36660	2R-35540	10R-36620	OR-36790	2R-36630	10R-36610
Light Transmission Rate, %	2.5	9.0	4.0	7.0	2.0	2.2	14.6
Reflection Rate, %	79.0	64.0	69.0	56.0	88.7	81.0	64.0
Absorbtion Rate, %	18.5	26.0	28.0	37.0	10.4	16.5	21.0
UV Transmission, %	< 1	< 1	< 1	< 1	< 1	< 1	< 1
Total Energy Reflection	92.4	81.4	91.0	83.0	96.0	94.0	80.0
B Factor	0.10	.021	0.10	0.19	0.04	0.08	0.23
Heat Reflection	****	***	****	***	****	****	***
UV Protection	****	****	****	****	****	****	****
Transparency	***	***	***	***	-	***	***
Incidence of Light	****	***	****	***	*	****	***

**** Very Good *** Good ** Satisfactory * Adequate - Not Suitable

FILM TYPE	BRONZE/SILVER		GREY/SILVER		GREY/SILVER
	71.5 in.	71.5 in.	71.5 in.	71.5 in.	71.5 in.
Film Width	71.5 in.	71.5 in.	71.5 in.	71.5 in.	71.5 in.
Item Number	2R-38880	10R-38860	2R-38840	10R-38820	OR-38890
Light Transmission Rate, %	2.0	8.0	2.0	5.0	1.0
Reflection Rate, %	79.0	67.0	78.0	71.0	82.0
Absorbtion Rate, %	25.0	34.0	26.0	34.0	20.0
UV Transmission, %	0	0	0	0	0
Total Energy Reflection	92.0	81.0	91.0	83.0	96.0

FILM TYPE	GREY/GREY - 1R	GREY/GREY - 10R	BRONZE/BRONZE 10R
	71.5 in.	71.5 in.	71.5 in.
Film Width	71.5 in.	71.5 in.	71.5 in.
Item Number	99941	99920	99960
Light Transmission Rate, %	2.0	7.0	11.0
Reflection Rate, %	19.0	21.0	22.0
Absorbtion Rate, %	62.0	59.0	58.0
UV Transmission, %	0.1	0.1	0.1
Total Energy Reflection	46.0	49.0	49.0

Tracks, Metal, Wood and Shades . . . **FOREST MOTORIZATION**

From Tracks to Decorative Metal and Wood to Roller Shades, Forest can motorize your window treatments. All Forest Shuttle motors and the Forest Atlantis motor come with a 10 year warranty - the only one on the market. All other motors come with a 1 year warranty. Use our motors alone or in conjunction with your automation system.



Motorized Track System



Motorized Track System Plus



Motorized Roman Blind System



Motorized Blind System



Dresden

1 1/8" & 1 9/16" Motorized Metal Sets



Cordoba/Granada

2" & 2 3/4" Motorized Wood Sets



FOREST[®] Mercury

Motorized Decorative Roller Shades



FOREST[®] Atlantis

Motorized Heavy Duty Roller Shades



Forest Shuttle Family of Motors

Touch Impulse Technology opens or closes drapes with a gentle pull. Integrated emergency control insures manual operation of the drapery in case of power failure. The Shuttle modular motor allows for various control options including RF, wall switch, building/hotel automation, serial communication, Z-Wave, and others.

10 WARRANTY
year

All Forest Shuttle Motors include a 10-Year Warranty - the only one on the market.

Forest®
Eco Shuttle HD



Forest®
Eco Shuttle



Comparison Chart

	Forest Eco Shuttle HD (M)	Forest Eco Shuttle (S)
DIMENSIONS	Motor: 2.76" x 1.97" x 9" / Receiver Internal	Motor: 2.76" x 1.97" x 7.5" / Receiver Internal
MOUNTING	Wall or Ceiling; Can be spliced	Wall or Ceiling; Can be spliced
MAXIMUM WEIGHT	160 lbs per motor / 120 lbs per motor - curved track	100 lbs per motor / 90 lbs per motor - curved track
TRAVEL SPEED	5.5" per second standard / 7" per sec maximum	5.5" per second standard / 7" per sec maximum
RECEIVER	Internal	Internal
AMPERAGE	.6 amps / 70 watts / 110 volt plug-n-play	.35 amps / 40 watts / 110 volt plug-n-play
TORQUE	1.5 Nm	1.0 Nm
NOISE LEVEL	< 40 dB(A)	< 40 dB(A)
TOUCH IMPULSE TECHNOLOGY	✓	✓
EMERGENCY CONTROL	✓	
RF COMMUNICATION STANDARD	✓	w/ dry contacts ✓
Z-WAVE COMMUNICATION		✓
AUTOMATION SYSTEM COMPATIBLE	w/ dry contacts ✓	w/ dry contacts ✓
10-YEAR WARRANTY	✓	✓

SPECS

FEATURES

MOTORIZATION – Shuttle Motors

Choose your Shuttle & pair with one of these systems:

FMS Track P. 81



FMS Plus Track P. 83



Metal P. 87



Wood P. 91



Load Tables

— Straight — One Bend/Curve — Two Bends

ECO Shuttle HD (M) and Z-WAVE Shuttle

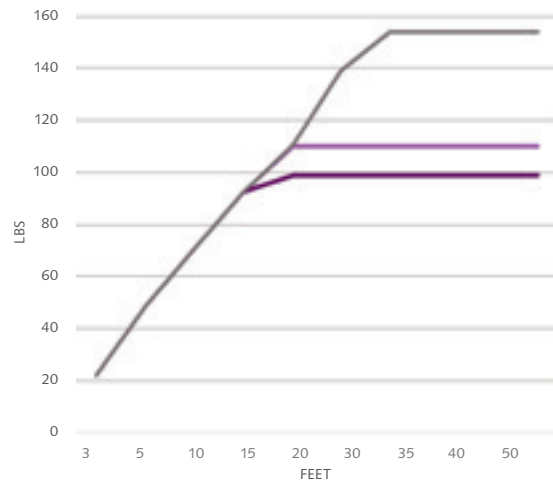

ECO SHUTTLE (S)

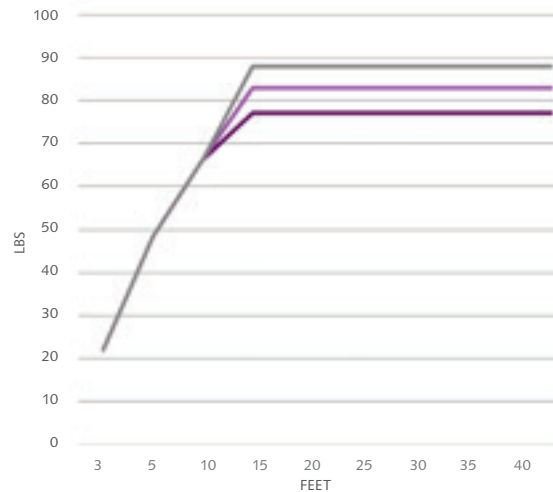

Forest

Z-Wave Shuttle

Motor: 2.76" x 1.97" x 9" / Receiver Internal

Wall or Ceiling; Can be spliced

160 lbs per motor / 120 lbs per motor - curved track

5.5" per second standard / 7" per sec maximum

Internal

.6 amps / 70 watts / 110 volt plug-n-play

1.5 Nm

< 40 dB(A)

✓

✓

✓

✓

✓

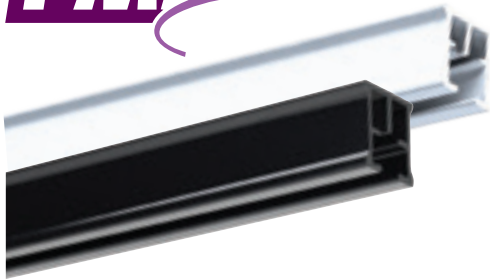

FMS® - Forest Motorized System

The original motorized track from Forest will hold 6 lbs/ft and provides ultra-quiet and smooth operation of your draperies. Aluminum extrusion, powder coated. Wall or ceiling mount. Available in -25 white and -59 black.

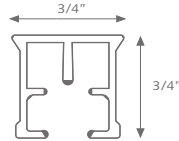

51323-25
-59 Black +10%
23' aluminum extrusion, powder coated, lubricated FS track
\$5.21/ft. 10/bundle

ASSEMBLED PRICING includes track, motor, power supply, and Diamond remote or wall switch. Add 10% for black. Freight is additional.



BEND/CURVE
PAGE 21



FMS Track with Forest Eco-Shuttle HD:
First 4 feet = \$1,744.10, Each add'l foot = \$27.53. Add 10% for black motor, track & components.



FMS Track with Forest Eco-Shuttle:
First 4 feet = \$1,585.54, Each add'l foot = \$27.53.



FMS Track with Forest Z-Wave Shuttle:
First 4 feet = \$1,924.87, Each add'l foot = \$27.53.

BREAK PACK PRICING - Prices with this designation indicate a 20% up charge for broken pack quantities.

FMS Motors, Power Supplies and Control Options



52925-25
Forest Eco Shuttle HD
-59 Black +10%
w/ built-in receiver
\$996.10 ea. 1/box



52939-25
Forest Eco Shuttle
w/ built-in receiver
\$806.82 ea. 1/box



52944-25
Forest Z-Wave Shuttle
w/ built-in receiver
\$1,354.14 ea. 1/box

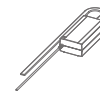

52928-25 7' 6" power cord
52934-25 16' power cord
24 v Power Supply
for Eco HD & Z-Wave Shuttles
\$126.66 ea. 1/box

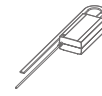

52940-25
24 v Power Supply
for Eco Shuttle ONLY
7' power cord
\$126.66 ea. 1/box



52931-25D white
52931-59D black
-59 Black +10%
Diamond Remote
RF, 6 channel w/ holder
Range 98'
\$208.73 ea. 1/box



52933-25 white
52933-59 black
-59 Black +10%
Diamond Wall Switch
2 channel
\$159.06 ea. 1/box



52943-25 white
52943-59 black
-59 Black +10%
RF Multi Wall Switch
16 channel
LED Screen
\$273.84 ea. 1/box
NOT PART OF ASSEMBLED SET

FMS Transport Components



9012-25
Transport Belt
Kevlar reinforced
\$10.43/ft.
\$8.69/ft. 328 ft./roll



52512-25
-59 Black +10%
Transport Belt Connector
Connects belt to master
\$10.81 ea.
\$9.01 ea. 50/box



52903-25
-59 Black +10%
Motor Pulley
Connects motor to track
\$85.30 ea. 1/box



52910-25
-59 Black +10%
Return Pulley
\$31.85 ea. 1/box

FMS Carriers



52008-25
-59 Black +10%
Slim Line Klick Carrier
Draperies hang to
conceal track
\$0.97 ea.
\$0.80 ea./box of 250



52009-25
Ball Bearing Carrier
for motorization
\$1.36 ea.
\$1.14 ea./box of 250



2114-25 60% fullness, 2 5/8" OC
2111-25 80% fullness, 2 3/8" OC
2112-25 100% fullness, 2 1/8" OC
2115-25 120% fullness, 1 7/8" OC
-59 Black +10%
Two-Piece Connected Snap Carrier w/ Square Base
In plastic sleeve. Use 4 1/4" snap tape.
\$1.10 ea.
\$0.92 ea./roll of 500

FMS Masters

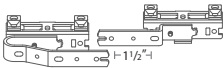

52508-25 Overlap R
52509-25 Underlap L
-59 Black +10%
Swivel Foot
Multi-Functional Master
\$11.55 ea.
\$9.62 ea./box of 100

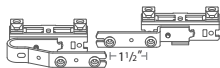

52508-25A Overlap R
52509-25A Underlap L
-59 Black +10%
Swivel Foot
Multi-Functional Master
w/ snap
\$13.69 ea.
\$11.41 ea./box of 100



52409-25 Butt L
52410-25 Butt R
Butt Master
w/ 3 snaps for Ripplefold*
\$15.90 ea.
\$13.25 ea./box of 50



2552-25
6" Extension Arm
For master
Use w/ two
\$3.89 ea.
\$3.24 ea./box of 50



2551-25
Small Extension Arm
\$3.90 ea.
\$3.25 ea./box of 50

FMS Brackets and Other Components



3003-25
-59 Black +10%
HD Ceiling Bracket
w/ Smart Klick
\$1.97 ea.
\$1.64 ea./box of 100



53202-25
-59 Black +10%
3" Smart Klick Wall Bracket
w/ wide base
adjusts 3"-4 1/2"
\$2.91 ea.
\$2.43 ea./box of 100

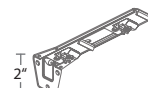

53206-25
-59 Black +10%
6" Smart Klick
Double Wall Bracket
w/ wide base
adjusts 2 1/2"-4" & 6"-7.5"
\$4.78 ea.
\$3.98 ea./box of 50



3006-25
Suspension Bracket Tube
39" extension
\$111.34 ea. 10/box



3007-25
Suspension Bracket
Insert Screw
\$7.20 ea.
\$6.00 ea./box of 100



3008-25
Suspension Bracket Top
\$40.18 ea.
\$33.48 ea./box of 25



3009-25
Suspension Bracket
Klick System Clip
\$2.22 ea.
\$1.85 ea./box of 50



3903-25
-59 Black + 10%
Track Connector and
key **3904-00**
\$16.68 ea.
\$13.90 ea./box of 10



FMS® Plus - Forest Motorized System Plus

This completely new motorized track makes it possible to create even longer treatments and will hold 8 lbs/ft. Just as the original Forest Motorized track provides ultra-quiet and smooth operation of your draperies, so does the FMS Plus track. White aluminum extrusion, powder coated. Wall, ceiling or recess mount.

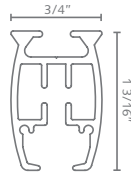

51623-25 white 23' x 10 tracks/bundle =230'
\$11.06/ft.

ASSEMBLED PRICING includes track, motor, power supply, and Diamond remote or wall switch. Freight is additional.

FMS Plus Track with Forest Eco-Shuttle HD:
First 4 feet = \$1,878.39, Each add'l foot = \$68.39



FMS Plus Track with Forest Eco-Shuttle:
First 4 feet = \$1,750.40, Each add'l foot = \$68.39



FMS Plus Track with Forest Z-Wave Shuttle:
First 4 feet = \$2,059.17, Each add'l foot = \$68.39



BREAK PACK PRICING - Prices with this designation indicate a 20% up charge for broken pack quantities.

FMS Plus Motors, Power Supplies and Control Options



52925-25
Forest Eco Shuttle HD
-59 Black +10%
w/ built-in receiver
\$996.10 ea. 1/box



52939-25
Forest Eco Shuttle
w/ built-in receiver
\$806.82 ea. 1/box



52944-25
Forest Z-Wave Shuttle
w/ built-in receiver
\$1,354.14 ea. 1/box



52928-25 7' 6" power cord
52934-25 16' power cord
24 v Power Supply
for Eco HD & Z-Wave Shuttles
\$126.66 ea. 1/box

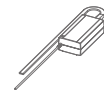

52940-25
24 v Power Supply
for Eco Shuttle ONLY
7' power cord
\$126.66 ea. 1/box



52931-25D white
52931-59D black
-59 Black +10%
Diamond Remote
RF, 6 channel w/ holder
Range 98'
\$208.73 ea. 1/box



52933-25 white
52933-59 black
-59 Black +10%
Diamond Wall Switch
2 channel
\$159.06 ea. 1/box



52943-25 white
52943-59 black
-59 Black +10%
RF Multi Wall Switch
16 channel, LED Screen
\$272.84 ea. 1/box
NOT PART OF ASSEMBLED SET

FMS Plus Transport Components

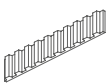

9112-25
Transport Belt
\$6.64/ft.
\$5.53/ft. /roll of 328 ft.



53903-25
Motor Pulley
Connects motor to track
\$72.46 ea. 1/box



53910-25
Return Pulley
\$36.22 ea. 1/box



53911-25
Upside Down Pulley
\$72.46 ea. 1/box



53912-25
Coverplate
for Recess Motor
and Return Pulley
\$3.95 ea. 1/box



53913-25
Coverplate
for Recess,
Upside Down,
and Return Pulley
\$3.32 ea. 1/box

FMS Plus Carriers



52008-25
Slim Line Klick Carrier
Draperies hang to
conceal track
\$0.97 ea.
\$0.80 ea./box of 250



52004-25 OR 52009-25
Low Profile
Ball Bearing Carrier
\$1.36 ea.
\$1.14 ea./box of 1000
52009-25
Ball Bearing Carrier
for motorization
\$1.36 ea.
\$1.14 ea./box of 250



2114-25 60% fullness, 2 5/8" OC
2111-25 80% fullness, 2 3/8" OC
2112-25 100% fullness, 2 1/8" OC
2115-25 120% fullness, 1 7/8" OC
Two-Piece Connected Snap Carrier w/ Square Base
In plastic sleeve. Use 4 1/4" snap tape.
\$1.10 ea.
\$0.92 ea./roll of 500

FMS Plus Master

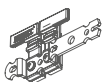

53908-25 Overlap Right
FMS Plus Master Carrier
\$34.83 ea.
\$29.03 ea./box of 10

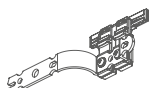

53909-25 Underlap Left
FMS Plus Master Carrier
Assembly required
\$30.44 ea.
\$25.37 ea./box of 10

FMS Plus Brackets



3003-25
HD Ceiling Bracket
w/ Smart Klick
\$1.97 ea.
\$1.64 ea./box of 100

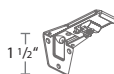

53202-25
3" Smart Klick Wall Bracket
w/ wide base
adjusts 3"-4 1/2"
\$2.91 ea.
\$2.43 ea./box of 100

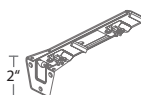

53206-25
6" Smart Klick
Double Wall Bracket
w/ wide base
adjusts 2 1/2"-4" & 6"-7.5"
\$4.78 ea.
\$3.98 ea./box of 50



3800-25
MTS Wall Bracket
To install the rod inside a frame
\$23.24 ea.
\$19.36 ea./box of 20



3006-25
Suspension Bracket Tube
39" extension
\$111.34 ea. 10/box



3007-25
Suspension Bracket
Insert Screw
\$7.20 ea.
\$6.00 ea./box of 100



3008-25
Suspension Bracket Top
\$40.18 ea.
\$33.48 ea./box of 25



3009-25
Suspension Bracket
Klick System Clip
\$2.22 ea.
\$1.85 ea./box of 50

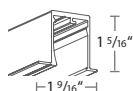

51723-25
Recess Profile, 23'
\$14.63/ft.



51724-25
Recess Profile Fixing Strip, 23'
\$3.08/ft.



53914-25
Recess Profile Wedge
\$4.30 ea.
\$3.58 ea./box of 10

RBS[®]
Motorized



CHILD SAFETY
PAGE 100

10 WARRANTY
year

The Forest RBS tubular motor has a 10-year warranty; Lithium a 1-year warranty.

Motorized RBS[®] - Roman Blind System

Most durable and functional roman blind hardware on the market.
The motorized option is best suited to light weight applications.
White aluminum extrusion, powder coated. Wall or ceiling mount. Integrated velcro tape.

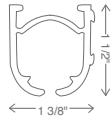

41019-25 white 19' x 10 tracks/bundle = 190'
\$6.84/ft.

RBS MOTORIZED ASSEMBLED PRICING - please specify wall or ceiling mount, number of cord roll supports, remote or wall switch and any other components needed. Counterweights will be sent only on request and at no extra charge.

With Standard Motor:
\$683.76 for the first 3 feet, \$2.51/additional inch. Freight is additional.
With Lithium Battery Motor:
\$714.65 for the first 3 feet, \$2.51/additional inch. Freight is additional.

BREAK PACK PRICING - Prices with this designation indicate a 20% up charge for broken pack quantities.

APPLICATION	SHADE STYLE	MOUNTING	MAX WEIGHT
Motorized	Roman Balloon	Wall Ceiling	10 lbs

RBS Motorized Components

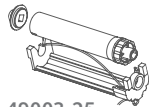

49003-25
Cord Roll Support w/ Cord
12' drop length
\$4.91 ea.
\$4.09/box of 100

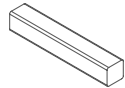

41119-90
19' Rod
aluminum 3/16" x 3/16"
\$2.42/ft.
\$2.02/ft. for bundle of 5

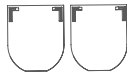

62913-25
RBS End Caps
left & right
\$1.83 ea.
\$1.53 ea./box of 50

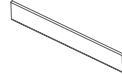

49005-25
Counterweight, 19'
aluminum 1" x 1/8"
\$2.24/ft.
\$1.79/ft. for bundle of 20



43202-25
Swivel Wall Bracket
\$2.05 ea.
\$1.71 ea./box of 100



43003-25
Swivel Ceiling Bracket
\$2.32 ea.
\$1.93 ea./box of 100

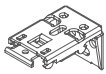

43033-25
Klick Wall Bracket
\$2.32 ea.
\$1.93 ea./box of 200

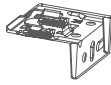

43034-25
Hidden Klick Multi Bracket
\$2.32 ea.
\$1.93 ea./box of 100

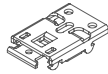

43004-25
Klick Ceiling Bracket
\$2.32 ea.
\$1.93 ea./box of 100



49008-25
Shade Leveler
\$0.50 ea.
\$0.42 ea./box of 1000



31116-25
Velcro Profile w/
Hook Tape, 13.1'
\$4.22/ft.
\$3.52/ft. /bundle of 20

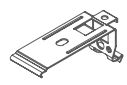

49090-25
Valance Bracket
attaches to velcro profile
\$2.66 ea.
\$2.22 ea./box of 50



49091-25
Valance Corners
\$3.88 ea.
\$3.23 ea./box of 250



39007-25
Velcro Tape
27 yds. per roll
\$25.19/roll

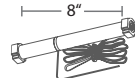

62903-25
RBS Tubular Motor, 24 V
Double Shaft
Lifts up to 10 lbs.
\$290.43 ea. 1/box



52940-25
24 v Power Supply
7' power cord
\$126.66 ea. 1/box



52931-25D white
52931-59D black
-59 Black +10%
Diamond Remote
RF, 6 channel w/ holder
\$208.73 ea. 1/box



52933-25 white
52933-59 black
-59 Black +10%
Diamond Wall Switch
\$159.06 ea. 1/box

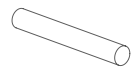

49006-25
Fiberglass Spines, 19'
3/16" diameter
\$0.56/ft.
\$0.40/ft. for bundle 250



49014-25
Plastic Snap Ring
\$0.11 ea.
\$0.09 ea./box of 5000



49400-25
Shroud
73 yds. per roll
\$220.44/roll

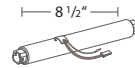

62910-25
RBS Tubular Lithium
Motor, 1-year warranty
24 V, includes plug
\$382.81 ea. 1/box



62911-25
Remote for Lithium
Motor
15 channel w/ holder
\$65.08 ea. 1/box



62912-25
Lithium Battery
& Adaptor
\$210.54 ea. 1/box



CHILD SAFETY
PAGE 100

10
WARRANTY
year

The Forest BCS tubular motor has a 10-year warranty.

BCS[®] - Blind Contract System

A motorized blind system for medium to heavy weight applications. Ultra quiet and easy to install.

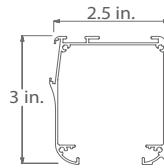

61019-25 white 19' aluminum extrusion
\$11.33/ft.

BCS MOTORIZED ASSEMBLED PRICING - please specify wall or ceiling mount, number of cord roll supports, remote or wall switch and any other components needed. Counterweights will be sent only on request and at no extra charge.

\$1,108.03 for the first 3 feet, \$78.29/additional foot. Freight is additional.

BREAK PACK PRICING - Prices with this designation indicate a 20% up charge for broken pack quantities.

APPLICATION	SHADE STYLE	MOUNTING	MAX WEIGHT
Motorized	Roman Balloon	Wall Ceiling	8.75 lbs./cord roll 45 lbs./motor

BCS Components



61119-25
BCS 8-Angle Tube, 19'
\$4.76/ft.

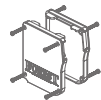

62309-25
BCS End Caps
left & right
\$5.56 ea.
\$4.63 ea./box of 25



63001-25
BCS Klick Bracket
Wall/Ceiling Bracket
\$16.31 ea.
\$13.59 ea./box of 25



62100-25
BCS Center Support
2" x 2.25"
\$16.22 ea.
\$13.52 ea./box of 25

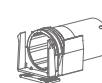

62000-25
BCS Cord Roll House
& Drum
contains 18' cord
\$55.53 ea.
\$46.27 ea./box of 25



49008-25
BCS Snap Cord Leveler
to adjust counterweight
\$0.50 ea.
\$0.42 ea./box of 1000



62200-25
BCS Tube Support
place on open end of tube
\$28.05 ea.
\$23.37 ea./box of 25



61125-25
BCS Velcro
7/8" x 4'
\$14.87/ft.
\$12.39/ft. for bundle
of 25



49006-25
Fiberglass Rod, 19'
\$0.56/ft.
\$0.40/ft. for bundle
of 250

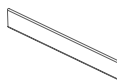

49005-25
BCS Counterweight, 19'
aluminum 1" x 1/8"
\$2.24/ft.
\$1.79/ft. for bundle of 20



49400-25
Shroud
73 yds. per roll
\$220.44/roll

BCS Motor and Control Options

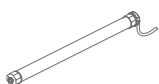

62901-25
Forest Tubular Motor
built-in RF receiver,
35mm (1 3/8"), 110v, 6 Nm
\$549.32 ea. 1/box



52931-25D white
52931-59D black
-59 Black +10%
Diamond Remote
RF, 6 channel w/ holder
\$205.73 ea. 1/box



52933-25 white
52933-59 black
-59 Black +10%
Diamond Wall Switch
\$159.06 ea. 1/box

Dresden Motorized Collection

1 1/8" and 1 9/16" Motorized Sets



NEW SIZE!

Available Finishes XX = finish color

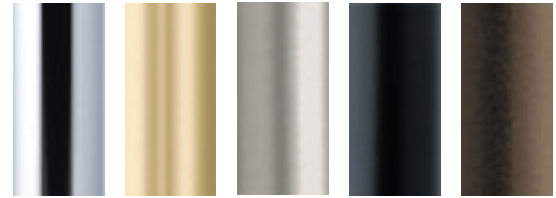

22 Polished Chrome
24 Satin Brass
29 Satin Nickel
59 Black
70 Matte Bronze

NEW!

ASSEMBLED PRICING includes rail, single wall brackets, motor, power supply, and Diamond wall switch or remote. Finials for 1 1/8" are additional and should be ordered separately. Freight is additional.

With Forest Eco Shuttle HD:

1 1/8" First 4 feet = \$2,672.32, 1 1/8" Each add'l foot = \$111.89
1 9/16" First 4 feet = \$2,997.23, 1 9/16" Each add'l foot = \$118.02
Surcharge for black motor = \$88.76

With Forest Eco Shuttle:

1 1/8" First 4 feet = \$2,619.93, 1 1/8" Each add'l foot = \$111.89
1 9/16" First 4 feet = \$2,807.95, 1 9/16" Each add'l foot = \$118.02

With Forest Z-Wave Shuttle:

1 1/8" First 4 feet = \$2,847.85, 1 1/8" Each add'l foot = \$111.89
1 9/16" First 4 feet = \$3,355.27, 1 9/16" Each add'l foot = \$118.02

Single wall brackets are included.

(deduct \$32/bracket for ceiling brackets):

0'-5'=2 brackets 6'-10'=3 brackets
11'-15'=4 brackets 16'-20'=5 bracket

Motor Options



All Shuttle motors have a 10-year warranty. To determine which Shuttle motor is right for your job, see pages 79-80.



52925-25
-59 Black +10%
Forest Eco Shuttle HD, w/ built-in receiver
\$976.25 ea. 1/box



52939-25
Forest Eco Shuttle, w/ built-in receiver
\$806.82 ea. 1/box



52944-25
Forest Z-Wave Shuttle, w/ built-in receiver
\$1,354.14 ea. 1/box

Control Options - Dresden Motorized



52931-25D white
52931-59D black
-59 Black,+10%
Diamond Remote, Range 98'
RF, 6 channel w/ holder
\$208.73 ea. 1/box



52933-25 white
52933-59 black
-59 Black +10%
Diamond Wall Switch
2 channel
\$159.06 ea. 1/box



52943-25 white
52943-59 black
-59 Black +10%
RF Multi Wall Switch
16 channel, LED Screen
\$272.84 ea. 1/box, Not part of assembled set

Finials - 1 1/8" Dresden Motorized FINIALS FOR 1 1/8" ONLY. FINIALS ARE OPTIONAL AND SHOULD BE ORDERED SEPARATELY.

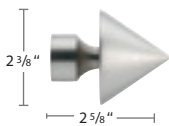

B3356-XX
Riva Finial
\$198.73 ea.

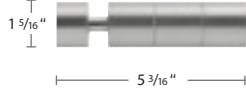

B690-XX
Pescara Finial
\$237.88 ea.

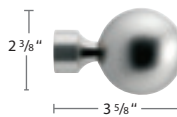

B3362-XX
Alassio Finial
\$240.87 ea.

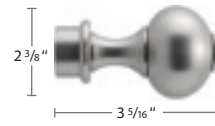

B650-XX
Verona Finial
\$326.34 ea.



B610-XX
Napoli Finial
\$299.15 ea.

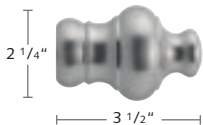

B129328-XX
Allesandria Finial
\$112.59 ea.



B660-XX
Roma Finial, no 59 Black
\$422.05 ea.

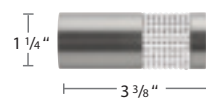

B315-28-XX
Largo Finial
\$338.71 ea.

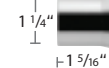

B3389/1-XX
Socket for Ardea Finial
\$80.91 ea.



B3389-100
Ardea Finial
\$402.37 ea.

1 1/8" Dresden Motorized Components



B809-28-XX
1 1/8" Aluminum Rail
for Motorization, 19' 7"
\$43.37/ft.

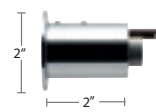

B11682-XX
Recess Bracket
with Return Pulley
\$210.78 ea.

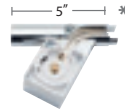

B11679-L-XX
Left Motor Pulley
B11679-R-XX
Right Motor Pulley
\$496.82 ea.

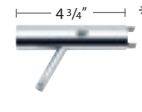

B11683-L-XX
Left Return Pulley
B11683-R-XX
Right Return Pulley
\$225.84 ea.

*
Motor Pulley width
in -70 = 4 3/4"

Return Pulley width
in -70 = 4 3/4"

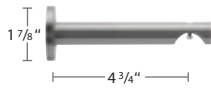

B11670-120-XX
Single Bracket
\$140.71 ea.

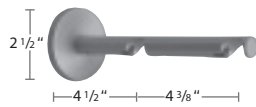

B11672-220-XX
Double Bracket
\$159.59 ea.

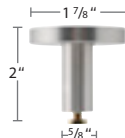

B11873-50-XX
Ceiling Bracket
\$96.35 ea.

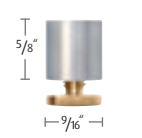

B11873-15-XX
Ceiling Bracket
5/8" Extension
\$51.19 ea.

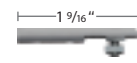

B11592-00
Flush Ceiling Bracket
Cannot use finials
\$21.90 ea.

1 9/16" Dresden Motorized Components CHOOSE A SATIN NICKEL OR BLACK FINISH, NO FINIALS AVAILABLE FOR 1 9/16".

NEW SIZE!



B809-40-29, 59
1 9/16" Aluminum Rail
for Motorization, 19' 7"
\$47.29/ft.



B11679-L-40-29, 59
Left Motor Pulley
B11679-R--40-29, 59
Right Motor Pulley
\$522.53 ea.

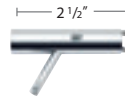

B11683-L-40-29, 59
Left Return Pulley
B11683-R--40-29, 59
Right Return Pulley
\$242.41 ea.

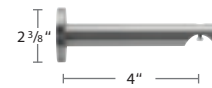

B40970-29, 59
Single Bracket
\$142.65 ea.

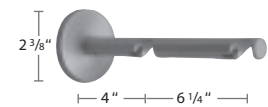

B340972-29, 59
Double Bracket
\$159.59 ea.

Common Components - 1 1/8" & 1 9/16" Dresden Motorized



52008-25
-59 Black, -65 Brown +10%
Slim Line Contract Klick®
shape helps pleats hang straight
\$0.97 ea.
\$0.80 ea./box of 250



2114-25 60% fullness, 2 5/8" OC
2111-25 80% fullness, 2 3/8" OC
2112-25 100% fullness, 2 1/8" OC
2115-25 120% fullness, 1 7/8" OC
-59 Black + 10%

Two-Piece Connected Snap
Carrier w/ Square Base
in plastic sleeve.
Use 4 1/4" snap tape.
\$1.10 ea.
\$0.92 ea./roll of 500



52009-25
Ball Bearing Carrier
for motorization
\$1.36 ea.
\$1.14 ea./box of 100

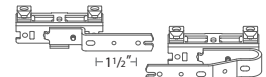

52508-25 Overlap R
52509-25 Underlap L
-59 Black, -65 Brown +10%
Belt Master Carrier
\$11.55 ea.
\$9.62 ea./box of 100

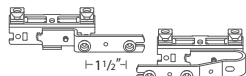

52508-25A Overlap R
52509-25A Underlap L
-59A Black, -65A Brown +10%
Belt Master Carrier w/ snaps
\$13.69 ea.
\$11.41 ea./box of 100



52409-25 Butt L
52410-25 Butt R
Standard Butt Master w/ snaps
\$15.90 ea.
\$13.25 ea./box of 50



2552-25
6" Extension Arm for master
Use w/ 2 one-way draws
\$3.89 ea.
\$3.24 ea./box of 50

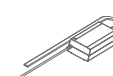

52940-25
Eco Shuttle Power Supply
24 v
7' power cord
for Eco Shuttle ONLY
\$126.66 ea. 1/box

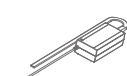

Eco & Z-Wave Shuttle
Power Supply
24 v
52928-25 7' 6" power cord
52934-25 16' power cord
\$126.66 ea. 1/box



9012-25
Transport Belt, Kevlar reinforced
\$10.43/ft.
\$8.69/ft. for roll 328 feet

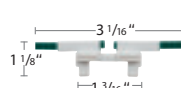

52512-25
-59 Black, +10%
Transport Belt Connector, connects belt to master
\$10.81 ea.
\$9.01 ea./box of 100

Dresden Motorized Collection

1 1/8" MOTORIZED H-RAIL SETS

WEAR-RESISTANT PULLEY HOUSING

For low wear operation the pulley housing has been equipped with high quality ball bearings.



REINFORCED BELT

The Kevlar reinforced belt runs quietly and has superior longevity.

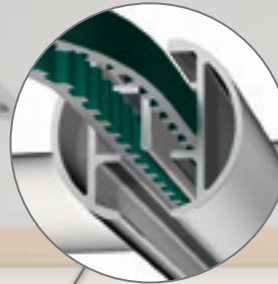

FOREST SHUTTLE MOTORS

- Touch Impulse Technology opens or closes drapes with a gentle pull.
- Integrated emergency control insures manual operation of the drapery in case of power failure.
- Choose the Forest Eco Shuttle for light weight fabrics.
- Choose the Forest Eco Shuttle HD for strength and an economical price.
- Choose the Forest Z-Wave Shuttle to integrate with your automation system.
- See pages 79-80 for a comparison chart to help you choose the motor best suited to your job.
- All Forest Shuttle drapery motors come with a 10-year warranty.



REMOTE CONTROL

Easy opening and closing of draperies with the hand-held remote.



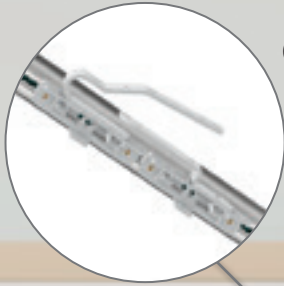

COMPLETELY CLOSED DRAPERIES USING OVERLAP MASTERS

The overlap master carrier guarantees a complete 3" overlap of the draperies. Extended arms available.

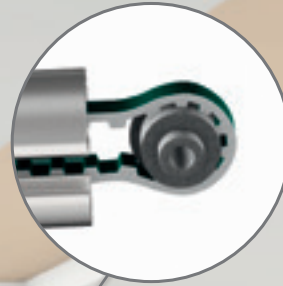

RETURN PULLEY

The return pulley is made of a special plastic and uses a bearing which creates smooth operation.

SELECT YOUR INDIVIDUAL FINIAL

Our decorative finials offer a variety of design options. See page 85 for finial options for 1 1/8" only.

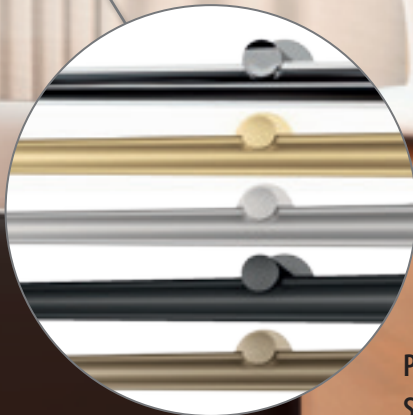
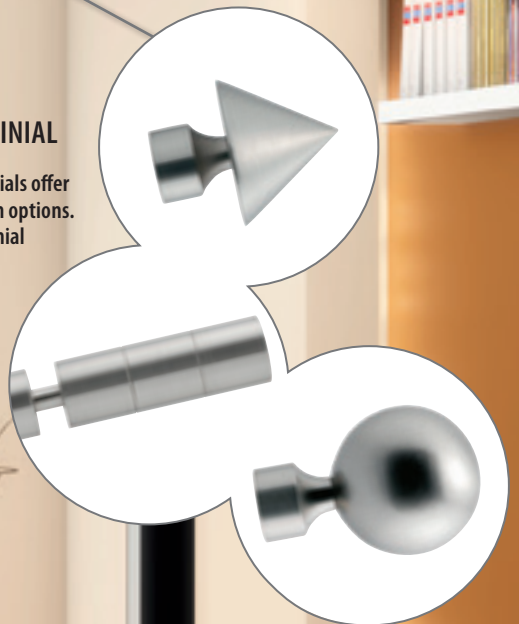

HIGH-GRADE ALUMINUM:

We supply the special 1 1/8" rails with the finishes below. 1 9/16" rails are available in -29 Satin Nickel and -59 Black.

Polished Chrome - 22



Satin Brass - 24



Satin Nickel - 29



Black - 59



Matte Bronze - 70



Motorized 2" Cordoba and 2 3/4" Granada

FMS Track with Wood Pole Fascia motorized with the Forest Shuttle

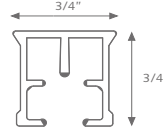

51323-25
-59 Black +10%
23' aluminum extrusion, powder coated, lubricated FMS track



ASSEMBLED PRICING includes wood pole fascia, assembled track, brackets, customer's choice of finials, motor, power supply, and Diamond remote or wall switch. See pages 79-80 for motor specs. Freight is additional.



10 WARRANTY **year**

All Forest Shuttle motors include a 10-Year Warranty. To determine which Shuttle motor is right for your job, see pages 79-80.

	Eco first 4 feet	Eco HD first 4 feet	Z-Wave first 4 feet	All ea. add'l ft.
2" Single Unfinished	\$1,656.10	\$1,810.45	\$2,000.27	\$50.72
2" Single Finished	\$1,708.61	\$1,862.96	\$2,052.78	\$61.74
2" Double Unfinished	\$3,295.24	\$3,449.59	\$3,829.22	\$90.41
2" Double Finished	\$3,355.55	\$3,509.90	\$3,891.74	\$95.92
2 3/4" Single Unfinished	\$1,708.49	\$1,862.84	\$2,052.66	\$63.95
2 3/4" Double Unfinished	\$3,463.83	\$3,618.18	\$3,997.79	\$106.94

2" Cordoba Available Finishes XX = finish color / *Not all components are stocked in Antiqued finishes. Please call for availability.

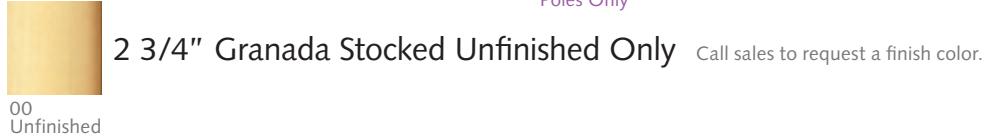

Motorized 2" Cordoba and 2 3/4" Granada Finials

Additional finials can be found on page 57 (2" Cordoba) and page 59 (2 3/4" Granada).



MOTORIZATION - Wood

Motorized 2" Cordoba and 2 3/4" Granada Smooth or Reeded Poles



1051RSW-XX
2" CORDOBA Smooth
Stock Length: 14'

1072RSW-00
2 3/4" GRANADA Smooth
Stock Length: 13'



1051RRW-XX
2" CORDOBA Reeded
Stock Length: 14'

1072RRW-00
2 3/4" GRANADA Reeded
Stock Length: 13'

Motorized 2" Cordoba and 2 3/4" Granada Components



52925-25
Forest Eco Shuttle HD
-59 Black
w/ built-in receiver



52939-25
Forest Eco Shuttle
w/ built-in receiver



52944-25
Forest Z-Wave Shuttle
w/ built-in receiver



52928-25 7' 6" power cord
52934-25 16' power cord
24 v Power Supply
for Eco HD & Z-Wave Shuttles



52940-25
24 v Power Supply
for Eco Shuttle ONLY
7' power cord



52931-25D white
52931-59D black
Diamond Remote
RF, 6 channel w/ holder
Range 98'



52933-25 white
52933-59 black
Diamond Wall Switch
2 channel



52943-25 white
52943-59 black
RF Multi Wall Switch
16 channel, LED Screen
NOT PART OF ASSEMBLED SET



9012-25
Transport Belt
Kevlar reinforced

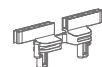

52512-25
-59 Black
Transport Belt Connector
Connects belt to master



52903-25
-59 Black
Motor Pulley
Connects motor to track



52910-25
-59 Black
Return Pulley



52008-25 white
-59 Black
Slim Line Contract Klick®
helps pleats hang straight



52009-25
Ball Bearing Carrier
for motorization

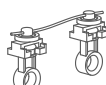

2114-25 60% fullness, 2 5/8" OC
2111-25 80% fullness, 2 3/8" OC
2112-25 100% fullness, 2 1/8" OC
2115-25 120% fullness, 1 7/8" OC
-59 Black
2-Piece Connected Snap Carrier
w/ Square Base, use 4 1/4" snap tape

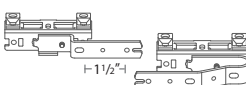

52508-25 Overlap R
52509-25 Underlap L
-59 Black
Belt Master Carrier

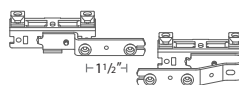

52508-25a Overlap R
52509-25a Underlap L
-59 Black
Belt Master Carrier
w/ snap



52409-25 Butt L
52410-25 Butt R
Butt Master
w/ 3 snaps for Ripplefold



2551-25
Small Extension Arm



2552-25
6" Extension Arm for Master
Use w/ two one way draws



3903-25
-59 Black
Track Connector
includes Key 3904-00



3280-25
-59 Black
3" Single Wall Bracket
heavy duty
projection 2 1/2"



3281-25
-59 Black
6" Double Wall Bracket
heavy duty
projection 1 1/2", 5 1/2"

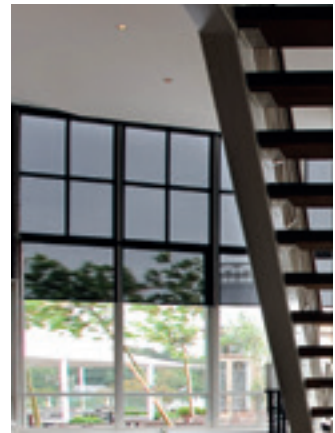
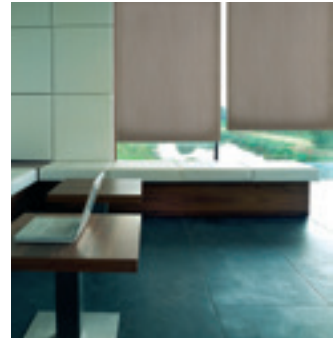

Mercury Motorized Roller Shade Features

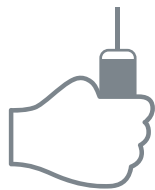

Pull Tab

Operate shades with a pull tab (included) and add an optional decorative baton or tassel. A great feature when the remote or cannot be accessed.



Bi-directional App

Operate shades with a bi-directional app available for download.

Mercury Motorized Decorative Roller Shades *NEW!*



Tubular motorized roller shade system in 38, 42 or 50 mm with internal multi receiver. Featured and in stock is the 3Nm motor. For information on a 5Nm option, call sales. Battery is lithium and rechargeable. Battery performs 300-400 revolutions per 8 hour charge. Can be operated by wall switch, remote, pull tab or bi-directional app.

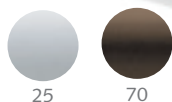

Mercury Motorized Large Fascia Double

ASSEMBLED PRICING includes one of our six stock fabrics, two 38mm tubes, 2 motors, micro usb cable to charge battery, brackets, bracket covers, counterweight or bottom rail with end cap and remote. Side channels are additional. Add 10% for 42mm and 15% for 50mm. Freight is additional.

LENGTH	WIDTH							
	24"	36"	48"	60"	72"	84"	96"	108"
24"	1,485	1,577	1,669	1,761	1,853	1,945	2,036	2,128
36"	1,537	1,602	1,686	1,795	1,868	1,962	2,055	2,149
48"	1,588	1,628	1,698	1,802	1,975	1,979	2,075	2,170
60"	1,640	1,680	1,720	1,809	1,892	1,996	2,094	
72"	1,691	1,731	1,771	1,813	1,902	2,014		
84"	1,743	1,783	1,823	1,864	1,904			
96"	1,794	1,834	1,874	1,916				
108"	1,846	1,886	1,926					

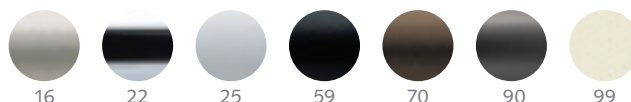

Mercury Motorized Direct Mount

ASSEMBLED PRICING includes one of our six stock fabrics, 38mm tube, motor, micro usb cable to charge battery, brackets, bracket covers, counterweight or bottom rail with end cap and remote. Side channels are additional. Add 10% for 42mm and 15% for 50mm. Freight is additional.

LENGTH	WIDTH							
	24"	36"	48"	60"	72"	84"	96"	108"
24"	778	822	866	911	956	1,000	1,044	1,088
36"	804	834	880	927	963	1,008	1,053	1,098
48"	829	848	883	931	970	1,016	1,062	1,108
60"	855	874	892	934	974	1,025	1,071	
72"	881	899	918	937	979	1,033		
84"	907	925	944	963	981			
96"	932	951	969	988				
108"	958	977	995					

Mercury Roller Shade Finishes

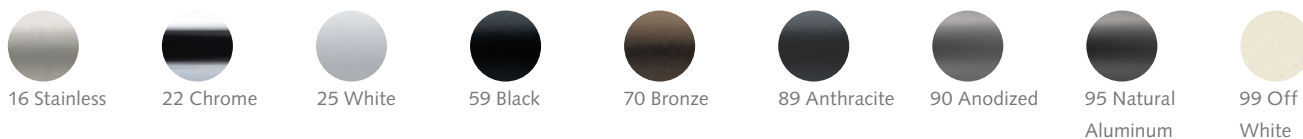

Mercury Motorized In Stock Fabric Options

74002-99 3% Solar Fabric Off White width = 118 in. length = 27 yds.	74003-55 3% Solar Fabric Light Grey width = 98 in. length = 32 yds.	74004-97 3% Solar Fabric Oyster width = 98 in. length = 30 yds.	74001-98 Blackout Fabric Ivory width = 100 in. length = 32 yds.	74005-01 Blackout Fabric Frost width = 118 in. length = 30 yds.	74006-08 Blackout Fabric Ash width = 118 in. length = 30 yds.

Hundreds of fabric options are available in our Eclipse fabric collection. Call sales for a quote.

Mercury Motorized Decorative Roller Shades *NEW!*

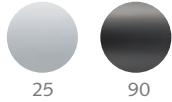

Mercury Motorized Basic Mount

ASSEMBLED PRICING includes one of our six stock fabrics, 38mm tube, headrail, motor, micro usb cable to charge battery, brackets, bracket covers, counterweight or bottom rail with end cap and remote. Side channels are additional. Add 10% for 42mm and 15% for 50mm. Freight is additional.

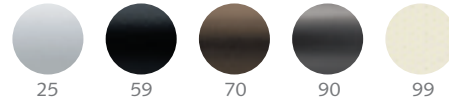

Mercury Motorized Semi Open Mount

ASSEMBLED PRICING includes one of our six stock fabrics, 38mm tube, cassette, motor, micro usb cable to charge battery, brackets, bracket covers, counterweight or bottom rail with end cap & remote. Side channels are additional. Add 10% for 42mm and 15% for 50mm. Freight additional.

LENGTH	WIDTH							
	24"	36"	48"	60"	72"	84"	96"	108"
24"	802	859	915	972	1,029	1,085	1,142	1,198
36"	828	872	932	991	1,038	1,095	1,153	1,210
48"	854	884	935	995	1,046	1,105	1,164	1,223
60"	879	910	941	999	1,051	1,115	1,175	
72"	905	936	967	998	1,057	1,125		
84"	931	962	992	1,024	1,054			
96"	957	987	1,018	1,049				
108"	982	1,013	1,044					

LENGTH	WIDTH							
	24"	36"	48"	60"	72"	84"	96"	108"
24"	820	880	941	1,001	1,062	1,122	1,183	1,243
36"	846	895	958	1,022	1,071	1,133	1,194	1,256
48"	871	906	962	1,026	1,081	1,144	1,206	1,269
60"	897	932	966	1,030	1,085	1,154	1,218	
72"	923	957	992	1,027	1,092	1,165		
84"	949	983	1,018	1,053	1,088			
96"	974	1,009	1,044	1,079				
108"	1,000	1,035	1,069					

Mercury Roller Shade Finishes

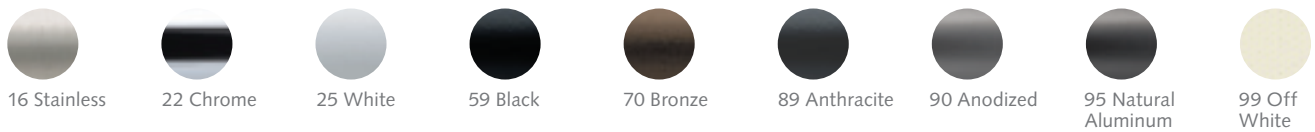

Mercury Motorized In Stock Fabric Options

74002-99 3% Solar Fabric Off White width = 118 in. length = 27 yds.	74003-55 3% Solar Fabric Light Grey width = 98 in. length = 32 yds.	74004-97 3% Solar Fabric Oyster width = 98 in. length = 30 yds.	74001-98 Blackout Fabric Ivory width = 100 in. length = 32 yds.	74005-01 Blackout Fabric Frost width = 118 in. length = 30 yds.	74006-08 Blackout Fabric Ash width = 118 in. length = 30 yds.

Hundreds of fabric options are available in our Eclipse fabric collection. Call sales for a quote.

MOTORIZATION – Mercury Roller Shades

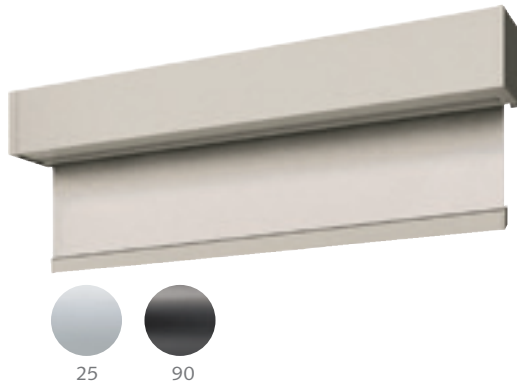

Mercury Motorized Square Mount

ASSEMBLED PRICING includes one of our six stock fabrics, 38mm tube, cassette, motor, micro usb cable to charge battery, brackets, bracket covers, counterweight or bottom rail with end cap and remote. Side channels are additional. Add 10% for 42mm and 15% for 50mm. Freight is additional.

LENGTH	WIDTH							
	24"	36"	48"	60"	72"	84"	96"	108"
24"	850	926	1,001	1,077	1,152	1,228	1,303	1,378
36"	876	942	1,022	1,101	1,163	1,240	1,317	1,394
48"	902	951	1,026	1,106	1,175	1,253	1,331	1,410
60"	927	977	1,027	1,111	1,180	1,266	1,346	
72"	953	1,003	1,052	1,103	1,188	1,279		
84"	979	1,029	1,078	1,128	1,178			
96"	1,005	1,054	1,104	1,154				
108"	1,030	1,080	1,130					

GREAT FEATURE!
Use the channel on the bottom of the profile to hang a sheer drapery!

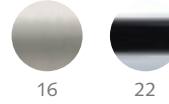
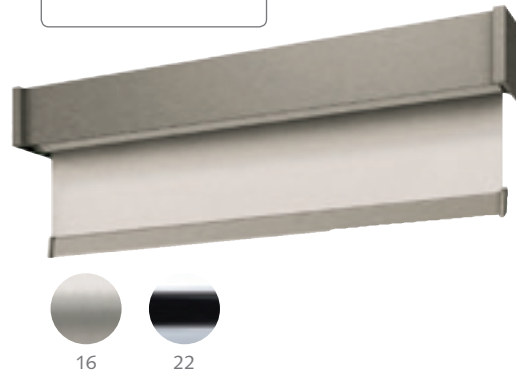

Mercury Motorized Ultimate Mount

ASSEMBLED PRICING includes one of our six stock fabrics, 38mm tube, cassette, motor, micro usb cable to charge battery, brackets, bracket covers, counterweight or bottom rail with end cap and remote. Side channels are additional. Add 10% for 42mm and 15% for 50mm. Freight is additional.

LENGTH	WIDTH							
	24"	36"	48"	60"	72"	84"	96"	108"
24"	947	1,041	1,135	1,229	1,323	1,417	1,511	1,606
36"	973	1,063	1,162	1,261	1,338	1,434	1,530	1,626
48"	998	1,067	1,168	1,268	1,353	1,451	1,548	1,646
60"	1,024	1,092	1,161	1,274	1,360	1,467	1,567	
72"	1,050	1,118	1,186	1,255	1,370	1,484		
84"	1,076	1,144	1,212	1,281	1,349			
96"	1,101	1,170	1,238	1,307				
108"	1,127	1,195	1,264					

Mercury Motorized Tube Sizes, Motor, and Control Options

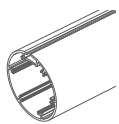

77001-90
Aluminum Tube, 19'
50mm
\$12.27/ft.

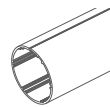

77002-90
Aluminum Tube, 19'
42mm
\$8.77/ft.



77003-90
Aluminum Tube, 19'
38mm
\$4.53/ft.



78000-25
Motor
and lithium battery
\$451.39 ea.



78001-25
38 mm Drive
for Mercury Motor
\$15.39 ea.



78002-25
38 mm Crown Adaptor
for Mercury Motor
\$4.65 ea.



78003-25
Micro USB Cable
for Mercury Motor
3 meters, white
\$19.65 ea.



78004-59
Remote
for Mercury Motor
5 channel, black
\$97.22 ea.

See page 74 for all Mercury Roller Shade components

FOREST
Atlantis



Atlantis Tube Sizes



815019-00
50 mm aluminum tube, 19"
for shades up to 10' wide
\$12.16/ft.



816019-00
60 mm aluminum tube, 19"
for shades up to 12' wide
\$15.06/ft.

Atlantis Control Options

The Atlantis system can be controlled by the 6-channel Diamond Remote used alone, or in combination with a wireless wall switch. Shades can be operated in a group or individually. A timer is included.



52931-25D white
52931-59D black
-59 Black +10%
Diamond Remote
RF, 6 channel
w/ holder
\$208.73 ea.



52933-25 white
52933-59 black
-59 Black +10%
Diamond Wall
Switch
2 channel
\$159.06 ea.



52943-25 white
52943-59 black
-59 Black +10%
RF Multi Wall
Switch, 16 channel
LED screen
\$272.84 ea.

Atlantis® Motorized HD Roller Shades

Tubular motorized roller shade system in 50 or 60 mm with internal multi receiver and electronic limit setting. Maximum total weight is 45 lbs with a 6 Nm motor. Noise level < 44 dB. Easy installation with universal adjustable brackets. Use intermediate brackets to install multiple blinds on a single motor. Patent Pending.

ASSEMBLED PRICING includes motor, brackets, tube, end cap, bottom profile, weight for bottom profile, end cap for bottom profile, 3% solar fabric (unless blackout is specified), cassette (if specified) and Diamond remote or Diamond wall switch. Freight is additional.

2"/50mm Direct Mount Assembled Pricing (+ 20% for 60 mm)

LENGTH	WIDTH						
	24"	36"	48"	60"	72"	84"	96"
24"	\$936.48	\$992.91	\$1,049.32	\$1,105.74	\$1,122.72	\$1,139.71	\$1,156.69
36"	\$953.34	\$1,018.38	\$1,083.29	\$1,148.20	\$1,173.67	\$1,199.13	\$1,224.62
48"	\$970.45	\$1,043.85	\$1,117.25	\$1,190.66	\$1,224.62	\$1,258.58	\$1,292.55
60"	\$987.43	\$1,069.33	\$1,151.21	\$1,233.10	\$1,275.56	\$1,318.01	\$1,360.47
72"	\$1,004.41	\$1,094.79	\$1,185.18	\$1,275.56	\$1,326.51	\$1,377.46	\$1,428.41
84"	\$1,021.40	\$1,120.28	\$1,219.14	\$1,318.01	\$1,377.46	\$1,436.89	\$1,496.32
96"	\$1,038.38	\$1,145.74	\$1,253.10	\$1,360.47	\$1,428.41	\$1,496.32	\$1,564.25
108"	\$1,055.36	\$1,171.22	\$1,287.07	\$1,402.94	\$1,479.35	\$1,555.77	\$1,632.18
120"	\$1,072.34	\$1,196.69	\$1,321.04	\$1,445.39	\$1,530.29	\$1,615.19	\$1,700.11
132"	\$1,089.32	\$1,222.17	\$1,355.00	\$1,487.84	\$1,581.24	\$1,674.65	\$1,768.04
144"	\$1,106.30	\$1,247.63	\$1,388.96	\$1,530.29	\$1,632.18	\$1,734.08	\$1,835.97

2"/50mm Cassette Mount Assembled Pricing (+ 20% for 60 mm)

LENGTH	WIDTH						
	24"	36"	48"	60"	72"	84"	96"
24"	\$1,050.21	\$1,118.66	\$1,187.11	\$1,255.56	\$1,324.01	\$1,392.46	\$1,460.91
36"	\$1,067.06	\$1,144.14	\$1,221.08	\$1,298.02	\$1,375.10	\$1,452.18	\$1,529.26
48"	\$1,084.18	\$1,169.61	\$1,255.04	\$1,340.47	\$1,425.90	\$1,511.33	\$1,596.76
60"	\$1,101.16	\$1,195.09	\$1,289.00	\$1,382.93	\$1,476.87	\$1,570.80	\$1,664.73
72"	\$1,118.13	\$1,220.55	\$1,322.97	\$1,425.39	\$1,527.80	\$1,630.22	\$1,732.64
84"	\$1,135.12	\$1,246.04	\$1,356.94	\$1,467.84	\$1,578.75	\$1,689.66	\$1,800.57
96"	\$1,152.10	\$1,271.50	\$1,390.90	\$1,510.29	\$1,629.68	\$1,749.08	\$1,868.48
108"	\$1,169.09	\$1,296.98	\$1,424.86	\$1,552.75	\$1,680.64	\$1,808.53	\$1,936.42
120"	\$1,186.07	\$1,322.45	\$1,458.83	\$1,595.21	\$1,731.60	\$1,867.98	\$2,004.37
132"	\$1,203.05	\$1,347.93	\$1,492.80	\$1,637.65	\$1,782.53	\$1,927.41	\$2,072.29
144"	\$1,220.04	\$1,373.40	\$1,526.75	\$1,680.13	\$1,833.49	\$1,986.85	\$2,140.22

Atlantis Motorized In Stock Fabric Options



74002-99
3% Solar Fabric
Off White
width = 118 in.
length = 27 yds.



74003-55
3% Solar Fabric
Light Grey
width = 98 in.
length = 32 yds.

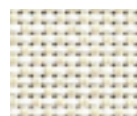

74004-97
3% Solar Fabric
Oyster
width = 98 in.
length = 30 yds.

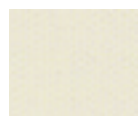

74001-98
Blackout Fabric
Ivory
width = 100 in.
length = 32 yds.

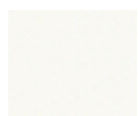

74005-01
Blackout Fabric
Frost
width = 118 in.
length = 30 yds.



74006-08
Blackout Fabric
Ash
width = 118 in.
length = 30 yds.



Hundreds of fabric options are available in our Eclipse fabric collection. Call sales for a quote.

Atlantis Motorized Heavy Duty Roller Shades Components



62901-25
Forest Tubular Motor
built-in RF receiver,
35mm, 110v, 6 Nm
\$549.32 ea. 1/box



810119-25
Side Guide Profile. 19'
\$12.16/ft.



810000-00
Brush
\$1.86/ft.



810219-25
Bottom Profile
\$4.48/ft.



810001-25
Weight Profile
\$6.84/ft.



810319-25
Cassette Cover, 19'
\$12.43/ft.



810019-25
Plastic Adhesive Strip
\$2.14/ft.



810419-25
Foam Strip for Blackout
.12" x .79" (3 x 20 mm)
\$14.22/ft.



810519-25
Foam Strip
.79" x .79" x 40"
(20 x 20 x 1000 mm)
\$12.16/ft.



82CL01-25 Left
82CR01-25 Right
Standard Ceiling/Wall
Idler Brackets
\$44.55 ea.



820003-25
Middle Adjustable
Ceiling Cassette
Idler Bracket
\$54.51 ea.



82CL00-25 Left
82CR00-25 Right
Standard Ceiling/Wall
Motor Bracket
\$27.08 ea.



820004-25
Middle Adjustable Ceiling
Connecting Bracket
\$45.80 ea.



820005-25
Middle Adjustable Ceiling
Cassette Connecting
Bracket
\$49.88 ea.



830001-25
Bracket End Cap
\$3.25 ea.



830002-25
Middle Bracket Cover
\$3.11 ea.



830003-25
End Cap Guide
Profile
\$2.22 ea.



830004-25
End Cap Bottom
Profile
\$1.04 ea.



835000-00
Motor Adaptor
50 mm
\$25.91 ea.



835001-00
Idler
50 mm
\$2.56 ea.



835002-00
Connector Idler
50 mm
\$2.56 ea.



835003-00
Adjustable Idler
50 mm
\$31.92 ea.



836000-00
Motor Adaptor
60 mm
\$30.19 ea.



836001-00
Idler
60 mm
\$4.15 ea.

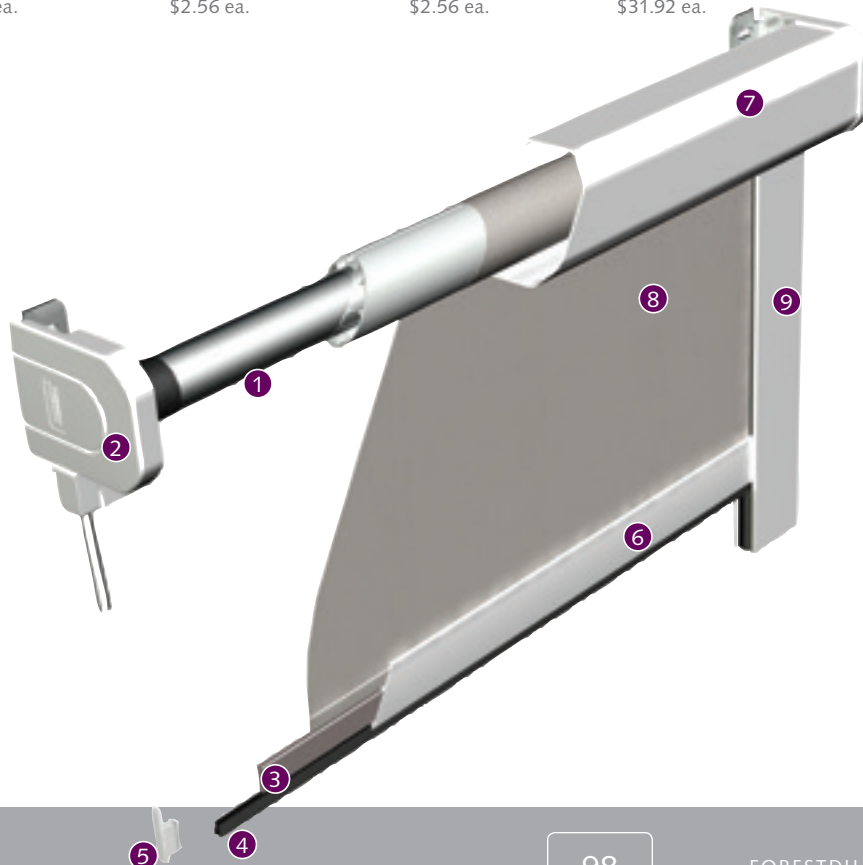

- ① 50 or 60 mm Tube
- ② End Cap
- ③ Weight for Bottom Profile
- ④ Brush
- ⑤ End Cap for Bottom Profile
- ⑥ Bottom Profile
- ⑦ Cassette Cover
- ⑧ 3% Solar Fabric
or Blackout Fabric
- ⑨ Side Guide Profile (optional)

10 WARRANTY
year

The Forest Atlantis Tubular Motor
has a 10-year warranty.

MOTORIZATION – Atlantis Roller Shades

Terms & Conditions

FOREST DRAPERY HARDWARE

2500 DONN DRIVE • CARTERSVILLE GA 30120 • P 678.605.0432 • F 678.823.3894

Applicant, to induce Forest Drapery Hardware (FDH) to consider providing goods on credit to Applicant, hereby agrees for itself, its successors, and permitted assigns, that the following terms and conditions shall apply to all sales of goods (the "Goods") by FDH to applicant.

1. Applicant is applying for credit for business purposes. Applicant authorizes all financial institutions and business entities of which FDH may from time to time make inquiry to provide FDH such financial information, as FDH deems necessary to make credit decisions. FDH has no obligation to extend credit to Applicant and may in its sole discretion suspend, terminate or reduce the limits of any extensions of credit at any time and withhold shipments of Goods ordered, or require cash in advance, in the event FDH, in its sole discretion, finds Applicant's financial condition to be unsatisfactory.
2. FDH will provide to Applicant an itemized invoice for each sale. If Applicant does not give written notice to FDH within seven (7) calendar days from the date of such invoice of any objection to the Goods listed, the receipt thereof, that such purchase was unauthorized or any other objection, all such objections shall be deemed waived. Applicant waives any and all right to set off claims, which it may assert against FDH, and/or to withhold payment to FDH based on a claim that FDH is indebted to Applicant. No claim asserted by Applicant against FDH shall relieve Applicant of its obligation to make timely payments to FDH.
3. Except as otherwise set forth in a FDH Invoice, payment is due by the 30th day following the date of the invoice. Payments become past due after the 30th day. Applicant agrees that all amounts in past due shall bear interest at 1.5% per month pre- and post-judgement until paid and agrees to pay FDH, in addition to the amount due, attorneys' fees of fifteen percent (15%) of the amount due, or the maximum amount allowed by law, whichever is greater, in the event the account is placed in collections with an attorney, or any other means of collection, and also to pay any and all attorneys' fees and costs associated with post-judgement collection preparation and recording fees. Applicant agrees that all payments shall be applied to Applicant's account as designated in writing and if not designated in writing then FDH shall apply said payments to the most outstanding invoices. This Agreement shall be deemed fully executed and performed in Bartow County, Georgia, and will be governed and construed in accordance with the laws of Georgia. Applicant agrees to examine all invoices and statements promptly upon receipt and to notify FDH immediately at any failure of delivery, shortage, discrepancy or error and further agrees that such invoice or statement shall be presumed correct unless Applicant shall notify FDH in writing of such failure of delivery, shortage, discrepancy or error within three (3) calendar days of Applicant's receipt of such invoice or statement. Use of materials by Applicant shall constitute a waiver of any error in shipment or defect in materials, which might have been determined by a prompt and diligent inspection thereof.
4. Any waiver or non-enforcement by FDH of a breach, default or term under this Agreement shall not be deemed a waiver of any subsequent breach or default of enforcement of such term and FDH shall only be deemed to have given as much in writing executed by FDH providing for such waiver. If any provision of this Agreement is waived by FDH or is held to be invalid or unenforceable, all other provisions shall nevertheless continue in full force and effect as if such provision were not contained herein.
5. This Agreement contains the entire agreement and understanding between FDH and Applicant with respect to the sale of Goods by FDH to Applicant (other than payment terms and delivery dates to be set forth in FDH invoices), supersedes all prior agreements, commitments, representations and discussions between FDH and Applicant and is not assignable by Applicant without the prior written consent of FDH. No modifications, amendments or additions to this agreement will be binding on FDH unless such modification, amendment or addition is in writing executed by FDH. Without limitation of the foregoing, the terms hereof shall not be modified, amended or added to by the terms of any purchase order or similar document submitted by Applicant to FDH. The terms here of shall be altered or interpreted by reference to any course of dealing between FDH and Applicant of industry practice. Any action by Applicant instituted against FDH arising from Goods sold must be commenced within one (1) year from date of delivery of the subject of Goods.
6. **Applicant shall have three (3) calendar days from the date of delivery to reject Goods as nonconforming.** Such rejection must be in writing received by FDH within such three (3) calendar days, and specify the Goods rejected and the specific nonconformity asserted and the subject **Goods must be received by FDH within ten (10) calendar days from the delivery date of Goods.** Any goods returned, except goods damaged in shipping, shall be in original packaging with all instructions, if any, and unused. Returns not properly packaged that result in product not being in sellable condition will not be accepted for return. All Goods not so rejected shall conclusively be deemed to have been accepted. In order to effect such rejection, the Goods returned must be accompanied by a copy of the original invoice or other proof of purchase by Applicant. No charges or expenses incident to any claims will be allowed unless approved by an authorized representative of FDH. Goods shall not be returned to FDH without FDH permission and such returns will only be accepted when return authorization numbers, given by FDH, is mentioned on the Goods and bill of lading. Physical acceptance by FDH of Goods returned may in no way be deemed agreement by FDH of any claim by Applicant of nonconformity.
7. FDH shall have a reasonable time after receipt of proper notice of rejection of nonconformity Goods of revocation of acceptance of nonconformity Goods to repair or replace the Goods or refund the purchase price, with the remedy to be selected by FDH in its sole discretion. If Applicant otherwise has an outstanding balance, the refund shall be in the form of a credit to Applicant's account.
8. Applicant is responsible for determining the Goods it chooses to purchase and for what purposes those Goods will be used and Applicant will not be relying on the skill or judgment of FDH to select or furnish Goods suitable for any particular purpose. FDH MAKES NO REPRESENTATIONS OR WARRANTIES, EXPRESS OR IMPLIED, INCLUDING BUT NOT LIMITED TO WARRANTIES OF FITNESS OR SUITABILITY FOR ANY PURPOSE, AND/OR THE MERCHANTABILITY OF ANY GOODS. Applicant agrees that its sole and exclusive remedy against FDH for defective or nonconforming Goods shall be repair or replacement of such Goods, or refund of purchase price, with the remedy to be selected by FDH at its sole discretion. Applicant hereby waives all other remedies, and in no event shall FDH be liable for any negligence or general, incidental, special, consequent or other damages suffered by Applicant or any other party for lost profit, sales, labor, injury to person or property or any other loss. FDH may deliver certain third-party manufacturer warranties to Applicant, but FDH shall have no liability under such warranties.
9. The undersigned unconditionally personally guarantees the timely payment of all amounts due from Applicant to FDH and agrees to be jointly and severally liable with the Applicant to FDH for any debt owed by the Applicant, The undersigned agrees to pay reasonable attorneys' fees equal to 15% of the outstanding principal and interest owed by the Applicant in the event that the Applicant's account is placed in collections with an attorney or any other means of collection. This personal guarantee may only be revoked in writing sent by certified mail to FDH. Said revocation shall not be effective as to any balance owned prior to receipt of said revocation. The undersigned hereby expressly waives notice of acceptance of this instrument, notice of any default, non-payment, partial payment, presentment, protest, demand and any and all other notices whatsoever.

Returns, Warranty & Care

FOREST DRAPERY HARDWARE
 2500 DONN DRIVE • CARTERSVILLE GA 30120 • P 678.605.0432 • F 678.823.3894

FREIGHT/SHIPPING
 Orders will be shipped via the most economical way. Freight charges will be added to invoice.

RETURNS
 All returns must be approved prior to returning by requesting an RGA authorization number. A 25% restocking fee will be applied. No returns accepted after 30 days of receipt of order or on custom orders. Goods must be in new and in original packaging.

PAYMENT
 We accept Visa, Mastercard, American Express & Discover Card. Our invoice price is for check payment. We reserve the right to add a convenience fee for credit card payments. Credit is available upon submittal and approval of a credit application.

SHORTAGES/DAMAGES
Please inspect all packages upon receipt, note any loss or damages on the freight company's delivery receipt prior to the driver before leaving. Failure to correctly sign for damaged goods as damaged may impact your right to request a freight claim or replacement order. Immediately notify Forest Drapery Hardware. Claims must be reported within 3 business days.

WARRANTY
 Forest Drapery Tracks are warranted for 10 years. Forest Motors are warranted for 10 years with the exception of the Forest Lithium Battery Tubular Motor for RBS which is warranted for 1 year. Forest Roller Shades are warranted for 1 year. Warranties do not apply to wear resulting from normal usage, damage from mishandling, alterations from original state, abuse, or exposure due to climate conditions over which we have no control. No Forest products are warranted for outdoor use.

CARE
 Products can be cleaned with a damp cloth. Do not use any type of cleaner or solvent.

Child Safety

FOREST DRAPERY HARDWARE ADHERES TO ALL SAFETY REQUIREMENTS AS DIRECTED BY WCMA.



You will see this symbol throughout the catalog identifying corded products. All Forest custom assembled products containing cords meet ANSI 5.2 child safety standards and include a tension device and a warning label like the one below.

CHILD SAFETY
 PAGE 100

WARNING

Window Blind Cord Can STRANGLE Your Child

- Children can climb furniture to reach cords.
- Move crib and furniture away.
- Keep all cords out of children's reach.
- Attach tension device to wall or floor.
- Fasteners provided with the tension device may not be appropriate for all mounting surfaces.
- Use appropriate anchors for the mounting surface conditions.

Ripplefold® Carrier Count Charts

For Overlap Masters

APPENDIX – Carrier Count Charts

No. of Full Spaces Required	Fabric Width Hemmed	Panel Coverage 120% Fullness	Panel Coverage 100% Fullness	Panel Coverage 80% Fullness	Panel Coverage 60% Fullness	* No. of Carriers
7	35 1/2	11-14	12-16	14-17	14-19	8
9	44	15-18	17-20	18-22	20-24	10
11	52 1/2	19-21	21-24	23-27	25-30	12
13	61	22-25	25-28	28-32	31-35	14
15	69 1/2	26-29	29-32	33-36	36-40	16
17	78	30-33	33-37	37-41	41-45	18
19	86 1/2	34-36	38-41	42-46	46-51	20
21	95	37-40	42-45	47-51	52-56	22
23	103 1/2	41-44	46-50	52-55	57-61	24
25	112	45-48	51-54	56-60	62-66	26
27	120 1/2	49-51	55-58	61-65	67-72	28
29	129	52-55	59-62	66-70	73-77	30
31	137 1/2	56-59	63-66	71-74	78-82	32
33	146	60-63	67-71	75-79	83-87	34
35	154 1/2	64-66	72-75	80-84	88-93	36
37	163	67-70	76-79	85-89	94-98	38
39	171 1/2	71-74	80-84	90-93	99-103	40
41	180	75-78	85-88	94-98	104-108	42
43	188 1/2	79-81	89-92	99-103	109-114	44
45	197	82-85	93-96	104-108	115-119	46
47	205 1/2	86-89	97-101	109-112	120-124	48
49	214	90-93	102-105	113-117	125-129	50
51	222 1/2	94-96	106-109	118-122	130-135	52
53	231	97-100	110-113	123-127	136-140	54
55	239 1/2	101-104	114-118	128-131	141-145	56

No. of Full Spaces Required	Fabric Width Hemmed	Panel Coverage 120% Fullness	Panel Coverage 100% Fullness	Panel Coverage 80% Fullness	Panel Coverage 60% Fullness	* No. of Carriers
57	248	105-108	119-122	132-136	146-150	58
59	256 1/2	109-111	123-126	137-141	151-156	60
61	265	112-115	127-130	142-146	157-161	62
63	273 1/2	116-119	131-136	147-150	162-166	64
65	282	120-123	137-139	151-155	167-171	66
67	290 1/2	124-126	140-143	156-160	172-176	68
69	299	127-130	144-147	161-165	177-182	70
71	307 1/2	131-134	148-152	166-169	183-187	72
73	316	135-138	153-156	170-174	188-192	74
75	324 1/2	139-141	157-160	175-179		76
77	333	142-145	161-164	180-184		78
79	341 1/2	146-149	165-168	185-188		80
81	350	150-153	169-173	189-193		82
83	358 1/2	154-156	174-177			84
85	367	157-160	178-181			86
87	375 1/2	161-164	182-186			88
89	384	165-168	187-190			90
91	392 1/2	169-171				92
93	401	172-175				94
95	409 1/2	176-179				96
97	418	180-183				98
99	426 1/2	184-186				100
101	435	187-190				102

* Includes one carrier (button position only) for attachment to master.
Ripplefold is a trademark of Kirsch.

Ripplefold® Carrier Count Charts

For Butt Masters

No. of Full Spaces Required	Fabric Width Hemmed	Panel Coverage 120% Fullness	Panel Coverage 100% Fullness	Panel Coverage 80% Fullness	Panel Coverage 60% Fullness	* No. of Carriers
7	34	13-13	13-14	13-16	16-18	8
9	42 1/2	14-16	15-19	17-21	19-23	10
11	51	17-20	20-23	22-26	24-28	12
13	59 1/2	21-24	24-27	27-30	29-34	14
15	68	25-28	28-31	31-35	35-39	16
17	76 1/2	29-31	32-36	36-40	40-44	18
19	85	32-35	37-40	41-45	45-49	20
21	93 1/2	36-39	41-44	46-49	50-55	22
23	102	40-43	45-48	50-54	56-60	24
25	110 1/2	44-46	49-53	55-59	61-65	26
27	119	47-50	54-57	60-64	66-70	28
29	127 1/2	51-54	58-61	65-68	71-76	30
31	136	55-58	62-65	69-73	77-81	32
33	144 1/2	59-61	66-70	74-78	82-86	34
35	153	62-65	71-74	79-83	87-91	36
37	161 1/2	66-69	75-78	84-87	92-97	38
39	170	70-73	79-82	88-92	98-102	40
41	178 1/2	74-76	83-87	93-97	103-107	42
43	187	77-80	88-91	98-102	108-112	44
45	195	81-84	92-95	103-106	113-118	46
47	204	85-88	96-99	107-111	119-123	48
49	212 1/2	89-91	100-104	112-116	124-128	50
51	221	92-95	105-108	117-121	129-133	52
53	229 1/2	96-99	109-112	122-125	134-139	54
55	238	100-103	113-116	126-130	140-144	56

No. of Full Spaces Required	Fabric Width Hemmed	Panel Coverage 120% Fullness	Panel Coverage 100% Fullness	Panel Coverage 80% Fullness	Panel Coverage 60% Fullness	* No. of Carriers
57	246 1/2	104-106	117-121	131-135	145-149	58
59	255	107-110	122-125	136-140	150-154	60
61	263 1/2	111-114	126-129	141-144	155-160	62
63	272	115-118	130-133	145-149	161-165	64
65	280 1/2	119-121	134-138	150-154	166-170	66
67	289	122-125	139-142	155-159	171-175	68
69	297 1/2	126-129	143-146	160-163	176-181	70
71	306	130-133	147-150	164-168	182-186	72
73	314 1/2	134-136	151-155	169-173	187-191	74
75	323	137-140	156-159	174-178	192-196	76
77	331 1/2	141-144	160-163	179-182		78
79	340	145-148	164-167	183-187		80
81	348 1/2	149-151	168-172	188-192		82
83	357	152-155	173-176	193-197		84
85	365 1/2	156-159	177-180			86
87	374	160-163	181-184			88
89	382 1/2	164-166	185-189			90
91	391	167-170	190-193			92
93	399 1/2	171-174				94
95	408	175-178				96
97	416 1/2	179-181				98
99	425	182-185				100
101	433 1/2	186-189				102
103	442	190-193				104

* Includes one carrier (button position only) for attachment to master.
Ripplefold is a trademark of Kirsch.

Marketing Support



Product Catalogs

The Forest product catalog contains over 100 pages of product available in our Atlanta warehouse. Forest catalogs are available for purchase, or contact your sales manager to discuss having a custom catalog printed just for your company.

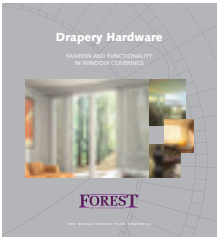

Decorative Hardware Finish Swatch Binder

The Forest finish swatch binder contains physical samples of each finish in our decorative metal and wood collections, a swatch card of our in-stock roller shade fabrics, and a product catalog.

999001-00 \$100.00 each



Roller Shade Fabric Swatch Card & Binder

The Forest roller shade fabric swatch card allows you to see and feel 3 solar fabrics and 3 blackout fabrics in stock. **SHADESWATCH** \$21.94 each

The Forest fabric swatch binder contains more that 100 roller shade fabrics available to order. **ECLIPSE**. \$100.00 each



Drapery Hardware Sample Board Wall Display

Boards - acrylic board with hardware set attached, 25 1/4" x 3 7/8"

B0005-00. \$100.00 each

Rails - mount on your wall to display hardware sample boards.

Set of two rails holds 11 boards, height = 53 1/8".

B0008-00. \$75.00/set of 2 rails



Starter Marketing Kit for your Showroom

Kit includes a box of 40 Catalogs, a Finish Swatch Binder, a Fabric Swatch Binder, a Wall Display with 10 hardware samples, and a Motorized sample featuring a track, metal, wood or shade of your choice. This kit is valued at \$1,745 and Forest will take it back in 150 days if it does not sell for you.

STARTER MARKETING KIT \$500 each

Technical Support



Forest Website – forestdh.com

- Spec Sheets & Catalog forestdh.com/FGUSAdownloads.html
- Assembly & Installation Instructions forestdh.com/supportFG.html
- Technical Manuals forestdh.com/TechnicalManuals.html

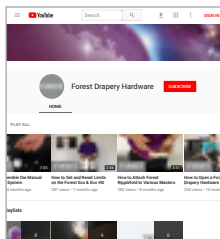

Forest YouTube Channel

- Programming, Assembly, Tips & Tricks youtube.com/user/forestdrapery



Product Training with a Forest Regional Sales Manager

Forest sales managers will train you and your customers at your facility or ours.
Call today to schedule a group presentation, lunch & learn or open house –
866-823-3894.



Phone Support – 866-823-3894

8:30 am - 5:30 pm ET Monday thru Friday

FASHION AND FUNCTIONALITY IN WINDOW COVERINGS

WWW.FORESTDH.COM

For a distributor in your area go to www.forestdh.com
or call 866-823-3894.

© Copyright 2019 Forest Drapery Hardware

All returns must be approved prior to returning. A 25% restocking fee will be applied. No returns accepted after 30 days of receipt of order or on custom orders. Please inspect all packages upon receipt, note any loss or damage on the freight bill and immediately notify Forest Drapery Hardware. Claims must be reported within three business days. Forest Drapery Tracks are warranted for 10 years. All Forest Shuttle motors and the Forest Atlantis motor are warranted for 10 years. All other motors are warranted for 1 year. Forest Roller Shades are warranted for 1 year. Warranties do not apply to wear resulting from normal usage, damage from mishandling, abuse, or exposure due to climate conditions over which we have no control. No Forest products are warranted for outdoor use. All prices subject to change without notice. *Ripplefold is a trademark of Kirsch.

FOREST
DRAPERY HARDWARE